

HUGO GERNSBACH,  
Editor

*In this Issue-*  
Two New FM Tuners  
Audio-Frequency Wattmeter

# RADIO CRAFT



MAKING NEW TUBES  
FOR FM RECEIVERS  
SEE PAGE 28



DEC  
1947

30¢  
CANADA-35¢

RADIO-ELECTRONICS IN ALL ITS PHASES



## This New IRC JUNIOR Control Cabinet Belongs on Your Bench

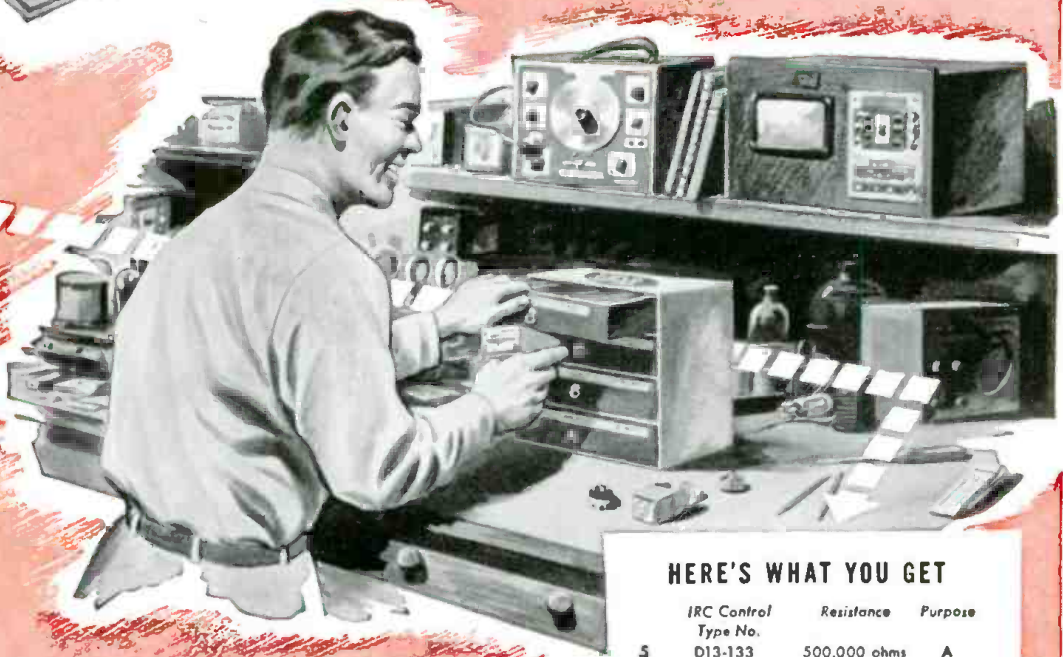

Here's one selection of 9 "hot-number" controls, switches and shafts you'll use every day! The new IRC Junior Control Cabinet contains 9 of the most-used 1/2, 1 and 2 meg. type D controls with the added adaptability of the tap-in shaft feature—plus 4 switches and 4 special shafts.

This inexpensive assortment of popular controls will save you time and money, and reduce your need for exact replacements. Factory-packed in a handsome four drawer cabinet of sturdy cardboard. Cabinet attractively finished in blue, yellow and silver with twelve individually identified compartments. Order the new inexpensive JUNIOR Control Cabinet from your IRC Distributor today. International Resistance Company, 401 N. Broad Street, Philadelphia 8, Pennsylvania. In Canada: International Resistance Company, Ltd., Toronto, Licensee.

### HERE'S WHAT YOU GET

	IRC Control Type No.	Resistance	Purpose
5	D13-133	500,000 ohms	A
1	D13-133X	500,000 ohms	B
1	D13-137	1.0 meg.	A
1	D13-137X	1.0 meg.	B
1	D13-139	2.0 meg.	A

Purpose: A-Tone or Audio Circuit control;  
B-Topped for tone compensation.

### SWITCHES

0	#41	S.P.S.T.
1	#42	D.P.S.T.

### SHAFTS

1 Type "A" double-flatted tap-in shaft is included with each control—plus:

3 Type "E" with universal knurl for special type push on knobs.

1 Type "H" with universal groove for many Delco, RCA, Sears-Roebuck and Westinghouse models.

INTERNATIONAL RESISTANCE COMPANY



Wherever the Circuit says 





# I Will Show You How to Learn RADIO by Practicing in Spare Time

I Send You Big Kits of Radio Parts



**KIT 1**  
I send you Soldering Equipment and Radio parts; show you how to do Radio soldering; how to mount and connect Radio parts; give you practical experience.



**KIT 2**  
Early in my course I show you how to build this N.R.I. Tester with parts I send. It soon helps you fix neighborhood Radios and earn EXTRA money in spare time.

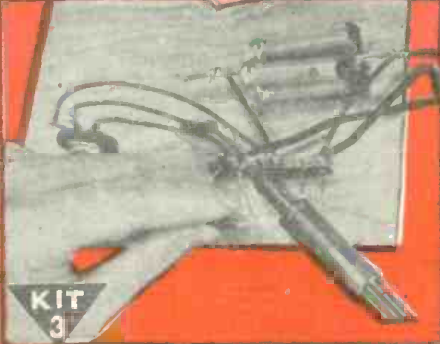

**KIT 3**  
You get parts to build Radio Circuits; then test them; see how they work; learn how to design special circuits; how to locate and repair circuit defects.

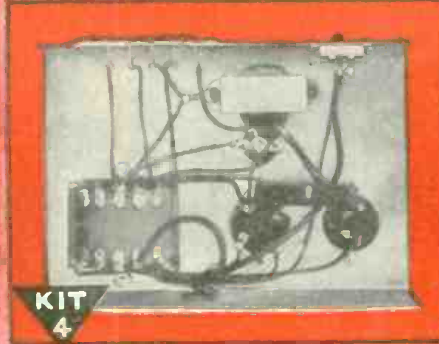

**KIT 4**  
You get parts to build this Vacuum Tube Power Pack; make changes which give you experience with packs of many kinds; learn to correct power pack troubles.



**KIT 5**  
Building this A. M. Signal Generator gives you more valuable experience. It provides amplitude-modulated signals for many tests and experiments.



**KIT 6**  
You build this Superheterodyne Receiver which brings in local and distant stations—and gives you more experience to help you win success in Radio.

## I Will Train You at Home - SAMPLE LESSON FREE

Do you want a good-pay job in Radio—or your own money-making Radio Shop? Mail Coupon for a FREE Sample Lesson and my FREE 64-page book, "How to Be a Success in RADIO—Television, Electronics." See how N.R.I. gives you practical Radio experience at home—building, testing, repairing Radios with BIG KITS OF PARTS I send!

**Future for Trained Men Is Bright in Radio, Television, Electronics**  
It's probably easier to get started in Radio now than ever before because the Radio Repair business is booming. Trained Radio Technicians also find profitable opportunities in Police, Aviation, Marine Radio, Broadcasting, Radio Manufacturing, Public Address work. Think of even greater opportunities as Television and Electronics become available to the public! Send for free books now!

**Find Out What N.R.I. Can Do for You**  
Mail Coupon for Sample Lesson and my 64-page book. Read the details about my Course. Read letters from men I trained, telling what they are doing, earning. See how quickly, easily you can get started. No obligation! Just MAIL COUPON NOW in an envelope or paste it on a penny postal. J. E. SMITH, President, Dept. 7NX, National Radio Institute, Pioneer Home Study Radio School, Washington 9, D. C.

**Many Beginners Soon Make Good Extra Money in Spare Time While Learning**

**Our 33rd Year of Training Men for Success in Radio**  
My training includes TELEVISION • ELECTRONICS • F M

The day you enroll I start sending EXTRA MONEY manuals. You LEARN Radio principles from my easy-to-grasp, illustrated lessons—PRACTICE what you learn with parts I send—USE your knowledge to make EXTRA money fixing neighbors' Radios in spare time while still learning! From here it's a short step to your own full-time Radio Shop or a good Radio job!

**Good for Both - FREE**  
Mr. J. E. SMITH, President, Dept. 7NX  
National Radio Institute, Washington 9, D. C.  
Mail me FREE, without obligation, Sample Lesson and 64-page book about how to win success in Radio and Television—Electronics. (No salesman will call. Please write plainly.)



**VETERANS**  
You can get this training right in your own home under G. I. Bill.  
Mail coupon for full details.

Age .....

Name .....

Address .....

City ..... State .....

(Please include Post Office Zone number)

APPROVED FOR TRAINING UNDER GI BILL



## What's The Indian Rope Trick Got To Do With MALLORY CAPACITORS?

MALLORY originated and produced the first type "FP" capacitor. These have been famous for performance for so long—have been so consistently preferred for original equipment—it follows they naturally become first choice of radio servicemen. You might imagine there was some special magic in their making.

The popularity of FPs, however, has never depended on tricks of engineering or manufacture. Yesterday, as today, it has been a matter of *quality*. Careful control of materials . . . painstaking manufacturing methods that keep impurities down to a fraction of a part per million . . . rigid standards of testing and inspection . . . explain why Mallory FPs are preferred.

They are the reasons why Mallory FP capacitors *last* . . . why millions are in use all over the world . . . why they can be counted upon for service beyond the normal. They are your assurance that when you install a Mallory FP, the customer can depend on a job well done.



YOU EXPECT MORE AND GET MORE FROM MALLORY

P. R. MALLORY & CO. Inc.  
**MALLORY**

VIBRATORS . . . VIBRAPACKS\* . . . CAPACITORS . . . VOLUME  
CONTROLS . . . SWITCHES . . . RESISTORS . . . FILTERS  
. . . RECTIFIERS . . . POWER SUPPLIES.

\*Reg. U. S. Pat. Off.

APPROVED PRECISION PRODUCTS

P. R. MALLORY & CO., Inc., INDIANAPOLIS 6, INDIANA

# NEW!

**in 1,000 pages:**

**All data and basic knowledge in radio and electronics digested into 12 sections... in a complete, quick to find, easy to read, handbook form.**

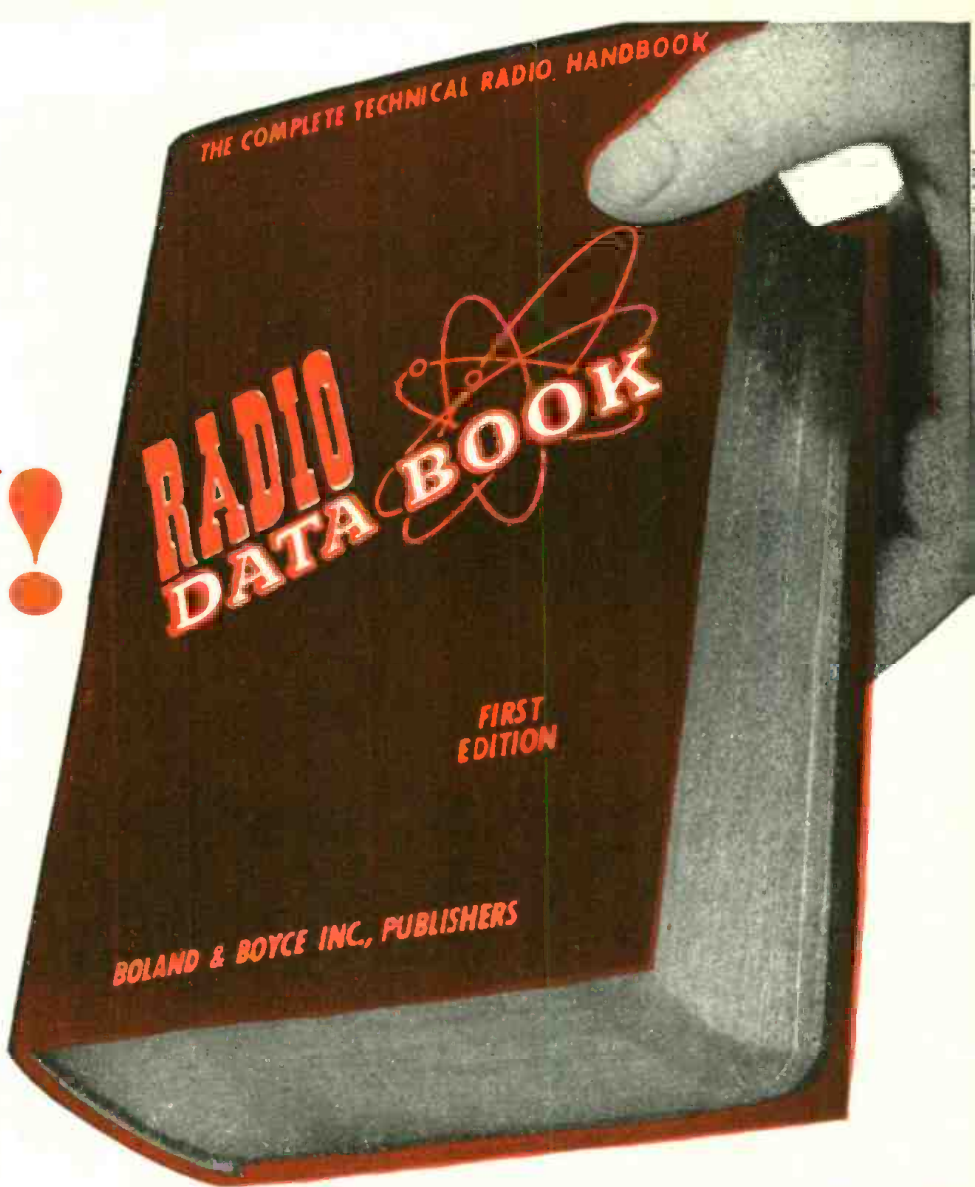

Plan every operation in radio and electronics with the *Radio Data Book*. This new radio bible will be your lifelong tool . . . you will use it every day, on the board, at the bench, in the field! Use it for construction, troubleshooting and testing. The RADIO DATA BOOK will be your invaluable aid in design, experiment and in layout. It will help make your production better, faster and easier. In any and every operation in radio and electronics, you will use the RADIO DATA BOOK!

**Handsomely bound in RED and GOLD**

The RADIO DATA BOOK is a work of complete authority, prepared by engineers with many years of practical experience. They have been assisted by the Boland & Boyce staff of editors skilled in preparing electronics manuals for the U. S. Signal Corps for many years. These men have worked for several years gathering material for this book . . . all the knowledge of radio principles and operation . . . all the statistics . . . all the newest developments in electronics . . . every possible angle and detail. Eighteen months were spent digesting this material into the most concise, the clearest, and the most readable form. The result is this invaluable manual . . . The RADIO DATA BOOK. Whether you use this book for general reference, for scientific instruction, or for education, one thing is certain—the practical help, the daily usefulness you will derive from it will prove to be worth many, many times its astonishingly low price!

Advanced Sale . . . first printing, Only 10,000 available . . . To make sure to get your RADIO DATA BOOK, mail your order **NOW!**

**CONTENTS**

Each section is a COMPLETE coverage of its subject . . . 12 sections . . . 12 books in ONE! 1000 pages . . . Schematics . . . Accurate photographs . . . Specially prepared drawings . . . White on black charts . . . Diagrams . . . Isometric projections and exploded views.

**Section 1. THE 150 BASIC CIRCUITS IN RADIO.**  
Every circuit is analysed and explained in a Johnny-on-the-spot reference for any occasion.

**Section 2. COMPLETE TEST EQUIPMENT DATA.**  
Know more about the test instruments you now have . . . Find the new ones you want to buy . . . They're All in here—impartially described!

**Section 3. TESTING, MEASURING AND ALIGNMENT.**  
Simplified operation of the Oscilloscope . . . See what's happening inside any radio circuit . . . Dynamic alignment—AM, FM and TELEVISION made easy with the Oscilloscope . . . Scientific use of the Vacuum Tube Voltmeter, Signal Generating Equipment and other basic instruments.

**Section 4. ALL ABOUT ANTENNAS.**  
AM-FM-Television . . . design, installation, characteristics, construction and feed.

**Section 5. SOUND SYSTEMS.**  
Planning, installing and servicing a PA System. A complete chapter on every component . . . How to select and combine components . . . estimating costs . . . even acoustic requirements!

**Section 6. ELECTRICAL AND PHYSICAL CHARACTERISTICS OF RADIO COMPONENTS.**  
Know the size, the power, the shop! A quick reference on the construction and design of any circuit or equipment.

**Section 7. COMPLETE TUBE MANUAL.** Receiving, transmitting and Commercial.  
A flick of the pages brings you to all the data and ratings of any tube model

**Section 8. CHARTS, GRAPHS AND CURVES.**  
Quick calculation devices . . . Plotting curves, nomographs, rules and tables for speedy solutions to radio problems.

**Section 9. CODES, SYMBOLS AND STANDARDS.**  
Handy reference to all radio symbols and abbreviations; code symbols, phrases and characters . . . Where you want them . . . When you want them!

**Section 10. 50 TESTED CIRCUITS DESIGNED FOR OPTIMUM PERFORMANCE.**  
Find any circuit you want with complete parts lists and specifications . . . One tube receivers to complete AM, FM and Television receiver circuits . . . Amplifiers . . . Transmitters . . . Test Equipment and Control Circuits . . . All with the latest engineering refinements.

**Section 11. DICTIONARY OF RADIO AND ELECTRONIC TERMS.**

**Section 12. RADIO BOOK BIBLIOGRAPHY.**

**12 complete books in one only \$5.00! Less than 42c per book!**

**MAIL THIS COUPON TODAY!**

**BOLAND & BOYCE INC., PUBLISHERS**  
**460 BLOOMFIELD AVE. MONTCLAIR 3, N. J.**

Please send me a copy of

**THE RADIO DATA BOOK** Enclosed is \$5.00.

NAME .....

ADDRESS .....

CITY .....

ZONE .....

STATE .....

**BOLAND & BOYCE INC., PUBLISHERS**

# NEW RIDER BOOKS OPEN UP NEW OPPORTUNITIES FOR YOU!

## JUST OUT! FM

by John F. Rider & Seymour D. Usher

### CHAPTER HEADS

- Fundamental Considerations
- Frequency Modulation
- Essentials of F-M Transmitters
- Transmitters of Today (Wide Band and Narrow Band)
- The Transmission of F-M Signals
- F-M Receiving Antennas
- The F-M Receiver
- Alignment of F-M Receivers
- Servicing of F-M Receivers

Over 300 Fact-Packed Pages

TWO EDITIONS:

(Same but for covers) **\$1.80**  
Paper Cover Stack.....**\$2.70**  
Hard Back Cloth.....

### TRANSMISSION AND RECEPTION

A thorough explanation of all manufacturers' products—transmitting and receiving; regular broadcasting, railroad, police, and "ham" equipment. Wide medium and narrow band is considered.

For radio servicemen, who can look to F.M. as a big part of their future profits, for the "ham" who is considering narrow band F.M.—for the student who is grooming himself for activity in the electronic field, this new book explains both the theory and servicing of F.M. receivers. Its text provides an equally valuable hand-book for engineers.

Here is technical know-how that will enable you to benefit from the fast growing manpower needs of the electronic industries. Rider Radio Books have proved their practical value in servicing shops, "ham" shacks, engineering labs., public libraries, government and private schools and colleges. They are authoritative, and easily understood. Check the listing below. Order today—and begin to "Learn RIGHT with Rider."

## JUST OUT! TWO NEW RIDER 99's

### PA INSTALLATION AND SERVICING

Here is a book that provides the answers to characteristic problems met in low-power public address installations. In short it tells what to do and what not to do with microphones, amplifiers, loud speakers, connecting cables—also how to service such PA systems.

### UNDERSTANDING VECTORS AND PHASE

Considering the importance and wide use of vector presentations as a short-hand method of conveying the latest technical information in the radio field, it behooves every man in the technical branch of the industry to possess an appreciation of the significance of vectors. This book is a must for every student and serviceman if he is to keep pace with and understand advances in the radio art.

Each Over 130 Pages.....**Each ONLY 99¢**  
WATCH FOR EARLY RELEASE OF ADDITIONAL RIDER 99'S

## BROADCAST OPERATORS HANDBOOK

by HAROLD E. ENNES

A practical book written by a well known broadcast station operator for others who seek to attain high positions in that branch of electronics. 280 pages—**\$3.30.**

OUT IN  
JANUARY!

### INSIDE THE VACUUM TUBE



By John F. Rider. A new approach and technique that makes its message easy to understand. A solid, elementary concept of the theory and operation of the basic types of vacuum tubes based on the electro static field theory. The book, which covers diodes, triodes, tetrodes, and pentodes, presents a clear physical picture of exactly what is happening in a vacuum tube.

A goldmine for the student; a must for servicemen, amateurs and engineers. 425 Pages—\$4.50.

### SERVICING BY SIGNAL TRACING



Explains approved system of diagnosing faults in radio receivers and all kinds of communication systems. The method was introduced by the author of the book, John F. Rider. The system has won endorsement by individuals and associations the world over as well as technical branches of our government. 360 Pages—188 Illustrations—\$4.00. Spanish edition—\$4.00.

### A-C CALCULATION CHARTS

By R. LORENZEN. Students and engineers will find this book invaluable. Simplifies and speeds work involving AC calculations. Contains 146 charts. Covers AC calculations from 10 cycles to 1000 megacycles. —\$7.50

### THE METER AT WORK



How each type of meter works and how each is used in the field to best advantage. Covers whichever phase of the subject the reader is interested in. 152 Pages—138 Illustrations—\$2.00.

### VACUUM TUBE VOLTMETERS



Explains the theory upon which the functioning of the different types of v-t voltmeters is based, and also the practical applications of these instruments. Includes a bibliography consisting of 145 international references. 180 Pages—111 Illustrations—\$2.50.

### THE CATHODE-RAY TUBE AT WORK



By JOHN F. RIDER. Presents a complete explanation of the various types of cathode-ray tubes and what role each element within the device plays in making voltages and currents visible. The only book of its kind! 338 Pages. 450 Illustrations—\$4.00.

### SERVICING RECEIVERS BY RESISTANCE MEASUREMENT

Discusses series and parallel combinations of resistances and the distribution of currents and voltages, providing the basis underlying the circuit arrangements used in various types of radio receivers. 203 Pages—94 Illustrations—\$2.00.

### ALIGNING PHILCO RECEIVERS



Complete and detailed information for aligning every Philco model from 1929 to 1941.

VOL. I—1929 to 1936—176 Pages.....\$2.00

VOL. II—1937 to 1941—200 Pages.....\$2.00

### UNDERSTANDING MICROWAVES

By VICTOR J. YOUNG. Foundation for understanding microwave radio and radar. Explained simply. Design and Operation of waveguides, magnetrons, klystrons, antennas, etc. Section I covers theory; Section II, terms, ideas, and theorems. 385 Pages. Liberally Illustrated. \$6.00.

### RADAR

The complications have been removed in this entertaining book explaining Radar. Non-technical, but authentic. 80 pages, profusely illustrated, only \$1.00.

### THE OSCILLATOR AT WORK



Shows how various oscillator circuits function and methods to improve their performance. Also describes the r-f and o-f oscillators used as signal sources. Covers laboratory test methods, and other related tests. 256 Pages—167 Illustrations—\$2.50.

### AUTOMATIC FREQUENCY CONTROL SYSTEMS



Basic operation of discriminator and Automatic Frequency control circuits is detailed in first part of book. Descriptions of systems used in commercial receivers are fully described in second part. 144 Pages—102 Illustrations—\$1.75.

## JOHN F. RIDER PUBLISHER, Inc.

404 FOURTH AVENUE,  
NEW YORK 16, N. Y.

(Dept. B)

Export Agent: Rocke International  
Corp., 13 E. 40th Street, N. Y. C.  
Cable ARLAB

Publishers of  
RIDER MANUALS

AN HOUR A DAY WITH RIDER SERIES—96 PAGES.....(each) \$1.25

**D.C. VOLTAGE DISTRIBUTION IN RADIO RECEIVERS**—The applications of Ohm's law, practically interpreted in terms of how circuits are employed in radio receivers.  
**"ALTERNATING-CURRENTS IN RADIO RECEIVERS"**—This book familiarizes you with the different forms of alternating currents in receivers. Basic facts.  
**RESONANCE AND ALIGNMENT**—The importance of the subject in relation to all communication systems, and the clarity of this text, have sold over 60,000 of this title.  
**AUTOMATIC VOLUME CONTROL**—An easy to understand explanation of how avc is utilized in radio receivers.

CHECK  
THE BOOKS  
YOU NEED  
AND GET  
THEM,  
TODAY!

## LEARN RIGHT WITH RIDER!

FOR 17 YEARS PUBLISHERS EXCLUSIVELY FOR THE RADIO AND ELECTRONIC INDUSTRIES

I'll Send You 8 Big Kits of Training Equipment  
including

**TWO-BAND 6 TUBE SUPER RECEIVER**  
**AND 16 RANGE METER SET-UP**  
for Testing

Learn Fast . . . Earn Fast  
**HOME TRAINING**  
Planned For Your Needs  
You Build All These  
**TESTERS . . . and MORE!**



**Practice Does It!**  
Soldering, wiring, connecting Radio Parts . . . building circuits with your own hands — you can't beat this method of learning. When you construct this Rectifier and Filter Resistor and Condenser Tester, etc., you get a really practical slant on Radio that leads to a money-making future.

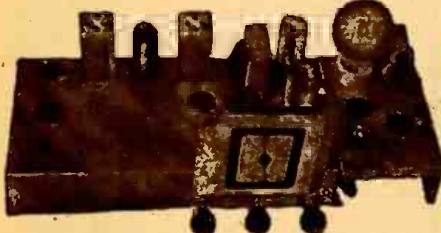

Building this Signal Generator and multi-purpose Tester will give you the kind of valuable experience and practice that is so important as a foundation for making good money in Radio. It makes a breeze out of fixing Radios, and you don't have to spend money on ready-made Equipment.

**VETERANS**

APPROVED FOR G.I. TRAINING  
UNDER PUBLIC LAW 346.



**PRACTICE WITH YOUR OWN HANDS!**  
Mind training through hand practice, that's the only way to LEARN and REMEMBER Radio. It's the most successful of Home Training methods.

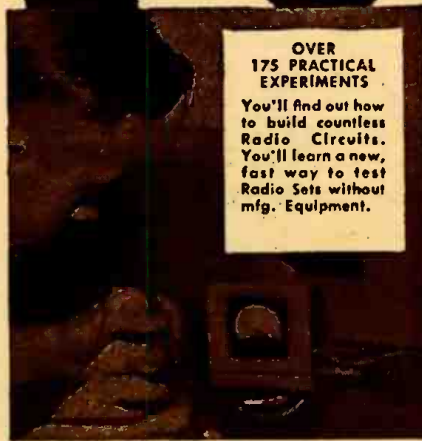

**OVER 175 PRACTICAL EXPERIMENTS**  
You'll find out how to build countless Radio Circuits. You'll learn a new, fast way to test Radio Sets without mfg. Equipment.

**LOW COST HOME RADIO TRAINING!**  
**Easy Monthly Payments!**

My perfected Radio Training prepares you to start your own Radio Service Shop—or to land a big pay Radio job. With my help you get neighborhood Radio jobs while learning—for extra cash and rich experience. I train you RIGHT—by putting you to work with your hands in your own home during spare hours. You get 8 big kits of real professional Radio Parts and Equipment—and use them to build, test and trouble-shoot a powerful 6 tube superhet receiver, a 16 range test meter set-up and over 175 fascinating, instructive Radio experiments. My training is down-to-earth, really PRACTICAL—it's the Training you need to make

money in Radio. Theory is cut to the bone—you don't need any previous schooling or experience. Sprayberry Training starts you out at the very beginning of Radio—the lessons are completely illustrated, simply written and easy to understand.

Get the facts about Sprayberry Training NOW. Find out what it can do for you—prepare for amazing opportunities in Radio Servicing, Television, FM, Radar and Industrial Electronics. Fill out and mail coupon for my two big Books—FREE. No obligation—and no salesman will call. Mail coupon TODAY!

**MAIL COUPON FOR THESE 2 BOOKS!**



"How to Read Radio Diagrams and Symbols" and "How to Make Money in Radio, Electronics and Television." Immense, practical value to you — and they're yours FREE!

SPRAYBERRY ACADEMY OF RADIO  
F. L. Sprayberry, President  
Room 20127, Pueblo, Colorado

Please rush my FREE copies of "How to MAKE MONEY IN RADIO, ELECTRONICS and TELEVISION" and "How to READ RADIO DIAGRAMS and SYMBOLS."

Check here if a Veteran

Name \_\_\_\_\_ Age \_\_\_\_\_

Address \_\_\_\_\_

City \_\_\_\_\_ State \_\_\_\_\_

(Mail in envelope or paste on penny postcard)

## Tuning Units

From BC 191 & BC 375  
TU 6B, 3000 kc to 4500  
kc, TU 9B-7700 to 10,000  
Kc, TU 10B-10,000 to  
12,500 Kc, TU 22 B- 350

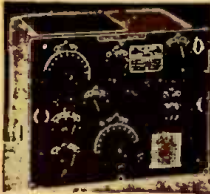

Units C or F. Each ..... \$2.75  
Units A,B,E. Each ..... \$2.00

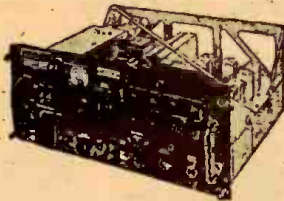

**BC 1207 TRANSMITTER & RECEIVER NEW.** 1 KV pulse oscillator on 154 to 188 mc. Can be converted to CW or Voice operation on 144 to 148 mc. band. Receiver is a superhet with 2 stages of RF, 5-stagger tuned IF stages. Plenty of room on chassis for additional changes, with tubes. New ..... \$75.00

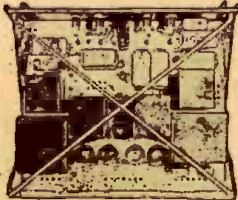

**POWER SUPPLY RA105 A NEW.** Input: 117 V. 60 c.p.s. Output: 2000 VDC - 2000 VDC. 610 VDC. 415 VDC. 300 VDC. 290 VDC. -160 VDC. and 6.3 VAC 60 c.p.s. with tubes. Now ..... \$40.00

**INDICATOR I-221. NEW.** Remote antenna direction control roller & indicator, using 2 electron motors. 360 deg. rotation. Operates on 117 VAC. 60 c.p.s. with tubes. Now ..... \$50.00

Mounting rack (FM79) for above 3 units with blower. APX size 4'x2'x2' ..... \$35.00

Control unit BC 1073. Consists of pulse generator, and a wavemeter which measures frequencies from 150 to 210 mc. The pulse generator makes an excellent square-wave generator with variable pulse-widths. The wavemeter can be modified into a UHF oscillator. 117 VAC. 60 c.p.s. operation ..... \$50.00

**ANTENNA. AN 128 A-NEW.** 2 parallel vertical dipoles working against a square reflector. Impedance is 50 ohms. Broad band pass. Makes an ideal antenna, with high gain & directivity on 2 meters APX 5'x4' \$40.00

Complete Set RC 148 Xmtr & Rcvr BC 1267 & power supply RA. 105. Both units with tubes. used, in excellent condition ..... \$47.50

## COMPLETE TRANSMITTER AND RECEIVER RC145

BC 1267 RA 105 A, Indicator I 221, may be operated as independent units, or the complete set of components combined to form a unit may be purchased at this special price—with mounting rack FM 79, crated \$190.00 Gov't cost, \$5000

## MacKay Radio Transmitter

Model 167-BY. A CW Xmtr with range 2 to 24 mc. Power output: 200 Watts from 2 to 16 mc, 150 Watts from 16 to 24 mc. Complete, with 110 VDC rotary power supply ..... \$350.00

## Cross Pointer Indicator

Two 0-200 microampere movements, 3" case, many applications ..... \$2.50

**FINEST QUALITY**

# "Communications"

**LOWEST PRICES**



## GIBSON GIRL EMERGENCY XMTR

Transmits automatic SOS signal on 500 kc emergency wave. Can be manually keyed to transmit additional information. No Batteries required. Hand cranked. \$25.00

## R4-ARR2 RECEIVER

UHF receiver, approx. 300 mc with following tubes, 7-9001's, 3-6AK5's, 1-12A6. New ..... \$17.50  
W/dynamotor ..... \$19.20  
Less dynamotor W/xfmr for filaments ..... \$19.00

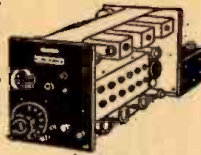

## INTERFERENCE REDUCER, BC 736B (RCA)

Used to reduce interference in radio receiver BC 403 D. Many uses. Tubes: 3-6AC7, 1-5T4, 1-6H6, 1-6AG7. \$14.50

## Test Set 159TPX

Measures frequency between 150 & 200 Mc. by heterodyne method. Pwr. Output of XMTR can be measured directly. Measures DC voltages up to 500 V. Operates on 110 V. 400 cy, but mere replacement of power xfmr makes it operable on 110 V. 60 cy. Complete with tubes, crystal, calibration chart. New ..... \$50.00



## MOTOR DRIVEN SWITCH

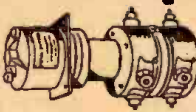

Switch operates at 1800 rpm, using internal 24 VDC motor. Switch is DPDT, and was originally designed for automatic switching of YAGI radar antenna \$2.00



## MC ELLROY TG-10 KEYS

Makes excellent code practice machine, using tape or key. Variable words-per-minute adjustment. Clean, quick keying, using photocell. Operates on 110 V. 60 cycle. Slightly used, but in excellent condition. Less tubes ..... \$15.00

## RAK-7 RECEIVERS

15 to 600 kc. 6-tube receiver with AVC. Band Pass Audio Filter, Noise Limiter. Precision tuning with Vernier dial. Voltage regulated power supply with 3 tubes for 115 volts, 60 cycle. Can be battery operated. New. Comes in 5 cases with spare parts, extra tubes, auxiliary equipments, etc. .... \$75.00

## RADIO-SONDE XMTR.

### T-49/AMT1

Operates on 72.2 Mc. Good unit for portable fly-weight XMTR or walkie-talkie. May be modified for 6 or 2 meter operation. In its own container. New, Complete, with 3A5 tube. \$27.50



## TRANSFORMERS

(All Primaries 117 V, 60 cy) Filament Xfms:

# 5058: sec #1: 6.3V @ 3 A CT @ sec #2: 6.3V @ 2 A T \$2.45  
# 5128: 5 V @ 3 A CT, 5 V @ 2 A ct, 5 V @ 6 A CT ..... \$3.25  
# 5100: 6.3 V CT @ 1.2 A, 5000 volt test ..... \$2.45  
# 5085: 6.3 V N.T. @ .8 A, 6.3V NCT @ 1.5 A \$1.95  
# 5037: 6.3 VCT, 1c A, 5 VCT @ 3 A, 5 VCT @ 3 A ..... \$2.75  
# LX 0899: 5 V @ 5.5 A, 7.5 V @ 5.5 A, 85, 500 V test ..... \$24.50

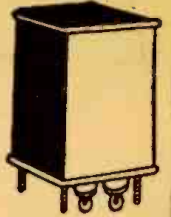

## VIBRATOR TRANSFORMER

Input: 24 v, 12 v, or 6 v. Output: Two 120 v windings @ .175 amp. Plus 11 v winding. Ea. .... \$1.50

**SPECIAL** transformer to supply filaments of equipments using 12-volt tubes, Input: 117 V 60 cy. Output: 28 Volts @ 2 A ..... \$1.50

## CHOKES

6 Hy @ 150 Ma. .... \$2.00  
1 Hy @ 300 Ma ..... \$4.50  
Dual choke, 2-2 Hy @ 100 ma ..... \$8.95  
Dual choke, 7 Hy @ 75 Ma, 11 Hy @ 60 Ma ..... \$1.95

## DYNAMOTORS

PE 78 CM. Power supply for BC 375. Input: 28 VDC. Output: 1000 VDC @ 350 Ma. Starting relay, filter, etc. .... \$4.95  
Mfrs.: Write for quantity, prices & discounts on above items.  
D 77KM. Power supply for BC 191. Input: 14 VDC. Output: 1000 VDC @ 850 Ma. New, with spare fuse links, etc. .... \$5.95  
PE 101C. Input: 13/26 VDC @ 12.6/6.3 A. Output: 400 VDC @ 185 Ma., 800 VDC @ 20 Ma. (9VAC @ 1.12 A.) ..... \$3.49  
PE 86 N. Input: 28 VDC Output: 250 VDC @ 60 Ma. Westinghouse w/Filter ..... \$1.95  
Without Filter ..... \$1.60  
PC 77. Input: 12 VDC. Output 275 VDC @ 110 Ma. 500 VDC @ 50 Ma. .... \$3.25  
DAG 33 A; Input: 18 VDC @ 3.2 A. Output: 150 VDC @ 60 Ma. .... \$2.15  
DM 33A. Input: 28 VDC @ 7 A. Output: 640 VDC @ 250 Ma. Power supply for modulator or SCR 274 N. .... \$3.95  
Dyn. Model 23350. Input 27 VDC @ 1.75 A. Output: 285 VDC @ 75 Ma. .... \$1.75  
DM-21. In 14VDC 3.3A Out 285VDC 90 ma with filter ..... \$2.59  
DM-25: In 12VDC 2.3A Out 250VDC 50 ma. .... \$2.49  
DM-84: In 14VDC 2.8A Out 220VDC 80 ma. .... \$2.49  
DM-42: In 14VDC. Out 515/1030 VDC 215/260 ma & 2/8 VDC ..... \$3.95  
BD-77 input 14VDC, output 1000V 350ma DC ..... \$5.95  
Motor-Gen. PU43/A Input: 24-28 VDC @ 62 A. Output: 415 VAC @ 7 A., 800 Cycles/sec. \$15.00

## OIL CONDENSERS

.25 mf @ 20000 VDC Aerovox \$17.50  
.15 mf @ 600 VDC Aerovox. \$12.50  
10 mf @ 27KV. .... \$75.00  
.01 mf @ 25 KV. .... \$25.00

## MICA

.08 mf @ 1500 VDC. Sbrakox MX60 \$11.50  
.03 mf @ 2000 VDC. CD 551A-50 ..... \$12.75  
.045 mf @ 2000 VDC. Sangamo, G1 ..... \$12.75  
00015 mf @ 20 KV. Aerovox 1070-404 ..... \$25.00  
0001 mf @ 20 KV. Sangamo G3 ..... \$25.00  
0051 mf @ 15KV. Sangamo G4 ..... \$25.00  
006 mf @ 10 KV. Sangamo G3 ..... \$17.50  
002 mf @ 15 KV. Sangamo ..... \$20.00  
isolating Capacitor. Cornell-Dubilier Pl. 1417 100-110 mmf @ 10KV AC (Peak) Each. .... \$3.50

MFRS: Send your requirements for bathubs, Micacs, Hardware, resistors, & connectors.

## HEADSETS

Dynamic mike and Headset combination. A high quality, efficient unit, used in B-19 tank Xmtrs. Mike & phones complete, new ..... \$2.75  
HS 30 HEADSET: A feather-weight headset with insert type phones that cut background noises to a minimum. Low impedance (500 ohms) assures efficiency & high fidelity. 5.85 Matchline transformer to match 500 ohms to 5000 ohms output ..... \$3.35  
R-15 headsets: 8000 ohms impedance, rubber cushions. Comes with 8' cord & plug Pl. 55; New ..... \$1.95  
Used, in good condition ..... \$1.60



All merchandise guaranteed. Mail orders promptly filled, prices F.O.B. N. Y. C. Send Money Order or Check. Rated Concerns send P.O. Shipping charges only send C.O.D. Send for Flyers.

# COMMUNICATIONS EQUIPMENT CO.

131-C LIBERTY ST., NEW YORK 7, N.Y. TELEPHONE DIGBY-9-4124



E. B. De Vry, President  
DeForest's Training, Inc.

HERE'S *your*  
**Big Chance**



## Profit Through Training in RADIO-ELECTRONICS

Prepare at HOME or in our CHICAGO LABORATORY to get REAL MONEY, a BETTER JOB, or a BUSINESS OF YOUR OWN . . . .

Our business is helping men . . . and young men . . . get into a well-paying future in the highly profitable fields of RADIO-ELECTRONICS. During the past sixteen years we have trained many men who desired better jobs or businesses of their own. We can effectively provide you with this same opportunity either in our new, modern Chicago laboratories or in the privacy of your own home.

If you choose to come to Chicago, we shall find comfortable living quarters for you. If you train at home, we shall send you modern, practical equipment. In either of these two methods, you will have the supervision of some of the finest instructors in the country. Fill in coupon below and we shall send you, absolutely FREE, full information about our program of building men for better opportunities in RADIO-ELECTRONICS. DeForest's Training, Inc. also includes instruction in FM Radio, Television and Industrial Electronics.

If you prefer to remain at home, you receive eight (8) big kits of radio parts and assemblies from which you can work out dozens of fascinating radio circuits to gain practical experience in your own home. In addition, you receive a 16 mm. motion picture projector and 12 information-packed reels of film which help you learn faster . . . easier. You also get modern looseleaf lessons with handy fold-out diagrams.

### VETERANS

Both our (1) Chicago Laboratory and (2) Home Study training are accepted under the "G. I. Law." If you qualify, the Government will pay cost of either training you select.

### EMPLOYMENT SERVICE

When you complete your training our effective Employment Service helps you get started toward a real future. Mail coupon below today . . . do not delay.

**MAIL THIS OPPORTUNITY COUPON NOW!**

Mr. E. B. De Vry, President  
DeForest's Training, Inc.  
2533 N. Ashland Ave., Dept. RC-D12  
Chicago 14, Illinois

Please show me how I may get started toward a good job or a business of my own in Radio-Electronics.

Name.....Age.....

Address.....Apt.....

City.....Zone.....State.....

If under 16, check here for special information.

If a discharged Veteran of World War II check here.

# DEFOREST'S TRAINING, INC.

Affiliated with the De Vry Corporation  
CHICAGO • ILLINOIS



**ANOTHER NATIONAL**

**FIRST**

**THE NC-183**

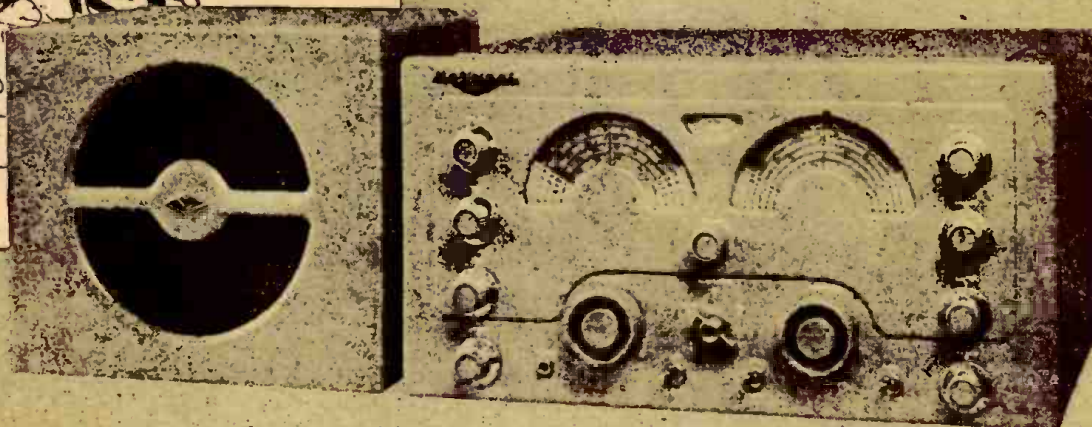

**FEATURES:**

- Frequency coverage from 0.54 to 31 Mc Plus 6 meter band. Band-switching on all frequencies.
- Adjustable sensitivity control for S-meter operation on either c.w. or phone.
- Automatic adjustable threshold double-diode noise limiter.
- 115 volts 50/60 cycle AC operation. Easily adapted to 230 volts.
- Amateur Net (Complete with 10" speaker) .....\$269.00

For the first time, a ham receiver incorporating all the latest innovations demanded by amateurs is now available at a reasonable price.

The NC-183, latest in National's great new line of communications receivers, is a band-switching set covering frequencies from 0.54 to 31 MC plus the 6 meter band. Two r.f. amplifier stages provide remarkable image rejection and the latest crystal filter aids in maintaining the highest degree of selectivity.

In addition, a stabilized voltage regulated circuit makes the NC-183 a truly top-flight performer on the highest frequencies. A push-pull audio output stage with separate 10" speaker affords excellent fidelity of output.

These, plus many other features, combine to make the NC-183 a really "hot" receiver. It will certainly become a strong favorite with those stations that specialize in digging DX out of the background.

See and hear the NC-183 at your nearest National distributor this week.

**National  
Company, Inc.**

**Dept. No. 75  
Malden, Mass.**

**MAKERS OF LIFETIME RADIO EQUIPMENT**

**WE BRING NATIONAL SCHOOLS  
TO YOU FOR HOME TRAINING IN  
RADIO  
TELEVISION & ELECTRONICS**



RADIO SHOP AT NATIONAL

BROADCAST STUDIO AT NATIONAL

Partial View of the Facilities that Stand Behind Your National Schools Home Training

TELEVISION STUDIO AT NATIONAL



Since 1905

**For Over 42 Years  
One of America's  
Leading Trade Schools**

**NATIONAL SCHOOLS SHOP METHOD  
HOME TRAINING WILL START YOU RIGHT**

We will train you today to get started tomorrow in one of the thousands of opportunities opening in the field of Radio, Television and Electronics. The Home Radio Service Field continues to grow. Television is here . . . Television Broadcasting facilities are being rapidly expanded. Television sales, service, installation and maintenance requirements are more and more important from day to day. Electronics is an important factor in many applications for utility, safety, accuracy and convenience. Airlines are finding new uses for Radio bringing new benefits to air transportation. Ships at sea are employing Radar together with other conventional Radio apparatus for ship-to-shore communications and safety. Frequency Modulation is modernizing Radio Broadcasting, offering static-and-interference-free reception in the home. The list of Radio applications is almost endless, and every one represents increasing opportunities in our modern world for the **RADIO, TELEVISION AND ELECTRONICS TECHNICIAN WITH A SOLID TECHNICAL BACKGROUND.**

**YOU CAN BE A NATIONAL SCHOOLS MAN**

It is not a question of opportunity but rather how to take advantage of existing opportunity. Only proper training can make these opportunities a reality. National Schools of Los Angeles, one of the oldest and largest technical trade schools in the United States, offers you Shop Method Home Training, a proved method that builds qualified technicians. Here is Home Training that **BRINGS RESULTS.**

Behind all training from National Schools stands a permanent faculty of experienced instructors and engineers. These men are daily teaching resident students right in our own Shops and Laboratories. From first hand experience with students here at school, our instructors understand the needs and ambitions of men like you. All of our instructors, both Home Study and Resident, have ideal facilities to make your training practical, up-to-the-minute, interesting. It takes years of experience to know how to train men, especially in the practical technical trades. Established almost 50 years ago, National Schools has a rich background of experience to help you to take full advantage of the opportunities in the Radio, Television and Electronics Industry.

**VETERANS**

During the war, National trained enlisted men under contract with the War Department. Both the Armed Forces Institute and Marine Corps Institute used our lesson texts on a wide scale. Now, we are training veterans, both resident and home study, through the Veterans Administration. If you are a veteran of World War II—and qualified for training under the G.I. Bill of Rights, check the coupon below for special information.



**Begin Training at Home  
Later Come to Our Shops and  
Laboratories in Los Angeles**

**—If You Prefer**

National's Master Shop Method Home Training in Radio, Electronics and Television is **COMPLETE** in itself. No other training is necessary; but, some men do prefer to take a short experience course here in our resident shops and laboratories, at the end of their Home Study training. They find it helpful to spend a short period of time in our modern Broadcasting Station, or our New Television Laboratories and Studios, or our Extensive Radio Servicing Shops—as well as other departments covering every specialized phase of the Radio Industry.

You are welcome to take advantage of this additional instruction if you wish. If you are interested, check the coupon below. Full details will be sent you by return mail. National Schools' **OUTSTANDING FACILITIES MAKE IT POSSIBLE TO OFFER THE FINEST POSSIBLE TECHNICAL TRADE TRAINING IN RADIO, TELEVISION AND ELECTRONICS.**

**You Get All This Radio  
Experimental Equipment to  
Use and Keep at Home!**

**LEARN BY DOING** is the basic principle of National's Shop Method Home Training. We send you standard Radio parts for an interesting series of experiments which demonstrate the fundamentals of Radio, Television and Electronics. The very essence of this training is **EXPERIENCE**—you get actual experience by building many different types of circuits. You build a fine, long distance **MODERN SUPER-HETERODYNE RECEIVER**, signal generator, low-power Radio transmitter, audio oscillator, etc. This practical work develops your knowledge of Radio step by step, makes you a practical Radio Technician.

G. I. APPROVED

**NATIONAL SCHOOLS**

LOS ANGELES 37, CALIFORNIA EST. 1905



**MAIL OPPORTUNITY COUPON FOR QUICK ACTION**

NATIONAL SCHOOLS, Dept. 12-RC

4000 South Figueroa Street, Los Angeles 37, California

Mail me **FREE** the two books mentioned in your ad, including a sample lesson of your course. I understand no salesman will call on me. I have checked below the plan which interests me.

NAME . . . . . AGE . . . . .

ADDRESS . . . . .

CITY . . . . . STATE . . . . .

(Include your zone number)

- I am interested in home study only.
- Send information on your Combined Home-Study and Modern Resident Shop Training.
- Veteran of World War II.

# DECEMBER • 1947

Editorial: Should Servicemen Be Licensed? .....by Hugo Gernsback 17  
 Radio-Electronics Monthly Review ..... 18-19  
 Elementary Radio Quiz ..... 83  
 Radio Thirty-Five Years Ago ..... 87

## Electronics

How to Use Radio Propagation Predictions .....by Fred Shunaman 20  
 Radio Piloted Ocean Flight .....by James A. Niland 23

## FM and Television

FM 5 and 7-Tube Tuners .....by Edwin Bohr 24  
 New Tubes Improve FM (Cover Feature) ..... 28  
 FM and Television Design, Part II—Special Circuits and  
 Tuning Equipment Used for Very High Frequencies .....by Milton S. Kiver 32  
 "Super-R" FM Receiver .....by E. E. Shopen 35

## Amateur Radio

Crystal Oscillators—A Few Tests .....by W. E. Anderson, VE3AAZ 29

## Servicing

This Radio Services Itself .....by Roberto Brenta 26

## Radio Set and Service Review—

A Two-Tube FM Converter ..... 30  
 Selling a Radio .....by Jack King 72  
 An Aid to Meter Reading .....by P. Hemardinquer 46

## Sound

Magnetic Recording, Part III—Recorder Design .....by A. C. Shaney 36  
 Interesting Intercommunicator ..... 82

## Test Instruments

A.F. Wattmeter Tests Speakers .....by I. Queen 31  
 High-Range Ohmmeter Has Expanded Scale .....by L. Waltner 34

## Construction

A Modern I-Tuber .....by Harry Winfield 42  
 Making Magnetic Pickups .....by Edwin Cooper 62

## Departments

World-Wide Station List ..... Edited by Elmer R. Fuller 38  
 Transatlantic News .....by Major Ralph W. Hallows 39  
 Try This One ..... 40  
 New Radio-Electronic Devices ..... 44  
 New Radio-Electronic Patents ..... Conducted by I. Queen 52  
 Radio-Electronic Circuits ..... 54  
 The Question Box ..... 56  
 Communications ..... 92  
 Book Reviews ..... 95

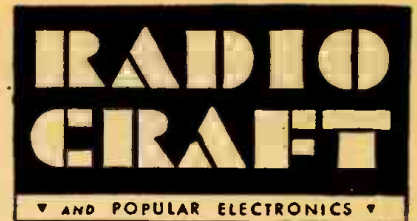

SHORT WAVE CRAFT TELEVISION NEWS  
 RADIO & TELEVISION

**HUGO GERNSBACK**  
*Editor-in-Chief*  
**FRED SHUNAMAN**, *Managing Editor*  
**M. HARVEY GERNSBACK**,  
*Consulting Editor*  
**ROBERT F. SCOTT, W2PWG**,  
*Technical Editor*  
**ANGIE PASCALE**,  
*Production Manager*  
**I. QUEEN, W2OUX**, *Editorial Associate*  
**ELMER FULLER**, *Shortwave Editor*  
**G. ALIQUO**, *Circulation Manager*  
**JOHN J. LAMSON**,  
*Advertising Director*  
**ALFRED STERN**, *Promotion Manager*

## On the Cover:



Manufacture of FM tubes.  
 The young lady is assembling  
 the parts of a 19T8.  
*Chromatone by  
 Alex Schomburg from  
 General Electric photo.*

**LOOK FOR THE JANUARY TV ISSUE!!!**  
 Next month RADIO-CRAFT will publish a special double-size number devoted to the Progress of Television. This number will carry articles by leaders in the industry such as Zworykin and DuMont, articles on television construction and theory, as well as our regular articles on servicing, sound, amateur radio, construction, etc. Reserve your copy today!



Member Audit Bureau of Circulations  
**RADCRAFT PUBLICATIONS, INC.** Hugo Gernsback, President; M. Harvey Gernsback, Vice President; G. Aliquo, Secretary  
 Contents Copyright, 1947, by Radcraft Publications, Inc. Text and illustrations must not be reproduced without permission of Copyright owners.  
**RADCRAFT PUBLICATIONS, INC.** • PUBLICATION OFFICE 29 Worthington Street, Springfield 3, Mass. • EDITORIAL AND ADVERTISING OFFICES 25 West Broadway, New York 7, N. Y. Telephone REctor 2-9690.  
**BRANCH ADVERTISING OFFICES:** Chicago: 308 W. Washington Street, Chicago 6, Ill. Tel. Randolph 7363. Detroit: Frank Holstein, Manager, Room 402 Lexington Bldg., 2970 West Grand Blvd., Detroit, Mich. Los Angeles: Ralph W. Harker, Manager, 606 South Hill St., Los Angeles 14, Calif. Tel. Tucker 1793. San Francisco: Ralph W. Harker, Manager, 582 Market St., San Francisco 4 Calif. Tel. Garfield 2481.  
**RADIO-CRAFT**, December, 1947, Volume XIX, No. 3. Published Monthly on 25th of month preceding date of issue. Allow one month for change of address. When ordering a change, please furnish an address stencil impression from a recent wrapper. All communications about subscriptions should be addressed to the Circulation Manager, Radio-Craft, 25 West Broadway, New York 7, N. Y.  
**SUBSCRIPTION RATES:** United States and possessions, Mexico, Central and South American countries, \$3.50 a year; \$6.00 for two years; \$8.00 for three years. Canada, \$4.00 a year; \$7.00 for two years; \$9.50 for three years. All other foreign countries, \$4.25 a year, \$7.50 for two years; \$10.25 for three years. Entered at Post Office, Springfield, Mass., as second-class matter under the Act of March 3, 1879.  
**FOREIGN AGENTS:** Great Britain: Atlas Publishing and Distributing Co., Ltd., 18 Bride Lane, Fleet St., London E.C.4. Australia: McGill's Agency, 179 Elizabeth Street, Melbourne. France: Brantano's, 37 Avenue de l'Opera, Paris 2e. Holland: Technisch Bureau Van Baarle, Bamelmans & Co., Heemsteedsche Dreef 124, Heemstede. Greece: International Book & News Agency, 17 Amerikis Street, Athens. So. Africa: Central News Agency, Ltd., Cor. Rissik & Commissioner Sts. Johannesburg; 112 Long Street, Capetown; 369 Smith Street, Durban, Natal. Universal Book Agency, 70 Harrison Street, Johannesburg. Middle East: Steimatzky Middle East Agency, Jaffa Road, Jerusalem. India: Susil Gupta (Distributors) Co., Amrita Bazar Patrika Lt., 14 Ananda Chatterjee Lane, Calcutta.

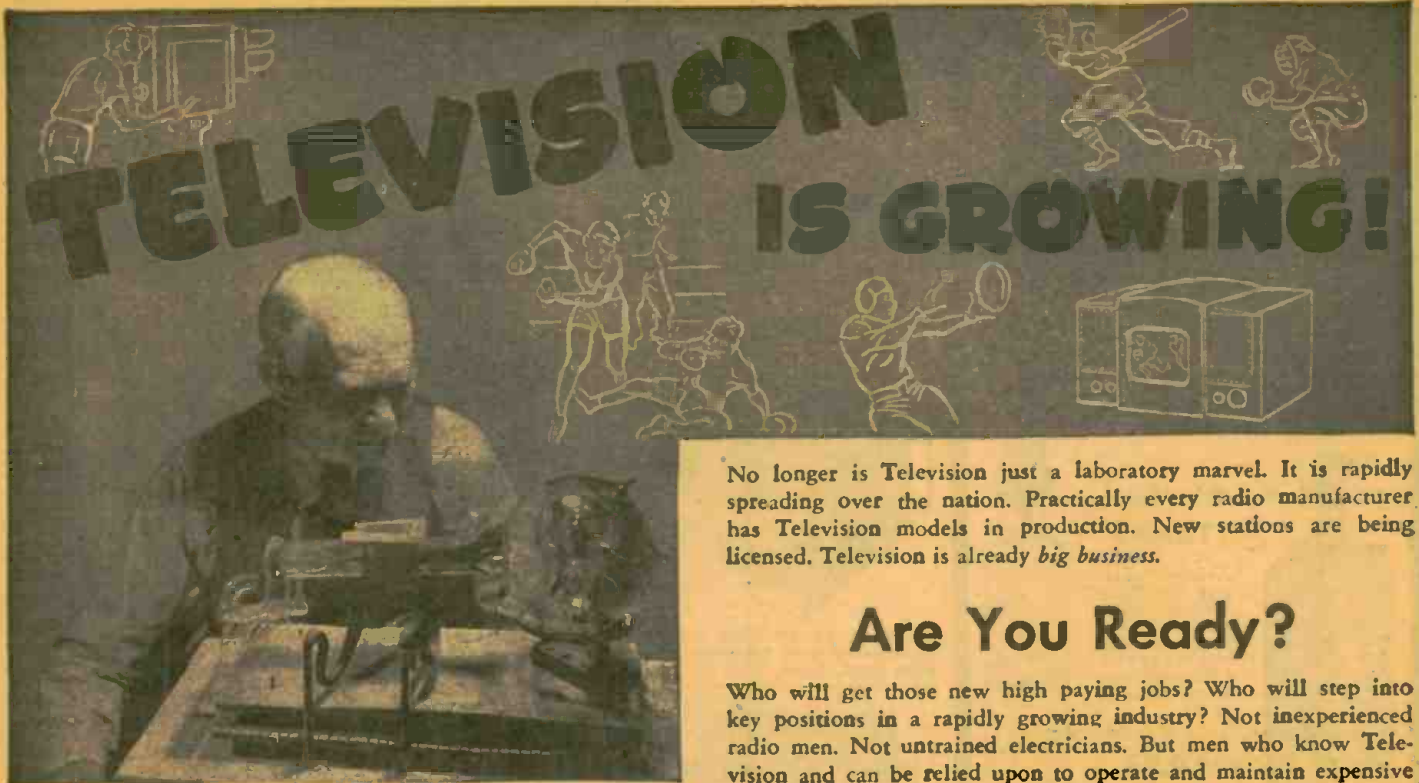

Dr. Lee de Forest

No longer is Television just a laboratory marvel. It is rapidly spreading over the nation. Practically every radio manufacturer has Television models in production. New stations are being licensed. Television is already *big business*.

## Are You Ready?

Who will get those new high paying jobs? Who will step into key positions in a rapidly growing industry? Not inexperienced radio men. Not untrained electricians. But men who know Television and can be relied upon to operate and maintain expensive equipment!

## American Television—A Great Training Institution!

American Television has pioneered in Television research. Its directors have made fundamental contributions to the industry. Dr. Lee de Forest, our Director of Research and Training, is known throughout the civilized world as the "Father of Radio" through his invention of the radio tube. U. A. Sanabria, President and founder of American Television, Inc. invented the Interlace Scanning System which is now the standard of all Television. Most recently, a revolutionary new circuit which corrects a common television defect known as "ghost images" has been developed by J. M. Sanabria, head of American Television's Manufacturing Division.

### Most Elaborate Training Laboratories

Every modern type of equipment obtainable has been installed for instruction purposes in what we believe to be the most extensive and elaborate Television training facilities in the world. You will find complete operating studios with the new sensitive cameras and their associated equipment. A corps of highly qualified instructors will guide your study.



## Start Learning TELEVISION at Home—FREE!

Prepare yourself for the endless opportunities in Television the new "American" way. Now, for the first time, you may discover in advance of entering school, just how your abilities fit into Television. If you qualify under the simple rules, you will be given a complete preliminary home study Television course absolutely free and without obligation.

Your success with the course will not only help you to decide for yourself what phase of Television you like best but will also aid us in qualifying you for residence training.

We prefer that all new resident students take this free course as it provides excellent preparation for residence study. However, there is no obligation on your part to enroll for residence training when you complete the home study course.

We urge you to take advantage of this splendid opportunity at once. Just write your name and address on a penny postcard and say: "I am interested in your free Television Course". Do it today! This offer is necessarily limited.

Approved for Veteran Training

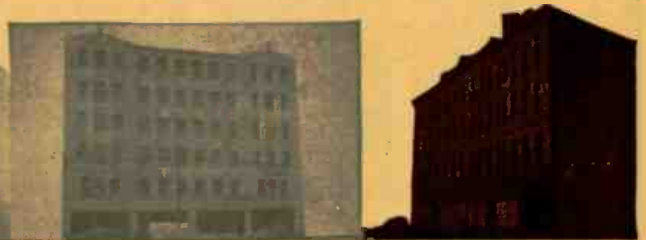

# American Television, Inc.

5050 BROADWAY

CHICAGO 40, ILLINOIS

# ESSE Specials!



## OXYGEN TANKS

Aviators' oxygen breathing bottles. Withstands 500 lbs. pressure. Non-shatterable. Choice of two above types A or B.

**\$6.95**



## BC-1158 TRANSMITTER AND MODULATOR

Made by Bendix for airborne operation. Designed for remote control. Power source 28 V. DC input. (not included). Operates in any place in the 53-60 Mc. and 80-88 Mc. frequency band. Is crystal controlled (crystals not included). Has RF stages, amplifier and driver section, contains 4-815's and 10-12SN7 tubes, 1-0/150 DC milliamp Weston meter which can be switched to various circuits. Has exhaust fan for ventilation. Can easily be converted to operate on several frequency bands. Size 12" x 8" x 18". 45 lbs. Limited quantity .....\$27.50

## INTERPHONE AMPLIFIER

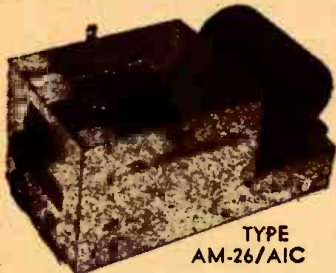

TYPE  
AM-26/AIC

with 28 V. DC dynamotor. Contains 2-12A6 and 2-12J7 tubes. Easily converted for phonograph or inter-communication amplifier \$1.75

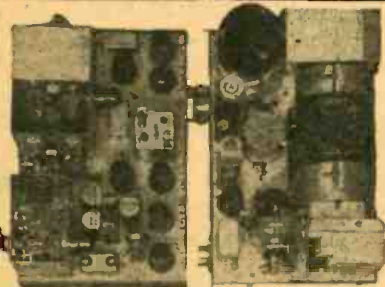

## BC-966-A IFF

Approximately 2 meter frequency operation. 14 tubes, 350V. DC dynamotor, 12 V. DC input. Contains voltage regulators and many other fine parts. Worth more for parts than price asked .....\$4.75

## APQ-13 RECEIVER

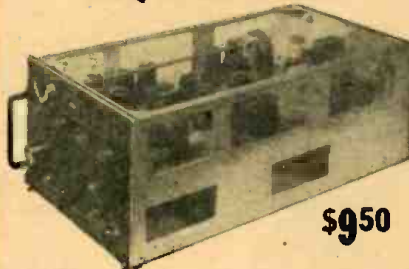

**\$950**

17 tubes, 13 precision resistors, potentiometers, condensers, transformer, knob, switches, pilot light, fuses.



Dynamotor unit MG-1A for SCR-562 transmitter & receiver ..... \$3.75

## DETROLA AIRCRAFT RECEIVER

28 V. DC operated, 200-400 Kc. Good condition.

**\$375**

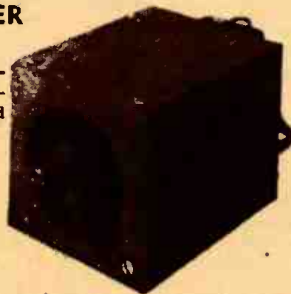

## APN-1 RADIO ALTIMETER



A complete 460 Mc radio receiver and transmitter which can be converted for ham or commercial use. Tubes used and included: 4-12SH7, 3-12SJ7, 2-6H6, 1-VR150, 2-955, 2-9004. Other components such as relays, 24 V. dynamotor, transformers, pots, condensers, etc., make this a buy on which you cannot go wrong. Complete as shown in aluminum case 18" x 7" x 7 1/4" .....\$8.95

All equipment advertised herein is unconditionally guaranteed to the customer's satisfaction to this extent: Return any item advertised within five days after delivery for full refund except transportation charges (both ways).

## BC-357 MARKER BEACON RECEIVER

Ideal for controlling remote circuits for model aircraft, boats, etc. Operates from 75 Mc. Signal easily altered to 2 meter band. Tubes used and included: 12C8 and 128Q7. Also sensitive relay. Circuit diagram included inside case. Size, 5 3/4" x 3 3/4" x 5 3/4" For 24 V. DC operation ..... \$1.95



## IF AMPLIFIER STRIP



19 Mc. contains 5 Western Electric 7-17A tubes ..... \$3.95

## T-39/APQ-9 RADAR TRANSMITTER

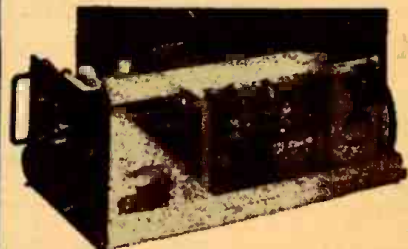

Contains many excellent parts for the VHF experimenter such as a cavity oscillator using 2-RCA 8012 tubes rated at full output to 500 Mc. Tubes are forced air cooled by 24 V. DC motor, which is easily converted for 110 V. AC operation. Other valuable parts such as a pair of 807's, 2-6AC7, 1-931 and 1-6AG7 tubes; ceramic switch, potentiometers, gears, revolution counter, etc. ....\$12.50

## TUBE CHECKER

**\$3750**

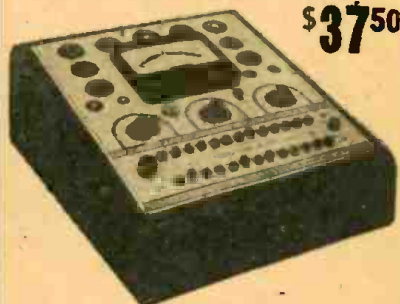

Tube Checker (Universal Instrument Co.) Counter model 501. Tests all tubes in use today. Brand new with manual and factory guaranteed.



(A) Lapp 800 lb. safe working load insulators ..... \$ .95  
(B) Lapp heavy duty insulators with strap mounts ..... 1.65

- A-Condenser, .14 Mfd. 50 V. (metal clad) (New) .....100-\$2.50
- B-Condenser, 16 Mfd. 150 V. (filter condenser) (New) ..... .20
- C-Condenser, .05 Mfd. 400 V. (New) ..... .05
- D-Condenser, .1 Mfd. 400 V. (New) ..... .05
- E-Condenser, .3 Mfd. 50 V. DC (Bathtub) (New) ..... .05
- F-Condenser, 3 x 1 Mfd. 400 V. DC (Bathtub) (New) ..... .05
- G-Condenser (Aerovox), .02 Mfd. 600 V. .... .05

- 
- A-Relay (RBM) 110 V. 60 cy. AC operated DPST (New) ..... \$ .75
  - B-Relay, 110 V. 6 cy. AC plunge type for door interlock (New) ..... .85
  - C-Relay (Clare), 50 V. .0045 amp. 11,300 ohms with 2 micro-switches. (New) ..... .75
  - D-Relay (Leach), type 1253-DEW, 24 V. DC 160 ohms DPST (New) ..... .50
  - E-Relay, 6 meg. 5000 ohm DC resistance SPDT (New) ..... .85
  - F-Relay (Leach), type 1127FR 110 V. 60 cy. DPST (New) ..... .75

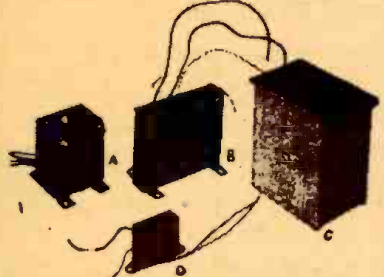
- 
- A-Filament Transformer, 110 V. 60 cy. pri. Sec. 5 V. and 6 V. Center Tapped (cased) (New) ..... .85
  - B-Transformer 110 V.-30 V. (New) Made by Ease for beam motor ..... 4.95
  - C-Power transformer completely cased. 110 V. 60 cy. pri. Sec. has 600 V. CT 105 Ma. Also 5 V. at 3 amp. plus 2.5 V. at 5 amp. and a B.3 winding. (New) ..... 1.85
  - D-Transformer for Selys beam indicators ..... 1.95

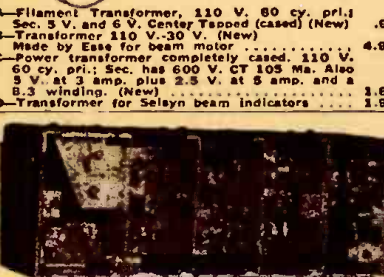
- 
- ARR-1 Receiver, 334-358 Mc. Ideal for mobile receiver or converter on 2 or 6 meter band. Contains 4-954 type acorn tubes, connectors, etc.. \$4.95.

### RECTOX RECTIFIER

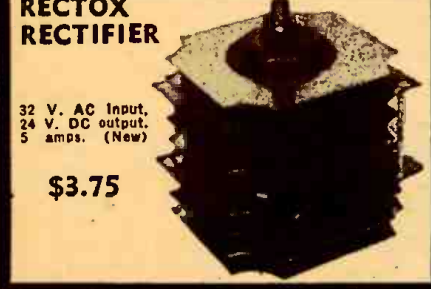

32 V. AC Input,  
24 V. DC output,  
5 amps. (New)

**\$3.75**

- F-Condenser, .25 Mfd. 400 V. (New) ..... .05
- G-Condenser, .125 Mfd. 400 V. (metal cased) dual condenser (New) ..... .05
- H-Condenser, 1.75 Mfd. 50 V. (New) ..... .05
- I-Condenser, .5 Mfd. 600 V. (metal cased) (New) ..... .05
- J-Condenser (GE Pyranol), 2 Mfd. 600 V. (New) ..... .50



IF Transformer, 19.2 Mc. .... .20 ea.

- A-Throat Mikes ..... for \$1.00
- B-Jeweled Pilot Assembly, Candelabra, screw base for 110 V. lamp. Mounts in 1" hole. (New) ..... .25
- C-Telegraph Key J-37 (New) ..... .35
- D-Phone Jacks for PL-85 Plug .07A/C
- E-National V o i v e t Vernier dial drive, 6:2 reduction ratio ..... .75
- F-Ceramic groove coil form, 5" length, 2" diameter, 30 grooves ..... .15
- G-Millie 807 tube shields ..... .25
- H-813 tube shields ..... .35

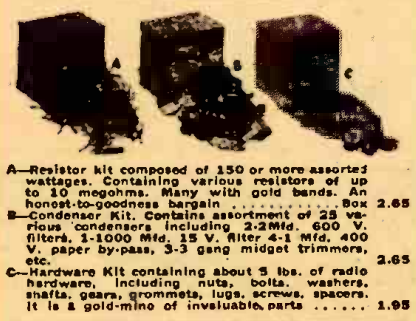
- 
- A-Resistor kit composed of 150 or more assorted wattages. Containing various resistors of up to 10 megohms. Many with gold bands. An honest-to-goodness bargain ..... 2.65
  - B-Condenser Kit. Contains assortment of 25 various condensers including 2.2Mfd. 600 V. filters, 1-1000 Mfd. 15 V. filter, 4-1 Mfd. 400 V. paper by-pass, 3-3 gang midget trimmers, etc. .... 2.65
  - C-Hardware Kit containing about 5 lbs. of radio hardware, including nuts, bolts, washers, shafts, gears, grommets, lugs, screws, spacers. It is a gold-mine of invaluable parts ..... 1.95

- 
- D-Resistor mounting lugs and terminal strip kit. Assorted sizes and shapes. Many. Many 1.00
  - E-Tube Socket Kit, 25 or more assorted sockets having various usable sizes ..... 1.50
  - F-Switch Kit containing assortment of 10 rotary and toggle switches ..... 1.25

- 
- A-Condenser (Solar) 10 Mfd. 1000 V. (New) ..... 2.00
  - B-Condenser (GE Pyranol) 8 Mfd. 1000 V. DC. (New) ..... 1.75
  - C-Condenser (Chl. Ind. Cond. Corp.) 4 Mfd. 2000 V. (New) ..... 2.50
  - D-Condenser (Cornell-Dubilier) 1 Mfd. 4000 V. (New) ..... 3.00
  - E-Condenser (Chl. Ind. Cond. Corp.) Dual 8.5 Mfd. 1000 V. (New) ..... 3.50

- 
- M-Condenser, 2 Mfd. 600 V. (Aerovox) (New) ..... .35
  - L-Condenser, 4 Mfd. 600 V. DC (GE Pyranol) (New) ..... .50
  - K-Condenser, 4 Mfd. 300 V. (New) ..... .35
  - N-Condenser, 30 Mfd. 330 V. AC (GE Pyranol) (New) ..... 3.00

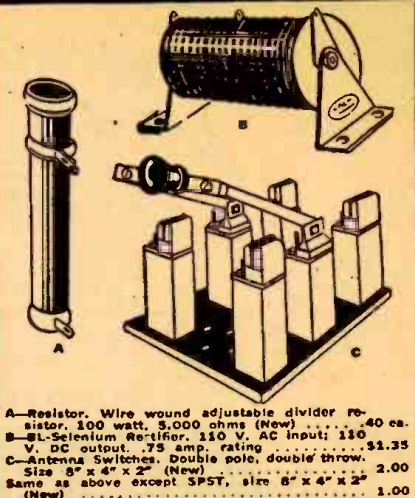

- A-Resistor. Wire wound adjustable divider resistor, 100 watt, 5,000 ohms (New) ..... 40 ea.
- B-Selenium Rectifier, 110 V. AC input; 110 V. DC output, 75 amp. rating ..... \$1.35
- C-Antenna switches. Double pole, double throw. Size 8" x 4" x 2" (New) ..... 2.00

Same as above except SPST, size 8" x 4" x 2" (New) ..... 1.00

### FUSES

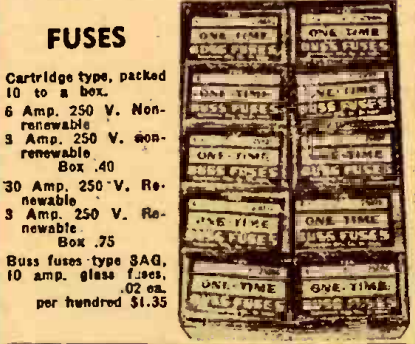

Cartridge type, packed 10 to a box.

- 6 Amp. 250 V. Non-renewable
- 3 Amp. 250 V. non-renewable
- Box 40
- 30 Amp. 250 V. Renewable
- 3 Amp. 250 V. Renewable
- Box 75
- Bus fuses type 8AG, 10 amp. glass fuses, per hundred \$1.35

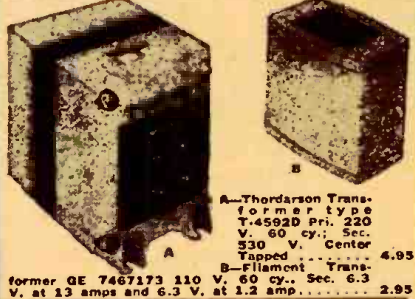

- A-Thoradson Transformer Type T-4592D Pri. 220 V. 60 cy. Sec. 530 V. Center Tapped ..... 4.95
- B-Filament Transformer GE 7467173 110 V. 60 cy. Sec. 6.3 V. at 13 amps and 6.3 V. at 1.2 amp. .... 2.95

### WIRE

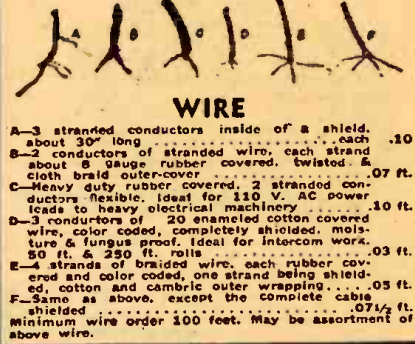

- A-3 stranded conductors inside of a shield, about 30" long ..... each .10
- B-2 conductors of stranded wire, each strand about 8 gauge rubber covered, twisted & cloth braided outer-cover ..... .07 ft.
- C-Heavy duty rubber covered, 2 stranded conductors flexible. Ideal for 110 V. AC power leads to heavy electrical machinery ..... .10 ft.
- D-3 conductors of 20 enameled cotton covered wire, color coded, completely shielded, moisture & fungus proof. Ideal for intercom work. 50 ft. & 250 ft. rolls ..... .03 ft.
- E-4 strands of braided wire, each rubber covered and color coded, one strand being shielded, cotton and cambric outer wrapping, ..... .05 ft.
- F-Same as above, except the complete cable shielded ..... .07 1/2 ft.

Minimum wire order 100 feet. May be assortment of above wire.

ADDRESS DEPT. RC-12



# Radio Co

130 W. New York St.  
Indianapolis 4, Ind.

Unless Otherwise Stated. All of This Equipment Is Sold As Used

**CASH REQUIRED WITH ALL ORDERS**

Orders Shipped F.O.B. Collect

**BIGGEST SAVINGS  
IN HISTORY!**

# RADIO KITS and PARTS

## BUY THE PROGRESSIVE UNIT WAY!

Our prices for radio kits and parts have always been amazingly low. NOW, mass sales have made possible even further drastic reductions through our revolutionary PROGRESSIVE UNIT Plan.

The Progressive Radio Kit, for instance—earlier

reduced from \$19.75 to \$14.75—can now be purchased at a cost of *two kits* for \$28.15 and *three kits* for only \$41.50!

Buy the PROGRESSIVE UNIT way and save \$\$\$\$! See below for our Progressive prices on individual items.

## Progressive AMPLIFIER KIT

This newest Progressive Kit—complete with all parts, tubes and a 12-inch speaker—will enable you to build a newly-designed, high fidelity, humless amplifier for phonograph, AM or FM tuner or microphone.

Regulated power supply maintains constant voltage supply. DC heater supply, whether amplifier is used on

AC or DC, provides humless operation by eliminating cathode-heater leakage hum. Contains degenerative feedback for improved frequency response, balanced phase inverter and push-pull beam power output. Every stage thoroughly decoupled to improve low-frequency response and prevent motor-boating. Tone control completely varia-

ble. Six-tube performance. Uses 1-6R105, 1-12SL7, 2-50L6's and two selenium rectifiers.

### PROGRESSIVE UNIT PRICES ON AMPLIFIER KIT

1 kit	\$25.75
2 kits	49.50
3 kits	69.00

# NOW BUILD 15 RADIOS

**COMPLETE  
KIT  
\$14.75**



**ABSOLUTELY NO KNOWLEDGE OF RADIO NECESSARY  
YOU NEED NO ADDITIONAL PARTS**

THE PROGRESSIVE RADIO KIT is the ONLY COMPLETE KIT. Contains everything you need. Instruction Book, Metal Chassis, Tubes, Condensers, Resistors and all radio parts. The 36-page book written by expert radio instructors teaches you to build radios in a professional manner. You start with one-tube receivers, then build two-tube receivers, then three-tube receivers. (The three-tube receivers are equal to four-tube receivers because of the addition of a selenium rectifier.) You then construct a powerful public address system which will

permit you to address large audiences. Then you make three different transmitters so you can get a real thrill out of being on the air. Before you are done with this kit, you will have built 11 receivers, 1 Public Address System and 3 transmitters.

### SPECIAL FREE OFFER

Electrical and Radio Tester sent absolutely FREE with each Progressive Radio Kit. PLUS FREE membership in Progressive Radio Club. Entitles you to free expert advice and consultation service with licensed radio technicians. Write for further information or ORDER your KIT NOW!

### PROGRESSIVE UNIT PRICES ON RADIO KIT

1 Kit	\$14.75
2 Kits	28.15
3 Kits	41.25

## RADIO PARTS SCOOP!

**NO SURPLUS—ALL PARTS GUARANTEED BRAND NEW!**



### PHONES—Single Head Set

1000 Ohms, DC. Reg. Price \$1.65  
Buy 1 for \$1.10 and save 55c  
Buy 2 for \$1.90 and save \$1.20  
Buy 3 for \$2.65 and save \$2.40

### CONDENSER KIT

50 paper tubular condensers, values from .002 mfd. to .1 mfd., 400 vdc to 800 vdc. Regular Price \$5.00  
Buy 1 kit for \$1.95 and save \$3.05  
Buy 2 kits for \$3.80 and save \$8.20  
Buy 3 kits for \$5.65 and save \$9.45

### RESISTOR KIT

100 carbon resistors, 1/2 watt, RMA color coded, values from 330 ohms to 2.2 megohms. Regular Price \$5.00  
Buy 1 kit for \$1.50 and save \$3.50  
Buy 2 kits for \$2.80 and save \$7.20  
Buy 3 kits for \$3.90 and save \$11.10

### SELENIUM RECTIFIERS

Regular price \$1.10  
Buy 1 for 79c and save 31c  
Buy 2 for \$1.54 and save 66c  
Buy 3 for \$2.25 and save \$1.05



### 12" ALNICO SLUG SPEAKER

Regular Price \$8.00  
Buy 1 for \$5.60 and save \$2.40  
Buy 2 for \$10.80 and save \$5.20  
Buy 3 for \$15.95 and save \$8.05  
(No more than 3 to a customer)

### ELECTROLYTIC CONDENSERS

20-20 mfd. 150 W.V.DC. Regular Price 75c  
Buy 1 for 30c and save 45c  
Buy 4 for \$1.16 and save \$1.84  
Buy 7 for \$1.96 and save \$3.28  
Buy 10 for \$2.65 and save \$4.85  
40-40 mfd. 150 W.V.DC. Regular Price \$1.05  
Buy 1 for 45c and save 60c  
Buy 2 for \$2.80 and save \$4.55  
Buy 10 for \$3.80 and save \$6.70  
10-10 mfd. 450 W.V.DC. Regular Price \$1.25  
Buy 1 for 65c and save 60c  
Buy 2 for \$1.24 and save \$1.28  
Buy 3 for \$1.74 and save \$2.01

### ANTENNA AND RF COIL SET

(broadcast Band) Reg. Price \$1.00  
Buy 1 set for 59c and save 41c  
Buy 2 sets for \$1.10 and save 90c  
Buy 4 sets for \$2.08 and save \$1.92

### VARIABLE CONDENSER

(420-420 mfd.) Regular Price \$1.80  
Buy 1 for \$1.45 and save 35c  
Buy 2 for \$2.60 and save \$1.00  
Buy 3 for \$3.60 and save \$1.80



### Famous Make SOLDERING IRON

55 watts 110/120 volts. Regular price \$2.50  
Buy 1 for \$1.90 and save 60c  
Buy 2 for \$3.60 and save \$1.40  
Buy 3 for \$5.10 and save \$2.40

Radioman's Combination LONG NOSE PLIERS and CUTTERS of exceptional quality. Hydrized for extra toughness. Diamond-tested cutters. Regular price \$1.95  
Buy 1 for \$1.45 and save \$ .50  
Buy 2 for \$2.70 and save \$1.20  
Buy 3 for \$3.60 and save \$2.25

### PROGRESSIVE RADIO TOOL KIT

A Progressive Electronics Special. Contains 55 watt 110/120 volt soldering iron, radioman's combination long nose pliers and cutters, amber handle screw driver, alignment tool. Regular price \$4.95

Buy 1 kit for \$3.25 and save \$1.70  
Buy 2 kits for \$6.10 and save \$3.80  
Buy 3 kits for \$8.70 and save \$6.15  
(No more than 3 kits to a customer)

## MAIL COUPON TODAY

PROGRESSIVE ELECTRONICS Co., DEPT. RC-8  
22 Havemeyer St., Brooklyn 11, New York

SIRS: Please send me the following .....

Enclosed find check or money order (postage prepaid) for \$..... Send C.O.D. (I will pay postage). Send additional information on radio kit.

NAME .....

ADDRESS .....

CITY ..... ZONE ..... STATE .....



# How do you stack up in the modern radio servicing field?



- AM BROADCAST RECEIVERS
- FM BROADCAST RECEIVERS
- TELEVISION RECEIVERS
- AUTOMATIC PHONOGRAPHS
- HOME RECORDING DEVICES
- PUBLIC ADDRESS SYSTEMS
- INTERCOMMUNICATING SYSTEMS
- HEARING AIDS
- TELEPHOTO EQUIPMENT
- HOME FACSIMILE RECEIVERS
- RADIO WEATHER DEVICES
- HOME SOUND MOVIES
- RADIO TELETYPEWRITERS
- ALARM SYSTEMS
- CARDIOGRAPHS
- CHEMICAL CONTROLS
- CIRCUIT BREAKERS

- SAFETY DEVICES
- SELECTING MACHINES
- SIGNALLING
- SIGN CONTROLS
- DENSITY MEASURING DEVICES
- DETECTORS
- DETONATORS
- DOOR OPENERS
- DRYERS
- ENGINE TESTERS
- ELEVATOR LEVELERS

- ELECTRIC FENCES
- FURNACE CONTROL
- FURNACES, INDUCTION
- GAS DETECTION
- GRADERS
- HEATERS
- MEASURING DEVICES
- METAL ANALYSIS
- MICROSCOPES
- MOTOR CONTROLS
- PACKAGING

- MOBILE COMMUNICATIONS EQUIPMENT FOR:
  - POLICE, FIRE, FOREST SERVICE, AIRCRAFT, MARINE, EXPLORATIONS, RAILROADS, TAXICABS, STREETCARS, BUSES, TRUCKS, AMBULANCES, EMERGENCY VEHICLES, ETC.
  - SYNCHRONIZERS
  - THERAPY EQUIPMENT
  - THICKNESS GAUGES
  - TIMERS
  - TRAFFIC CONTROLS
  - VIBRATION
  - WEIGHING
  - WELDING
  - WRAPPING
  - X-RAY

**CREI Technical Training Can Prepare You  
Now to Meet These New Demands That Mean  
More Money and Security for You!**

Have you taken a really good look recently at the expanding service field? Do you have a feeling of helplessness when you think of some of the intricate, new-model equipment that you may be called upon to service? Or of the many jobs you may be missing in these related fields because you feel you don't know anything about them?

You may as well face the facts. You must keep your technical ability in pace with industrial developments—or be left behind because you lack understanding of radio-electronics as applied today to business and industry.

There is no need to tell these things you already know. But it is important for you to realize that, no matter whether you are a "beginner" or an "old timer", CREI home study training can help you. You will find that CREI courses in Radio-Electronics and Television are pitched to your own level. They take you *all the way* from introductory basic principles to advanced training, on to specialized subjects. CREI training can help you *right now*, in your daily work in the installation and servicing of radio-electronic equipment.

CREI's reputation has been proved over a period of 20 years. Join the many servicemen who are studying—at home—the new developments and techniques with CREI—protecting their future jobs, their businesses by acquiring the new "know-how" NOW!

Find out for yourself how CREI can help you to greater security and prosperity. See and read an actual lesson. Get the feel of how easy and interesting it is to improve your ability with CREI. Send in the coupon now!

**VETERANS! CREI TRAINING AVAILABLE UNDER THE "G. I." BILL!**

**Capitol Radio Engineering Institute**  
*An Accredited Technical Institute*

DEPT. RC-12, 16TH AND PARK ROAD, N. W., WASHINGTON 10, D. C.  
Branch Offices: New York (7): 170 Broadway • San Francisco (2): 760 Market St.

RADIO-CRAFT for DECEMBER, 1947

## SEND FOR ONE OF THESE FREE LESSONS!

Now, see for yourself! Read one of these interesting lessons from the CREI course. You will see, in advance, how practical it is to improve your ability the CREI way.

*From Practical Radio-Electronics Course:*  
"ELECTRON PHYSICS AND ELECTROM THEORY"—Discusses modern theories of the composition of matter, including atomic energy, and their relation to present-day radio-electronics.

*From Practical Television Course:*  
"PICK-UP TUBES—ICONOSCOPE AND IMAGE DISSECTOR TUBES"—Discusses fundamental pick-up tubes of the television camera. It precedes the study of the Orthicon and the Image Orthicon.

**MAIL COUPON FOR FREE  
24-PG. BOOKLET & SAMPLE LESSON**



CAPITOL RADIO ENGINEERING INSTITUTE  
16th & Park Rd., N.W. Dept. RC-12, Washington 10, D. C.  
Mail me ONE FREE sample lesson and your 24-page booklet, "CREI Training for Your Better Job in Radio Electronics". I am attaching a brief resume of my radio experience, education and present position.  
Check One  PRACTICAL RADIO-ELECTRONICS Course:  PRACTICAL TELEVISION

NAME .....

STREET .....

CITY ..... ZONE ..... STATE .....

I am entitled to training under the "G. I." Bill.

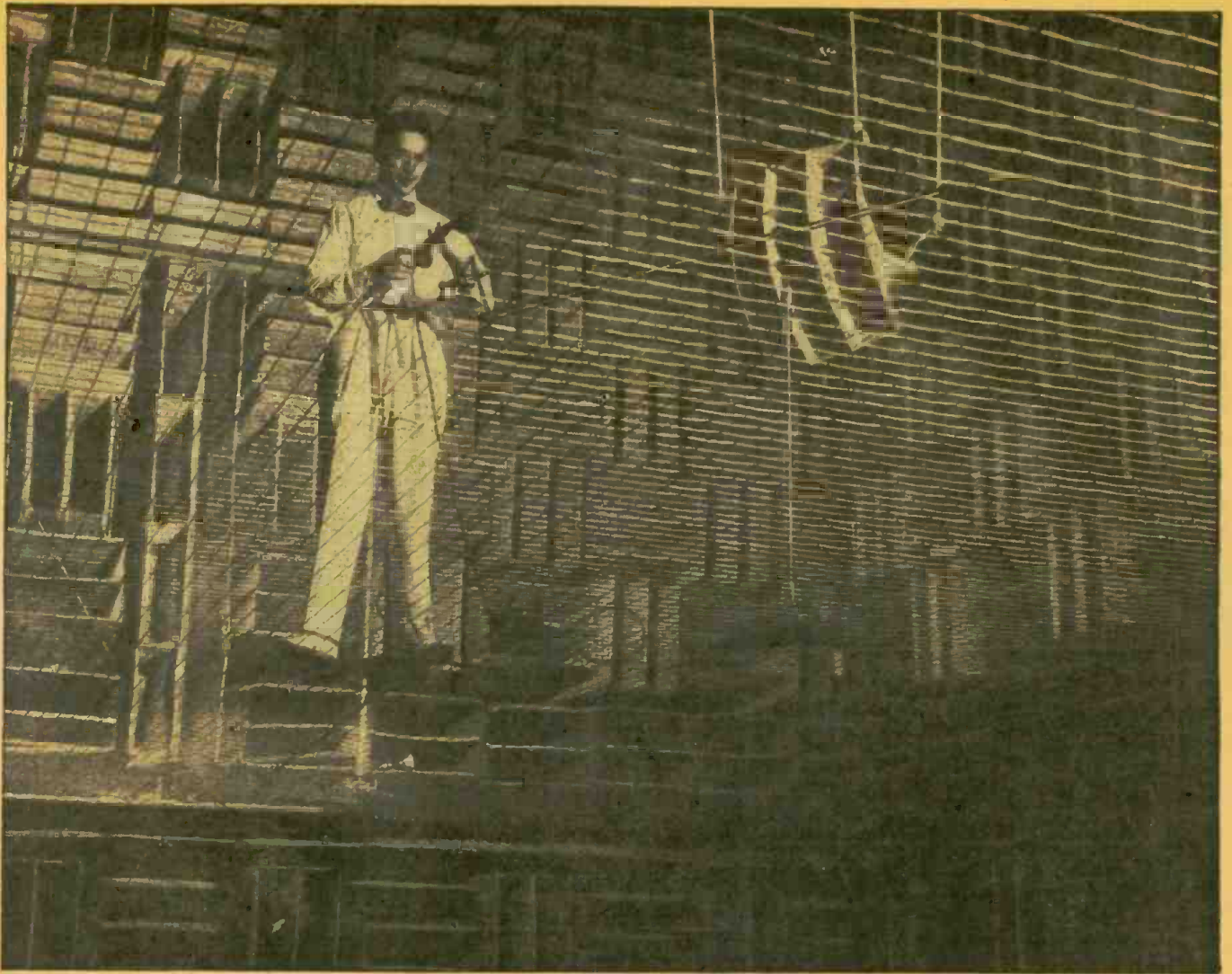

A telephone listens to a loud speaker in the new "free field" acoustic test room at Bell Telephone Laboratories. The sound-transparent "floor" is built of steel cables.

## Test-tube for Sound

This giant "test-tube" is actually an echoless sound room at Bell Telephone Laboratories. Here engineers seek new facts about sound which will help them make telephone service still better and more dependable.

Bell scientists know a great deal about what happens to sound in electrical systems. This new room will give them a powerful tool to find out more about what happens to sound in the air.

In an ordinary living room, most of the sound addressed to you comes by way of reflections. At 10 feet less than 10% reaches you directly.

Sound that bounces at you from walls, ceilings, furniture, and your body is all right for hearing—but it poses questions for scientists who would study it uncontaminated by reflections.

The Bell Laboratories "test-tube" gives telephone people the chance to produce pure sound and analyze it reliably with respect to intensity, pitch, and direction. The entire room is lined with glass wool, contained in wire-mesh cases, wedge-shaped to give maximum absorbing area. Sound bounces along the sloping surfaces, sifts into the soft glass wool, and is gradually stifled.

This is one more example of Bell Laboratories' constant work to learn more about everything which can extend and improve telephone service.

### BELL TELEPHONE LABORATORIES

Exploring and inventing, devising and perfecting for continued improvements and economies in telephone service.



# Should Servicemen Be Licensed?

*Service-Licensing, or Self-Policing — Which Will It Be?*

—By Hugo Gernsback

**R**ADIO-CRAFT has pointed out for many years that sooner or later, either national, state, or local licensing of radio servicemen would have to be viewed realistically by servicemen.

In past years much pressure has been put on by various authorities to license servicemen for a variety of reasons. Chief among these reasons are:

1. Danger to radio owners (such as electric shocks) from errors of diagnosis and repair of radio sets.
2. Fire hazard due to faulty repairing.
3. Abuses of many kinds by servicemen in their repair work.

These are the main and perhaps overall reasons. There are others.\*

Last October the New York City Administration through its City Councilman Stanley M. Isaacs called for mandatory licensing of all radio technicians and radio repairmen in New York City. The Board of Directors of the *Radio Manufacturers Association* immediately adopted a unanimous resolution opposing this proposed licensing of radio servicemen.

The *Radio Manufacturers* made it clear that it does not deny that abuses exist in the radio servicing and repair field, abuses which the licensing regulations might correct. These, according to the Association, involve "exorbitant" fees and poor workmanship. The RMA points out that only a small minority of the radio servicing trade are guilty of such abuses. But the industry feels, according to spokesmen, that "bureaucratic regulation" is not the final answer to the subject. The resolution also stressed that there was no intention of criticising the New York Municipal Administration in any way. It is rather the implications of general licensing that are feared.

The Association rightly feels that if New York sets a precedent in licensing radio servicemen, it is almost certain that other cities throughout the country will soon enact similar measures. The Association is convinced that it would be far better that the servicing industry police itself to do away with present abuses. The Board also pointed out that such initial steps for self-policing are now being taken. As an example, they call attention to a forthcoming experimental clinic for radio repairmen in Philadelphia.

RADIO-CRAFT has pointed out many times in the past that the servicemen themselves can do a great deal to ward off unfavorable legislation and licensing if they would themselves form either a national servicing league, or as this seems to be difficult to achieve at present, that servicemen in all cities should certainly have local Associations to do the policing.

It is true that a few such associations exist in some

cities, but there are far too few of them and they cannot be said to exist on a nation-wide scale. It would seem that unless such a nation-wide movement soon gets under way, either stringent federal or state legislation will result. This is certain to prove a great handicap to the servicing industry. Usually when such controls are applied, the individual serviceman particularly, loses much of his freedom. Other new factors will also be injected which in many ways are bound to handicap him. We all know that most of the servicing abuses are perpetrated by a small minority of irresponsible individuals, but it is precisely this minority who give the servicing industry its bad name. It is unfortunate that human nature is such that satisfactory work is seldom praised to the skies, but let one serious abuse come along and instantly the entire servicing industry is blamed.

The country would be best served at the present time by the establishment of local associations. These would issue to each member a shield for display in his place of business, stating that he is a member of the association and licensed by it under a serial number. The local association would make it its business to ascertain that all representative servicemen are properly enrolled. Then by running educational advertisements in the local newspapers the public would quickly learn to patronize only "association men".

It would then be a simple matter to trace those servicemen who abuse the trade, and sufficient pressure could be brought by the association on such non-members to make it almost impossible for the minority, wild-cat servicemen to make a living.

None of this is new. It has been proposed in various ways before, but the unfortunate part is that so far little or nothing has been done about it. There are already certain areas in this country where servicemen are even now subject to restrictive measures, as for instance Madison, Wisconsin, which has an ordinance for "licensing radio and electronic servicemen". Special legislation on the subject has been drafted in Baltimore, Los Angeles, Orlando, Fla., although as far as has been ascertained none has been enacted into law.

It has often been said, and rightly so, that many people feel that licensing is a threat to the freedom of enterprise and freedom for the individual service man. Indeed, many believe this to be so. But we might also point out that numerous other services are licensed such as plumbers, electricians, and scores of others. They do not appear to be very much down-trodden.

It is quite true that licensing always imposes certain restrictions on the licensee, yet in many trades licenses are distinctly necessary and often essential to the welfare of the community.

RADIO-CRAFT does, however, believe that at the present  
(Continued on page 78)

\*See also article "Licensing Problems and the Serviceman" by H. W. Schendel, November, 1945, issue RADIO-CRAFT.

# RADIO-ELECTRONICS



"Train of the Future" dining car. Speaker is near stairs to "Astra-Dome." Left—the antenna on top of observation car.



**RADIO AND RAILROADS** are at last getting together. Proof is in the design of "The Train of the Future" revolutionary new General Motors exhibit now touring the country on the principal railroads.

The train has loudspeakers in all cars and in the *Astra-Domes*, a special feature of the new trains. *Astra-Domes* are "upstairs" sections of the car, raised above the standard roof and enclosed in heavy shatterproof glass. The loudspeakers are connected with radio, recording, and PA apparatus for reproduction of radio programs, wire recordings, or direct voice.

"The Train of the Future" has a complete intercar telephone system, linking all cars and the locomotive. At present it is proposed that use of this system be limited to the crew, but there is no reason why its service should not be extended, if it is found expedient, to permit passengers to call the diner or the sleeping-car porter, for instance.

A second telephone circuit permits connection by means of plug-in lines while the train is standing at a station. When the train is in motion, passengers may still talk to their friends in any part of the world provided with regular line telephones, with automobiles or other trains equipped with mobile radio,

(Continued on page 79)

**A MODEL "RADIO TUBE"** made of rubber, with "electrons" in the form of bronze balls tests electronic designs in a single day that would require 3 months otherwise, Westinghouse revealed last month. The new model, it is stated, is helping to develop new tubes for television and high-frequency radio.



The experimental model "vacuum tube" in use. The model looks something like a game table.

It consists of a very thin sheet of rubber stretched across a frame about the size of a small dining room table. BB-shot-sized bronze balls simulate electrons; hills and valleys in the rubber simulate electrical voltage; and wooden blocks act as tube elements.

Proper arrangement of the hills and valleys direct a ball and control its velocity. Measuring the time it takes for the ball to roll from one part of the table to another, enables engineers to calculate the speed of actual electrons in a tube. This determines the electrical voltage needed for that part of the tube.

To find the proper spacing and optimum shape of tube elements wooden reproductions of various shapes and sizes of cathodes, grids or anodes are used. They help research men to find the arrangement that gives the best focusing of electrons.

The model, which can produce approximate replicas of most kinds of tubes, permits checking the internal design of a tube in one day compared to three months by the old mathematical trial and error method.

**MAX PLANCK**, world-famous physicist and originator of the quantum theory, died October 3, at the age of 89.

Planck is regarded as one of the great scientists of the present generation and one of the scientific immortals of all time. His quantum theory has contributed to the advance of science in the same measure as Newton's discovery of the laws of gravitation or Copernicus' theory of the solar system.

He made his fundamental discovery that radiant energy is not continuous, but comes in small bundles, whose energy content varies with the frequency of the radiation, in 1900. In his own words "Radiant heat is not a continuous flow and indefinitely divisible. . . . It must be defined as a discontinuous mass, made up of units all of which are similar to one another."

These quanta, which he referred to as "the pennies of the atomic world," are so small as to be unobservable in studies of large-scale phenomena, but are of great importance in the study of atomic phenomena, and especially of the physics of the atomic nucleus.

**FM STATIONS** are losing money. is the consensus of a survey reported last month by the FM Association. Profits were reported by only 8% and 6% said they were breaking even, while 86% were operating at a loss.

Prospects for the future appear to be good, with 25% reporting increasing business and practically all the rest at least holding their own.

# MONTHLY REVIEW

**AN "ATOMIC PILE"** in model form has been built by General Electric engineers to demonstrate the principles of atomic energy production, reports from that company stated last month.

The model is not full scale, and is quite schematic. At the left is the atomic "pile" where matter is transformed into

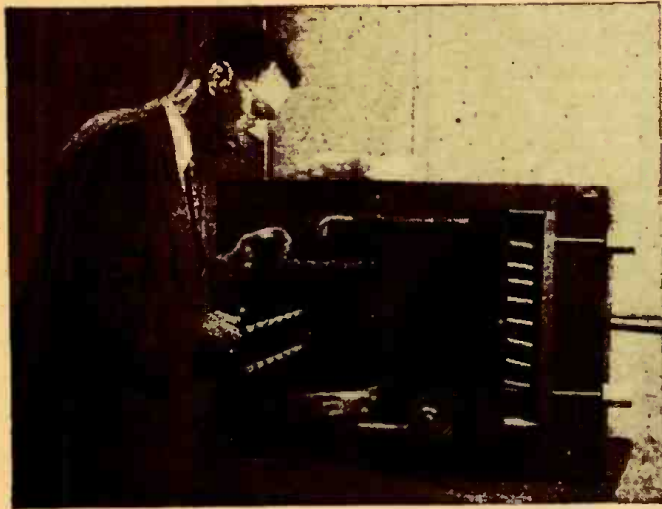

energy by the splitting of uranium or another fissionable element. In his left hand Dr. Kenneth H. Kingdon, one of the first physicists to isolate Uranium 235 from the natural element, holds a rod of this "fuel" material, while the striped rods projecting horizontally represent the control rods which would prevent the process from running away. A heat-exchanging fluid would be pumped through the pile, thence to the heat exchanger on the right, where water would be turned to steam. This would then be used to drive turbines in the customary way.

The heat exchanger step is needed because anything entering the pile would become dangerously radioactive, and thus steam could not be brought directly from it.

**MOST POWERFUL RADIO** broadcast station in the world will shortly be erected at Geneva, Switzerland, by the United Nations, it was reported on good authority to RADIO-CRAFT last month. The power will be 1,000 kilowatts.

This station will operate on 250 kc (1200 meters) and has been designed to blanket all of Europe. Located strategically in Switzerland, it is certain to reach practically every radio receiver on that continent. Europe has a very large number of crystal receivers. These normally cannot receive signals farther than from 25 to 50 miles. It is expected that every crystal set in Europe will be able to receive the new U. N. broadcast station signals.

**DIAMONDS** are more useful as detectors of certain types of atomic radiation than the standard Geiger-Muller counter, the National Bureau of Standards revealed last month.

To use a diamond as a counter, it is clamped between two small brass electrodes maintained at a difference in potential of about 1000 volts. When a source of gamma radiation is brought within range of the diamond, pulses of current occur across the electrodes, which after amplification may be detected and counted on any suitable indicating device, such as an oscilloscope, a current meter, a set of headphones, or a loudspeaker. In apparatus assembled at the Bureau, primary amplification is effected with original intensity through the use of a triode very close to the diamond in

*(Continued on page 89).*

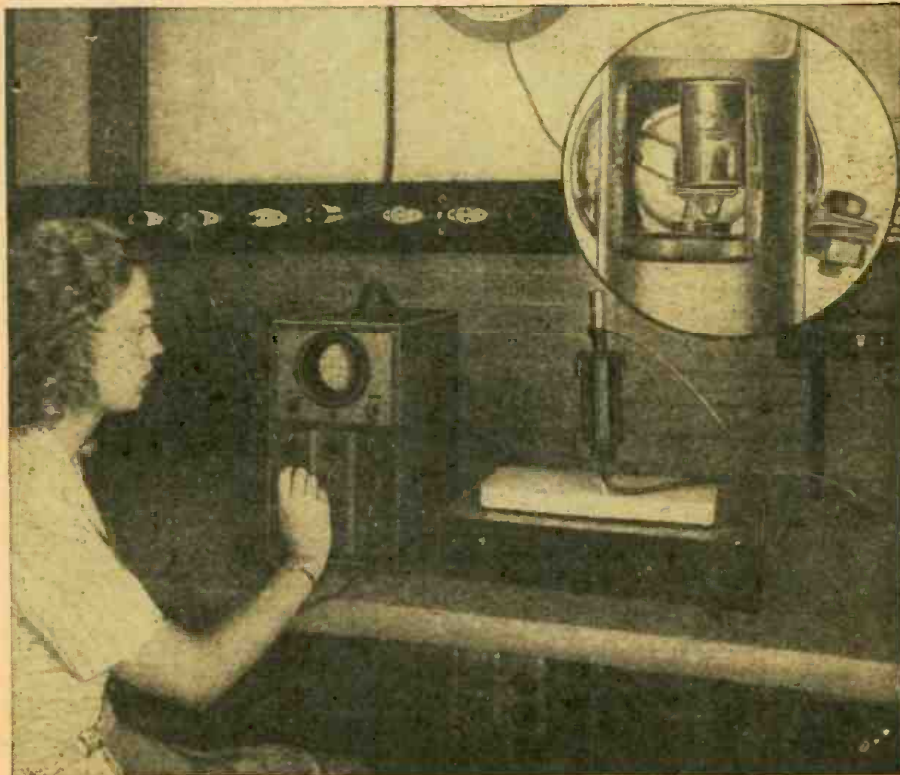

The diamond radiation counter in use. Enlarged insert shows diamond between its electrodes.

**HEARING AIDS** can be made universally applicable, instead of being individually prescribed, Dr. S. Smith Stevens of the Harvard Psycho-Acoustic Laboratories affirmed last month. A tentative set of specifications for the universal hearing aid includes:

1. Even frequency response, with no sharp peaks or valleys. Lower cut-off should be between 200 and 400 cycles and upper cut-off between 3,000 and 4,000 cycles.

2. Steadily rising characteristic of 3-4 decibels per octave throughout the range.

3. Limit to maximum acoustic output.

4. Sufficient sensitivity and freedom from internal noise to render intelligible to a normal ear speech delivered to the instrument at a level not more than 10 db above the threshold of intelligibility of the same ear.

5. Acoustic gain sufficient for the user. Individuals vary so widely that possibly 3 models with different amounts of gain may have to be designed.

6. Effective volume control with range of at least 40 db.

7. Stability and freedom from squeals and oscillation at maximum gain setting.

**MAJOR GENERAL INGLES**, wartime head of the Signal Corps, was elected president of RCA Communications, Inc. at a directors' meeting held early this fall. General Ingles is also a director of RCA Communications and of the Radio Corporation of America. Major General George L. Van Deusen, who during the war was chief of the Engineering and Technical Service of the Office of the Chief Signal Officer at Washington, D. C., succeeds General Ingles as President of RCA Institutes.

# How to Use

# RADIO PROPAGATION PREDICTIONS

By FRED SHUNAMAN

**O**LD-TIMERS remember when the best radio wave was the longest one. The long wave was *reliable*. It maintained the same strength day and night at all times of the year, and the strength dropped off steadily with increasing distance from the transmitter. Short waves—roughly those under 1000 meters—were “unreliable.” They varied in strength with the time of day and the season and

showed other “unpredictable” vagaries.

The reliability of the long waves was obtained at the cost of high power. With the coming of broadcasting, it was found that a station of a few hundred watts could be heard (when conditions were good, such as on a cold winter night) farther than a long-wave station of many kilowatts. Then the amateurs started to work at even higher frequencies, first on 150 meters (2 mc),

then 80 (3.5 mc), later 40 and 20 (7 and 14 mc). At each increase of frequency they were able to transmit farther with less power.

But other and more disquieting discoveries were made. A station which pounded in with ear-splitting volume one night might simply not be there at all the next. Amateurs found they were not able to communicate with old friends in the next state, but were being received solid several thousand miles away. Thus was “skip distance” discovered. One point was clear: if some way could be found to figure out these high frequencies, a new era in low-power, long-distance communication would open up. Scientists, amateurs, and communications companies set out to learn more about these mysterious waves.

First, the scientists Kenelly and Heaviside suggested that the upper parts of the atmosphere were *ionized*—that the ultraviolet rays of the sun break up the atoms in these upper regions where the air is so thin as to resemble a poorly exhausted vacuum tube—into negative electrons and positive

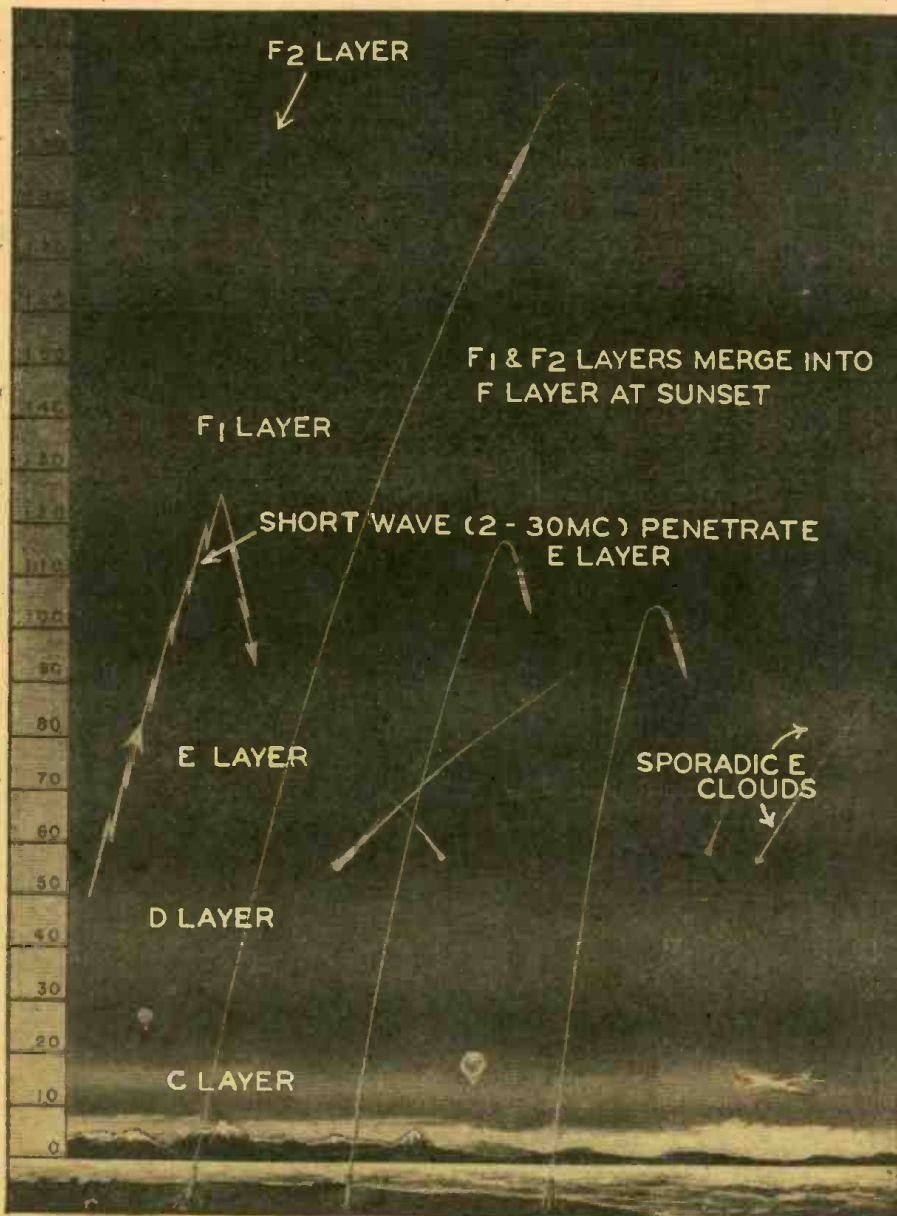

The various layers of the atmosphere. Though all affect radio transmission at certain frequencies, F-layer reflections are most important for long-distance communication. Scale at left in miles.

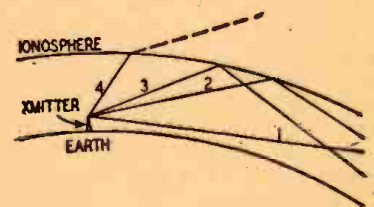

Fig. 1—Long waves follow path 1, shorter ones, 2 or 3, and very short waves, path 4.

ions. These upper regions of the atmosphere, they said, were filled with a partly conductive material, something like the interior of a gas-filled vacuum tube. This ionized layer reflected radio waves of high frequencies back to earth, but lower-frequency waves were merely absorbed by it. The higher the frequency, the farther the waves penetrated the layer; thus the greater the distance at which the reflected wave reached the earth (Fig. 1). Above a certain *critical frequency*, the waves keep right on through the layer and are lost to earth entirely.

In 1923 the English scientist Appleton proved the existence of the Kenelly-Heaviside layer by beaming radio waves straight up and measuring the time the reflected waves took to return. He found that the higher-frequency waves took longer to come back, proving that higher frequencies penetrate farther into the layer.

Height of the layer as measured by this earliest radar was about 70 miles. But as frequencies were raised toward 3 mc, the echoes suddenly disappeared—to return from a distance of more than 150 miles. Obviously there were two reflecting layers. Above 8 mc a double echo was noted, as if the higher layer were split in two.

The lower layer is now called the E-layer, and the higher one—or two—the F1- and F2-layers. The F2-layer is the most important one to long-distance, high-frequency communication. The E-layer is more important in daylight and at frequencies below 4 mc, though at times its effects may be felt up to 20 mc. Below these layers are the C- and D-layers, whose effects on radio waves have been little studied, but which are beginning to be considered important at certain frequencies.

The Bureau of Standards at Washington has been one of the leading explorers of the ionosphere, and began in the late '30's to issue rough predictions of the probable ranges at various frequencies. The predictions were very approximate, and covered only four periods—summer and winter noon and midnight.

The demand for reliable radio communication during World War II made much more detailed and accurate knowledge of ionosphere conditions necessary. Numerous stations were established at widely scattered points, and continuous records were made and transmitted to Washington for interpretation and correlation with those from other stations. These stations now number 58, and gather ionospheric data from all parts of the earth. The Central Radio Propagation Laboratory (CRPL) of the Bureau of Standards uses this information to issue monthly predictions of usable radio frequencies. These are put out in the form of monthly booklets, 3 months in advance. They contain maps and charts showing the maximum usable frequency for communication between any 2 points on the earth's surface at any time of day. The booklets are entitled *Basic Radio Propagation Predictions* and are used in connection with another publication, *Instructions for the Use of Basic Radio Propagation Predictions* (Bureau of Standards Circular 465), which contains further maps, charts, nomographs, and instructions for use with the *Predictions*.

The *Predictions* consist of a series of charts of the ionosphere. Fig. 2 is one of them. The maps show the maximum usable frequencies (muf) for points at 4000 kilometers away from any point on the earth at any given time of day. Points on the same latitude do not have the same ionospheric conditions at the same time of day throughout the world. Therefore it is necessary to have 3 sets of charts. The western (W) chart includes South America, all the United States but the northwestern tip, most of Canada, the Atlantic Ocean and a bit of Africa. The eastern (E) chart is applicable to Asia and Australia, and the intermediate (I) to Europe, Africa, northwest Canada, Alaska, and a belt of the Pacific.

### Predictions not easy to apply

The *Predictions* are not particularly easy to use. It is often necessary to use 2 charts in conjunction, checking them against a third when the E-layer may affect results. A further difficulty is that radio waves follow great-circle paths, while the charts are square Mercator projections. This difficulty is solved with a great-circle chart in the *Instructions*. To use the *Predictions*, put a piece of tracing paper over the map of the world in the *Instructions* (Fig. 3). Mark the

points between which communication is to be established. Also trace the equator line on the tracing paper. Then place the tracing paper on the great-circle chart (Fig. 4) with the equator lines coinciding, and slide it back and forth until one of the curved lines on this chart connects the 2 points. Draw the great-circle path between them along that line. Put the tracing paper on the correct ionosphere chart with the local station on the vertical line marking the local time of desired communication.

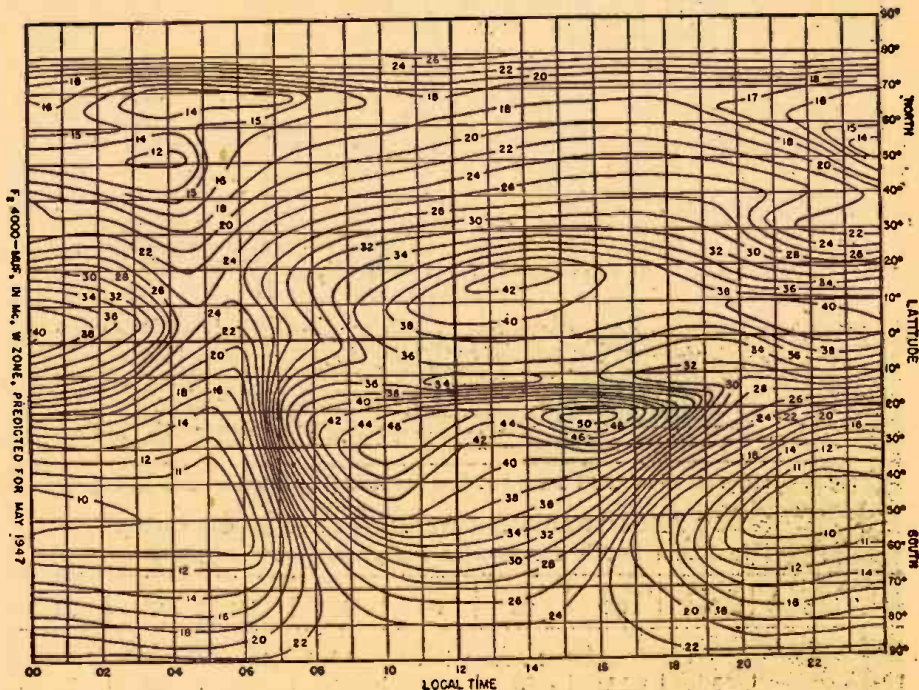

Fig. 2—One of the ionosphere charts. There are six of these F2 and one E-layer chart.

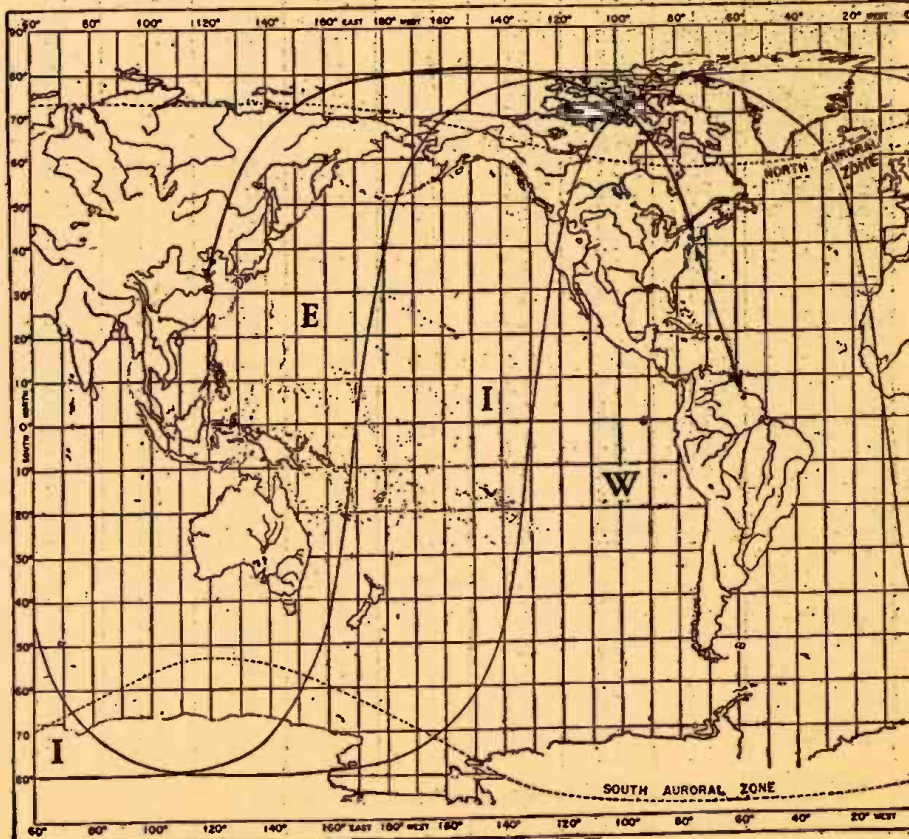

Fig. 3—Part of the world map, showing the two great-circle paths mentioned in the text.

Finding the correct frequency now depends on whether the distance is more or less than 4000 km (2500 miles).

If the distance is exactly 4000 miles, the problem may be relatively simple.

The mid-point of the great-circle path is located and the maximum usable frequency (muf) read direct from the F2 4000 chart for the given zone. For example, suppose contact is to be made

between New York and Georgetown, British Guiana, a distance of approximately 4000 km. The tracing paper is placed over the world map and the 2 points, as well as the equator, are marked on it. Then the paper is placed over the great-circle chart and moved back and forth till a great circle joins the 2 points. The path between the two is drawn, as well as the *mid-point* of that path.

The tracing paper is then placed over the F2, 4000 W map with the equator lines again coinciding and the New York point on the hour meridian of the time desired. The muf of the *mid-point* is read. For example, in December 1947, the muf of the mid-point of the great-circle path between New York and Georgetown is 21 mc for 6 am, 34 mc for 12 noon, and 21 mc for 6 p.m.

Since unpredictable conditions may cause the predictions to be in error, a frequency 15% lower than the muf is taken as the *optimum working frequency* (owf). Thus all muf's are multiplied by 0.85 for actual working frequency.

If the distance is greater than 4000 km, 2 points 2000 km from each end of the path are taken instead of the mid-point. The tracing paper is placed over the map as before and both points, as well as the equator, marked. The meridian of Greenwich may be drawn also, as a time reference. It is usually easier to use it for great distances than the local time of either of the 2 stations at the ends of the path. The great-circle chart is again used to find the actual radio path between the 2 points. Instead of marking the mid-point of the path, control points 2000 km from the ends of the path are marked. (Experience has shown that muf's at great distances are little different than at 4000 km.) The maximum usable frequency for each of these points is found (on the appropriate chart) and the lower of the two taken as the muf for the entire path.

For example, communication between New York and Shanghai is desired. Drawing the path and control points, the muf's for the New York control point are found to be 28, 12, and 12 mc for 0600, 1200, and 1800 GMT, respectively. At the Shanghai end, using the F2 4000 E chart (not shown) all 3 muf's are found to be 12 mc. The muf for the whole distance is then 12 mc for the given times, and the owf 10.2 mc.

For distances less than 4000 km a little more work must be done. The muf is first found exactly as for the 4000 km. Then the muf of the mid-point is found on the F2 0 chart, which shows the critical frequencies for waves projected directly up from the sending station. Since the distance is between 0 and 4000 km, it might be expected that its muf would be between these two. And so it is, but in a way that does not vary directly with distance. A nomograph is provided in the *Instructions* for distances less than 4000 km. A straightedge is placed between the muf at 0 and that at 4000 km, and the correct frequency is read where the straightedge intersects the line representing the dis-

(Continued on page 86)

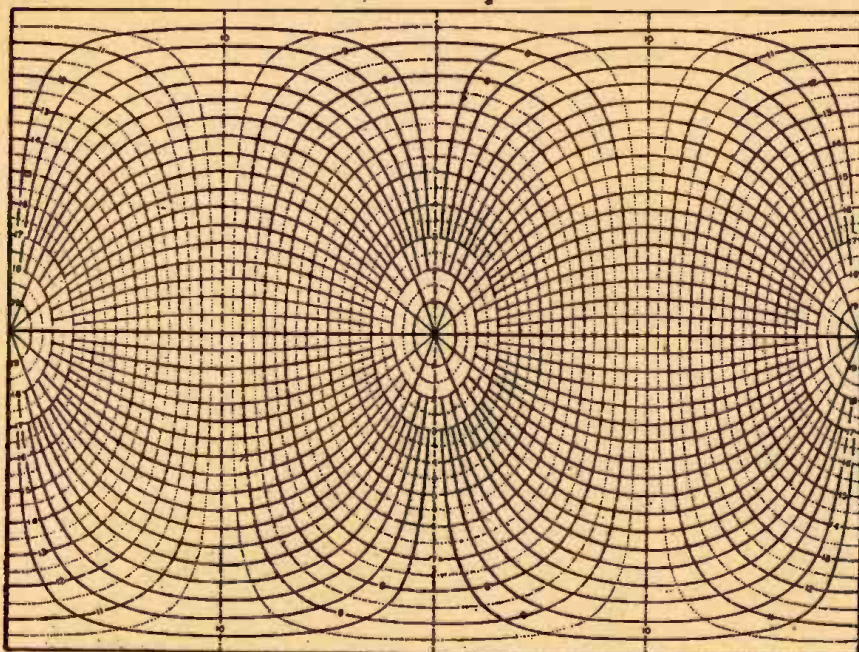

Fig. 4—This great circle chart is used to find the radio transmission paths on Fig. 3.

**RADIO PROPAGATION CHART — DECEMBER 1947**  
(Maximum usable frequencies are given in megacycles)

Time	00	03	06	09	12	15	18	21
			2,500 miles		4,000 km			
N	12	11	13	20	35	34	20	13
NE	11	11	12	32	40	34	19	11
E	14	13	24	43	40	36	24	15
SE	11	12	24	34	35	29	18	13
S	12	12	14	36	34	30	24	16
SW	12	12	11	32	35	32	25	16
W	15	14	13	22	41	40	36	24
NW	11	11	11	13	37	39	33	18
N								
			5,000 miles		8,000 km			
N	12	11	13	16	16	16	16	13
NE	10	11	12	32	32	10	10	9
E	9	13	24	48	38	24	18	12
SE	11	12	24	34	35	29	18	13
S	12	12	14	36	34	38	24	16
SW	12	12	11	32	35	32	25	16
W	15	14	12	8	38	40	36	24
NW	11	10	10	9	10	26	33	18
			7,500 miles		12,000 km			
N	12	11	13	12	12	12	12	13
NE	11	11	12	27	16	10	11	11
E	14	13	24	29	30	28	24	15
SE	11	12	24	33	32	29	18	13
S	12	12	14	24	26	26	24	16
SW	12	12	11	25	28	32	25	16
W	15	14	13	22	26	30	26	24
NW	11	11	11	10	11	16	33	18
			10,000 miles		16,000 km			
N	12	11	13	20	33	20	20	13
NE	11	11	12	31	28	26	19	1
E	14	13	24	35	30	32	27	15
SE	11	12	18	19	22	22	18	13
S	12	12	14	16	16	16	16	16
SW	12	12	11	18	18	19	19	16
W	15	14	13	22	26	30	31	24
NW	11	11	11	13	22	18	33	18
			12,500 miles		20,000 km			
M.u.f.	14	14	24	30	30	26	26	18
Direction	E	W	E	NE	NE	NW	NW	NW



# RADIO PILOTED OCEAN FLIGHT

By JAMES A. NILAND\*

**A** BIG four engined U. S. Air Force C-54 was rolled out of the hangar at Stephenville, Newfoundland. Fourteen men, called an emergency crew, climbed aboard. Once inside, the pilot, Colonel James M. Gillespie, started the engines, taxied the plane to the runway and pointed it into take-off position. Stepping away from the controls, he pushed a button. The button was marked "Brise Norton."

Ten hours and fifteen minutes later the wheels of the plane touched down on the landing strip at Brise Norton, England. *Not once during the 2,400-mile flight across the Atlantic did any member of the emergency crew touch the controls.* The trip was entirely a radio-controlled automatic flight. Eighteen days later the robot Skymaster returned in the same manner when Gillespie pushed a button marked "Stephenville."

As easy as push-button radio tuning, automatic flight is now a reality. Accomplished by an electronic brain that stores information given to it before the flight begins, the brain reads the flight instruments, listens to the radio signals, measures distances and air speed and carries out for the pilot and his crew all the functions necessary to conduct a point-to-point flight from one airfield to another.

The original idea for automatic flight cannot be credited to any one individual, but to a group of Air Force officers. Chief amongst them were Colonel Ben S. Kelsey and Captain Harry S. Brudlove. It was not Colonel Kelsey's original intention to provide pilotless flight. He rather intended to provide methods for accomplishing many routine functions of monitoring the complete flight and making decisions concerning navigation and changes in flight plan.

As the project developed, it was found that more and more pilot duties could be made automatic, until finally they had eliminated almost entirely the need for a pilot.

The devices which control the All-Weather C-54 are not standard. Most of them have been specially constructed for their specific purpose and only one automatic unit of this type exists. It has been popularly misconstrued as a drone plane operated by a mother plane.

(Continued on page 74)

\*Project Officer, New York Field Office  
United States Air Forces

The Sequence Selector is the brain of the robot plane.

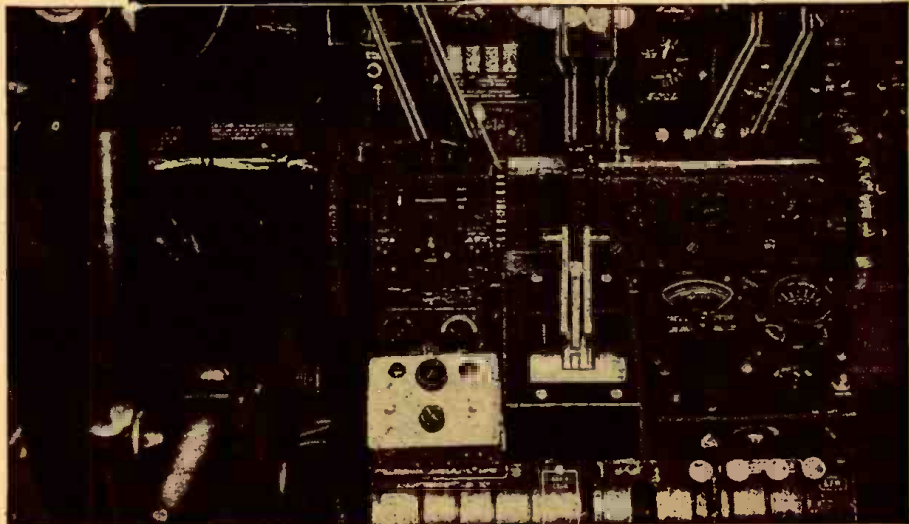
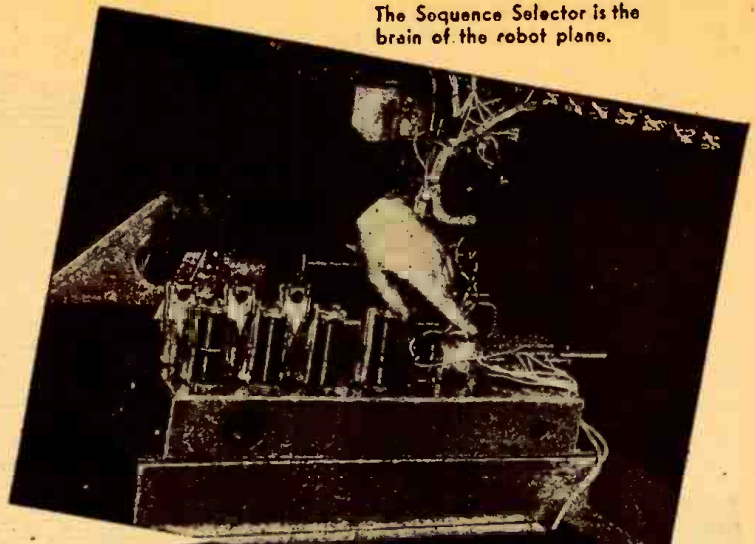

Center—The Automatic Flight Controller (rear) with Capt. Roman J. Whiting, navigator; Capt. Thomas J. Wells, test pilot; and Mr. James L. Anast, chief of the automatic flight branch at Clinton County Air Field. Bottom—Cockpit of the automatically-controlled C-54 plane.



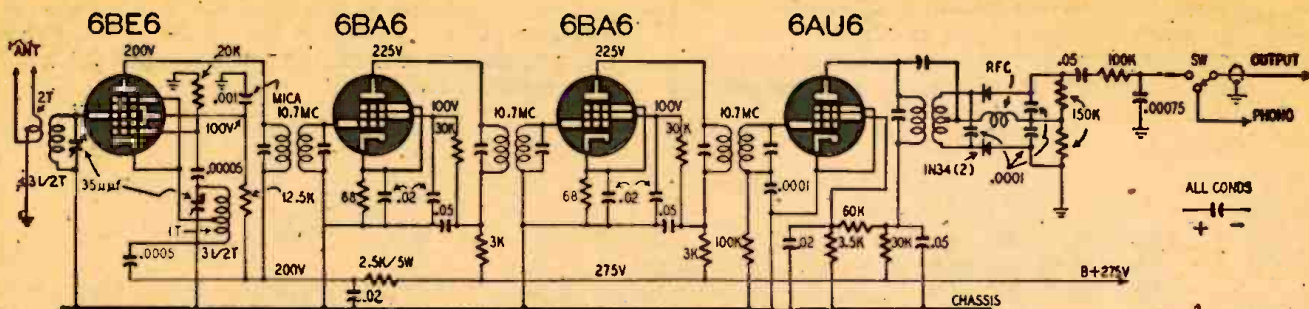

Fig. 2—This can be either a 5-tube tuner with a 6AL5 detector, or may be hooked up as a 4-tuber with the germanium crystal detector.

of the stages falls as the carrier frequency deviates from the frequency to which the i.f. is tuned. This produces amplitude modulation.

### The circuit

Since the objective was to get best possible results, the set was a rather ambitious one, containing an r.f. stage, 2 i.f.'s, and 2 limiters. (See Fig. 1.) The constructor who requires a simpler tuner may construct a set along the lines of Fig. 2, which will cut his number of tubes to 4, though the circuits are those of a 5-tube tuner. Two i.f.'s are found advisable, and eliminating one of them to save another tube would not be a good idea unless the constructor lives close to the stations he expects to receive. One of the photographs shows a receiver built with the circuit of Fig. 2, with the addition of an r.f. stage and the use of a 6AL5 detector instead of the germanium crystals.

Since the features of the small tuner follow in-general those of the larger one, the latter will be described in complete detail. Seven tubes are contained in the tuner circuit, Fig. 1. First are a 6AG5 r.f. amplifier, 6AG5 mixer, 6J8 oscillator. (These 3 tubes comprise the radio-frequency section and are mounted upon an upright chassis affixed directly to the tuning condenser to secure short grid leads.) A 6AC7 first i.f., 7G7 second i.f., and two 7C7's as limiters are employed in the intermediate stages.

The 6AC7 is still one of the highest-gain tubes in the tube manual, and its gain is put to good use in the first stage. Because of the 6AC7's high gain, it is necessary to pay careful attention to decoupling and other precautionary measures. Two of Sylvania's 1N34 germanium diodes are used in the discriminator. (A 1N35 balanced pair would of course be better.) Besides being convenient to wire in the circuit, these diodes have the added advantages of long life and no filament current requirements. The r.f. assembly is mounted upon its separate chassis secured to the tuning condenser. It obtains its power from a plug which connects to a power socket on the chassis. The output from the 6AG5 mixer is fed through a short length of co-axial cable to a low-loss microphone connector also on the chassis located near the first i.f. transformer. With this type of construction the entire tuning unit may be removed without disturbing the remainder of the radio.

Cathode injection was originally used in the mixer stage, but this was rejected later because tuning of the mixer coil had too great an effect upon oscillator tuning. Inductive coupling was used also between the r.f. stage and mixer originally. However, the present system is much more successful. From the diagram it will be noted that one half of a 6J6 is used for the oscillator. The 6J6 was found necessary because a 6C4 would not oscillate strongly enough with the available 105 volts unless the cathode was tapped very far up the oscillator coil, which made for unstable operation. The 105 volts for the r.f. section preferably should be regulated with an OC3/VR-105 to prevent frequency shift with changes in line

voltage. Unless it is regulated, detuning due to the turning on of an electric heater or similar appliance will cause the signal to be severely distorted, necessitating retuning to the station.

The r.f. coils are ½ inch in diameter  
(Continued on page 81)

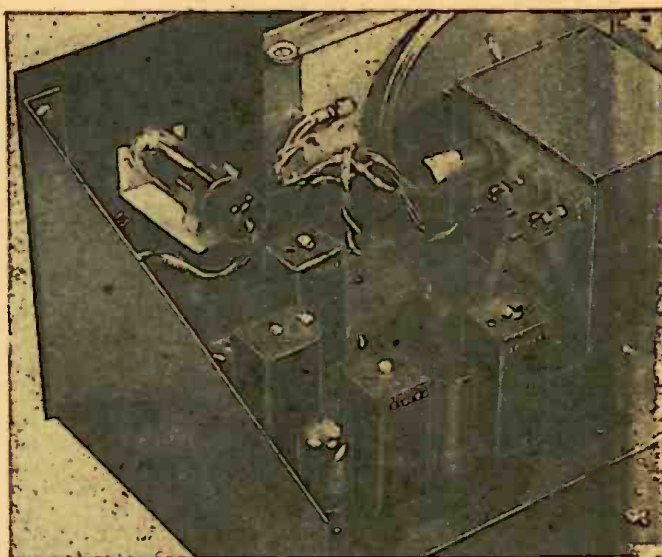

Above is the "FM corner" of the author's large FM-AM receiver.

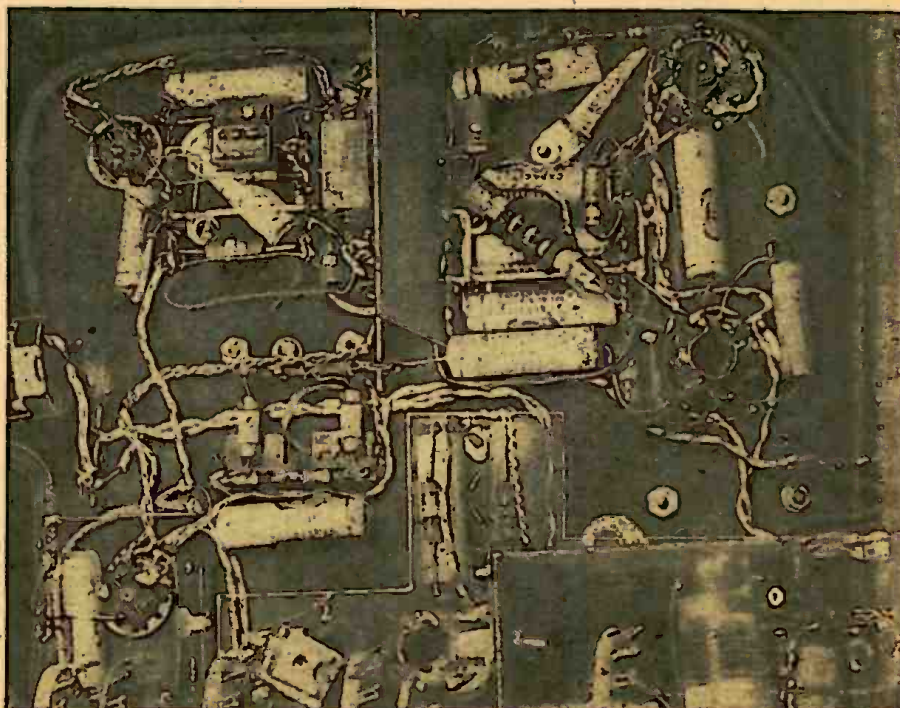

Under-chassis view of the FM area. The partly blanked out section is part of the AM section.

Here is an authoritative article on the much-discussed Cosmo Compo radio, written by the man who invented it. This receiver, which is already being sold in metropolitan department stores, has been hailed by some non-technical writers as a means of emancipating the radio owner from the repairman. Read what the inventor, himself a former radio serviceman, has to say on that subject.

# This Radio Services Itself

By ROBERTO BRENTA

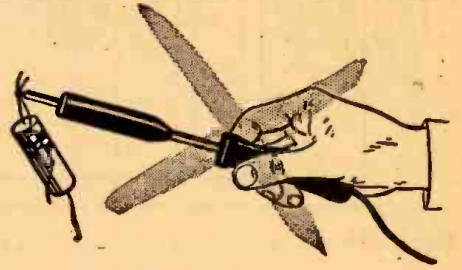

These Compo cans may be changed in a fraction of a minute, curing any trouble due to the enclosed component. As one of the cans contains the complete audio-circuit and another all the filter components, it is obvious that a radio can be repaired in a few minutes. The drawing at left is the artist's conception of the contents of one (which one?) of the Compo cans above.

spent in repair exceeds the price of the original estimate.

## A serviceman's dream

This among other things prompted me to try to find a suitable answer to the problem. During my years studying engineering in the Navy as a radio technician, I had little time to work on the idea. We worked night and day building and repairing radios of all types. Sometimes we had plenty of tools and materials—at others we lacked almost all the proper parts and replacements. Most serious of all, we were understaffed because of the lack of trained technicians. When a component was unobtainable we either had to improvise or scrap an entire unit or set.

I began to think again about my old plan to simplify radio receivers. Seeing all the waste proved to me that the time was ripe for a radio that would eliminate the complexities of hundreds of parts and wires and reduce the repairman's problems by expediting the work.

When the war in Europe ended I was stationed in Guam in the Pacific. With the cessation of hostilities in the West our job lessened daily. I began to get a few hours for myself each day and used the time for experiments. I wanted to find a way to reduce unnecessary waste. I wanted to find a way to utilize the cast-off parts and units that were deteriorating from lack of use. It struck me that if I took several parts, or better still, a complete circuit and tied the parts together in a single replaceable unit, I would have the answer I was looking for. From the beginning I toyed with the idea of segregating into sections a conventional 5-tube circuit.

The first experimental set gave me quite a bit of trouble because of the long grid leads. This was eliminated by re-arranging the socket positions. I realized then that with further engineering effort such a radio was a practical possibility.

Another big problem was the size of the filters, resistors and condensers. It was impossible to squeeze those components into a unit of practical size. I

**B**EFORE anyone can honestly call himself a radio repairman he must have a thorough knowledge of radio electronics. He must be familiar with all types of radio receivers. He must have the proper tools and equipment to give proper service.

For many years many complex problems have faced the radio repairman from the time he puts a radio receiver on his bench till he returns it to its owner in playing condition. It is not uncommon for him to find himself on the short end of a deal. When all the time, energy and materials that go into the

repairing of a radio are considered, there is always the chance that he will not make any profit and may lose money. That may sound strange to the layman, but is recognized by the repairman as an everyday possibility. For example, the customer doesn't realize that the breakdown that occurs several days after his set has been fixed has absolutely nothing to do with the original trouble. He insists that the repairman did a poor job and is responsible for putting the set right without further cost. In some cases the cost of additional parts that are needed plus the added time

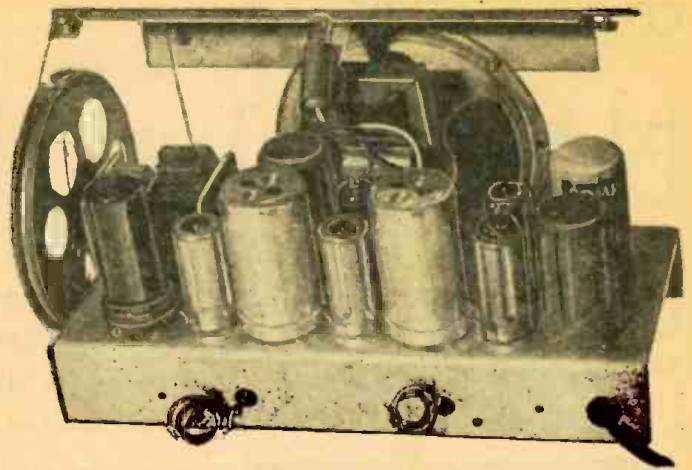
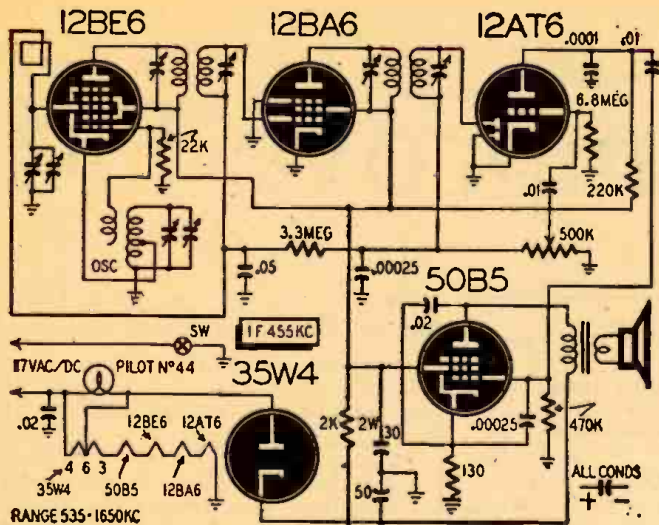

Left—Schematic is standard, though mechanical features are novel. Above—Rear view of the plug-in receiver illustrated below.

then considered the use of miniature components, which was the answer to the problem of reducing the size to fit the containers.

There was always something to slow up my progress. After solving the difficulties of putting r.f. components into cans, I ran into trouble with audio quality. This was solved by special attention to matching the output transformer, output tube and speaker, and by using a 50B5 output tube.

### The Compo receiver

In brief, I have succeeded in developing a compact AM receiver in which all the elements of a superhet circuit have been made plug-in. Oscillator and i.f. units are pretuned and there is sufficient tolerance to make interchangeability of units quite practical. All the normal under-chassis resistors and capacitors are included in their respective cans, leaving nothing underneath but the filament wiring. Volume control will be plug-in eventually.

The present model consists of 5 vacuum tubes: 12BE6, 12AT6, 50B5, 35W4. In addition, there are 6 component tubes which are color-coded and numbered. The oscillator section includes a specially designed oscillator coil with the coupling from the coil to the grid and the grid resistor. The first and second intermediate frequency transformers are in two separate cans or containers. Also in these containers are the automatic volume control line and first audio grid input. Then there is the power supply consisting of a filter and filter resistor.

Included in the Compo cans are the following parts: Oscillator is in a green can numbered 114; the 1st i.f. is in a blue can numbered 115; the second i.f. is in a black can numbered 116; the a.v.c. is housed in a yellow can numbered 117; the audio output is in a brown can numbered 118; the filter is in a red can numbered 119. There is also a 35W4 rectifier, 12BE6 converter mixer, 12BA6 i.f. amplifier, 50B5 power output and a 12AT6 detector and 1st audio.

A test has been going on in the laboratory since June 9th. A Compo receiver has been in operation 24 hours a

day without interruption under normal operating conditions. So far, the set has been working perfectly and without any signs of difficulty.

### A plug-in amplifier

Using the same principles, a 40-watt experimental amplifier has also been developed. In this case, I have worked out the amplifier so that all the condensers and resistors are wired on a plug-in fibre panel. If anything goes wrong all that has to be done is to remove the entire unit and replace it with a completely new working part. The part that has gone bad can then be repaired and used as a spare.

The Compo system could well be extended to include not only receivers and public address systems, but to cover many types of electronic devices. It would be particularly valuable in commercial and industrial equipment where the time lost in repairing a piece of equipment is more valuable than the

price of the parts. A stock of replacement units might in such cases save costly delays, or even the cost of complete standby equipment.

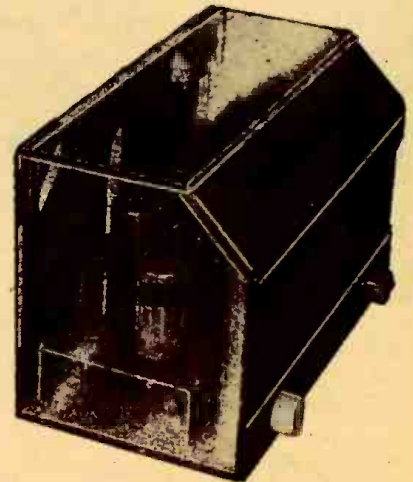

This is a glass-enclosed demonstration model.

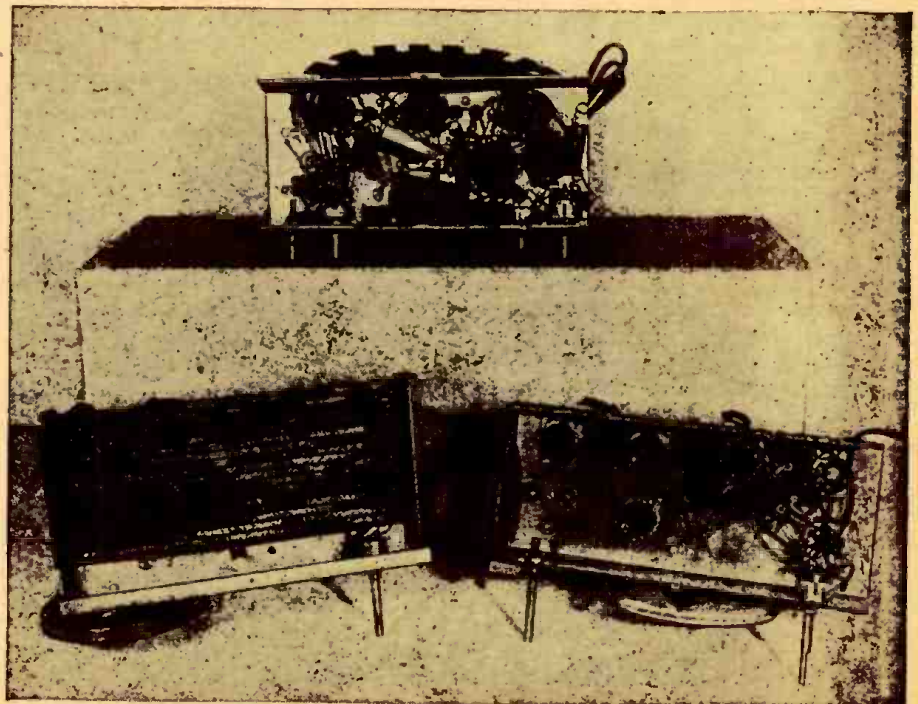

Top—An old-style set with its maze of under-chassis wiring and dangling components. Lower right—Present Compo receiver. Lower left—Stamped-wiring Compo receiver of the future.

# New Tubes Improve FM

**S**UCCESSFUL circuits for FM depend on tubes which work well at frequencies near 100 mc. Among the new tubes designed to improve FM reception are the 19T8, assembly of which is illustrated on our cover

**The 19T8 and similar tubes are designed for high frequencies.**

the 6T8. Designed for use as a combined AM and FM detector and audio-fre-



An assembly operation on the new FM tubes.

this month. Its 6.3-volt counterpart, the 6T8, and the 12AT7 are other tubes especially designed for FM, and were announced at the same time by the General Electric Co.

The new tube consists of 3 sections, one of which contains a triode, while the other two have 2 diodes and 1 diode respectively. Shields around the diodes are identical in appearance with the triode plate, giving the appearance of a triple-triode tube.

Operating skill in assembling tubes takes on new importance with the increasing complexity of these multielement, high-frequency units. The size of the tube is decreased though the number of elements in it is increased. The person whose skillful fingers put together the various parts of the tube becomes an important factor in FM progress. Economical production demands that these complex tubes be constructed to rigid specifications with a minimum of rejected tubes.

The 19T8 is identical to the 6T8 tube except for the difference in filament voltage, which is 18.9 at 0.15 amp in the 19T8 and 6.3 volts at 0.45 amp in

**TABLE I**

Direct Interelectrode Capacitances:\*

Triode Grid to Plate	2.4 $\mu\text{mf}$
Triode Input	1.5 $\mu\text{mf}$
Triode Output	1.1 $\mu\text{mf}$
Grid to Each Diode Plate (Max)	0.03 $\mu\text{mf}$
Number 1 and Number 3 Diode Input (Each)	3.8 $\mu\text{mf}$
Number 2 Diode input	2.2 $\mu\text{mf}$

\*Approximate values without external shield

quency amplifier, it contains 3 high-perveance diodes and a high-mu triode in the same envelope. One of the diodes has a separate cathode connection.

Small size, internal isolation and shielding and low interelectrode capaci-

**TABLE II—CHARACTERISTICS AND TYPICAL OPERATION**

**CLASS A AMPLIFIER: TRIODE UNIT**

Plate Voltage	100	250	Volts
Grid Bias Voltage	-1	-3.0	Volts
Plate Current	0.8	1.0	Ampere
Amplification Factor	70	70	
Transconductance	1300	1200	Micromhos

**DIODE UNIT: EACH UNIT**

Average Diode Current with 5 Volts D-C Applied	20	Milliamperes
--	----	--------------

Note: In a ratio-detector circuit for FM, it is recommended that diodes number 2 and number 3 be used.

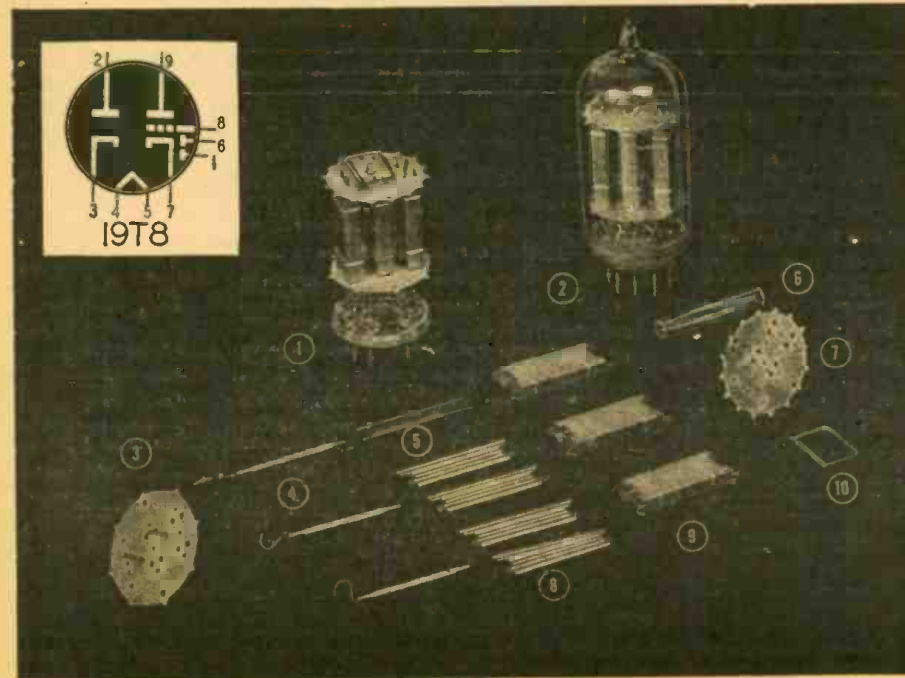

tances adapt the tube to high-frequency operation. Its diameter is 7/8 inch and the height of the glass envelope is 1 15/16 inches, the over-all height with prongs being 2 13/16 inches. Internal capacitances are given in Table 1. Typical operating characteristics are given in Table 2. The tube has the new 9-pin base.

An excellent idea of its internal construction is given in the exploded view photograph, in which 1 is a completely assembled tube without the glass envelope and 2 is the completed tube. The top mica separator is shown at 3, the cathodes at 4, and the triode grid at 5. The plates marked 8 are anodes for the diodes (in one case a shield), while those marked 9 are the plate of the triode circuit and shields for the 2 diode sections. A glass tube containing filaments appears at 6, the bottom separator at 7, and a piece holding the getter strip at 10.

Announced at the same time as the 19T8, the 12AT7 is a miniature twin triode designed for use as a grounded-grid, radio-frequency amplifier or as a frequency converter at frequencies below approximately 300 mc. A center-tapped heater permits operation of the tube from either a 6.3 or 12.6-volt heater supply.

# CRYSTAL OSCILLATORS— A FEW TESTS

THE harmonic-generating crystal oscillator undeniably has advantages for the amateur (especially the higher-frequency) bands. A number of such arrangements have been advanced—notably the tritet with the crystal between grid and cathode, and other types with the crystal between grid and ground. All have either a coil or an r.f. choke tuned with a variable condenser in the cathode circuit. The tritet in particular has come in for considerable criticism because of its high crystal currents as well as instability. Unfortunately some of the better published material on the subject gives figures for crystal current when the tuning is “on the nose,” generally ignoring what goes on when controls are detuned and crystal current multiplies many times. The important parasitic problem is often ignored.

A number of tests were run to ascertain just what could be expected in a typical circuit, without endeavoring to create a “laboratory atmosphere” where circuits always seem to work better than in the average ham shack.

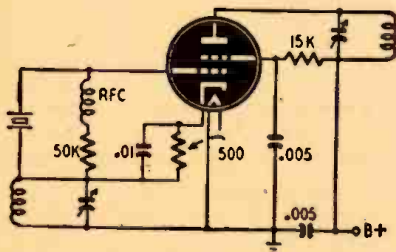

Fig. 1—Standard tritet oscillator circuit.

Fig. 1 is the tritet circuit. About the only variations encountered in this circuit relate to the grid bias. Sometimes the control grid is returned via the grid leak to ground rather than to the cathode, and occasionally cathode bias is omitted entirely. The arrangement shown seems to provide the lowest crystal current for a given output. Inclusion of cathode bias lowers both crystal current and output, but increases the activity, and sometimes the parasitics!

Tables I and II show the results of tests of various common tubes. These tests were run with 40-meter crystals and at a plate potential of approximate-

Tube	2nd	3rd	4th	Crystal Current	Remarks
6F6	X	Fair	Poor	Moderate	Controls Detuned
6F6G	X	Fair	Poor	Moderate	
6V6	X	Fair	Poor	High	
6V6G	Good	Fair	Poor	High	No cathode bias
6V6GT	X	Fair	Poor	High	
6L6	Good	Good	Fair	High	Shell tied to B+
6L6G	X	Good	Fair	High	
RK49	X	Good	Fair	High	
59	Good	Fair	Poor-Nil	Low	
89	Good	Fair	Poor-Nil	Low	
802	Good	Fair	Poor	Low	
RK25	Good	Fair	Poor	Low	
807	X	X	X	High	Absolutely unmanageable.
RK39	X	X	X	High	Absolutely unmanageable.

ly 350 volts with a 15,000-ohm series resistor to the screen providing a screen potential averaging 200 volts. With circuits set up for 80-meter crystals, parasitics were almost entirely absent.

The “X” in Table I indicates that while output may be obtainable it is either all or partially parasitic oscillation, as output persists after the crystal is removed. These parasitics appear to arise from the presence of either suppressor grids or beam-forming plates which are internally connected to the cathode, which is itself tuned near the 2nd-harmonic frequency—This includes all tubes tried except the 59, 89, 802, and RK25. This can be deduced from the fact that (excepting the 89) these last-mentioned will “take off” if their suppressor is externally tied to the cathode. The heater also enters the picture. Making the heater float with respect to ground generally detunes and sometimes removes the parasitic, but the output is markedly lower and crystal current higher then.

Parasitic action is also discouraged to a degree by a heavy load on the stage. Many amateurs who previously had no trouble when driving triode tubes from their oscillators now experience difficulties when exciting 807's or similar tetrodes which require much less driving power.

Crystal current is also a function of the load. The tuned-plate crystal grid oscillator TPXG has its highest crystal current unloaded, while with the tritet the crystal current increases with load. Therefore the designations of low, moderate, etc., in the tables are intended for comparative purposes only. For instance, a very heavily loaded 6F6 tritet might burn out a crystal while a heavily loaded 6L6 TPXG might not. The tables attempt to show the least favorable conditions that would likely obtain, both with respect to crystal current and parasitic activity.

Reducing the cathode L-C ratio will weaken the parasitics, but high ratios are required for good multiplying action, especially if endeavoring to obtain 4th-harmonic output. CAUTION: The cathode circuit should not be tuned near the crystal frequency as very high crystal current will result—regardless of tube used. As the cathode condenser is generally chosen large enough for use with 80-meter crystals, on the other bands tuning should be confined to half capacity and less.

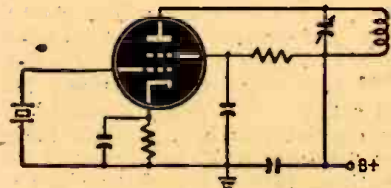

Fig. 2—Tuned-plate crystal-grid oscillator.

Table III details suitable cathode coils derived from the tests—these to be used with a 250- $\mu$ f variable condenser. Output L-C ratios appear to be relatively noncritical if extremes are avoided.

Turning now to the grid-ground crys-

Meters	Turns, coil	Spaced to
80	12	1/4-in. length
40	6	1-in. length
20	4	1-in. length

tal connection of Fig. 3, the parasitic situation still remains serious. Briefly, with all but the 59, 89, 802, and RK25, it was again found that the settings that provide best output of the low-order

(Continued on page 90)

Tube	TPXG	Crystal Current	Remarks
6F6	Low	Moderate	Shell grounded, otherwise dangerous
6F6G	Low	Moderate	
6V6	Low	Moderate	Shell grounded, otherwise dangerous
6V6G	Moderate	High	
6V6GT	Moderate	Dangerous	
6L6	Moderate	Dangerous	Shell grounded or returned to B+
6L6G	High	Dangerous	
RK49	High	Dangerous	
59	Low	Low	
89	Low	Low	
802	Low	Low	
RK25	Low	Low	
807	Moderate	Dangerous	
RK39	Moderate	Dangerous	



# A Two-Tube FM Converter

◀ Meck tuner measures  $7\frac{1}{2} \times 4\frac{1}{2} \times 4\frac{1}{2}$  inches.

**CHEAPEST** and smallest of all the FM tuners or converters offered to date, the Meck FM converter uses only 2 tubes—either a 14F8 and a 35W4 or a 7F8 and a 6H6. Yet the converter is by no means simple. The 2 triodes which compose the 14F8 constitute both a superheterodyne and superregenerative detector.

The action as explained by the instructions supplied to servicemen is as

follows: In addition to serving as a converter-oscillator in the superheterodyne circuit, one section (pins 1, 3, and 4) of the 14F8 double triode functions as a superregenerative detector and i.f. amplifier. The quench oscillation supplied by this section is at the intermediate frequency, hence little energy is radiated from the antenna.

Pins 5, 6, and 8 comprise the other triode of the 14F8, which is used as the

local oscillator for normal superheterodyne action. *Slope detection* is used, with the receiver tuned slightly to one side of the selectivity curve.

The superregenerative circuit has the added feature of automatic regeneration control. The .0025- $\mu$ f condenser and 1,500-ohm resistor in the cathode circuit, together with the 150,000-ohm resistor and .005- $\mu$ f condenser in the plate circuit of the superregenerating triode section, act to set the quench pulse width and average grid repetition rate and control regeneration automatically.

As might well be expected, neither in sensitivity nor quality does this small set equal the larger FM tuners and converters which have been put on the market at higher prices. At a considerable distance from FM stations, difficulty was experienced in bringing in any but the strongest stations satisfactorily. Tuning is accompanied with the familiar superregenerative rush, which disappears when a carrier is tuned in. Quality is subject to the limitations both of slope detection and superregeneration. A certain amount of hum was also noted. This increased considerably when

(Continued on page 88)

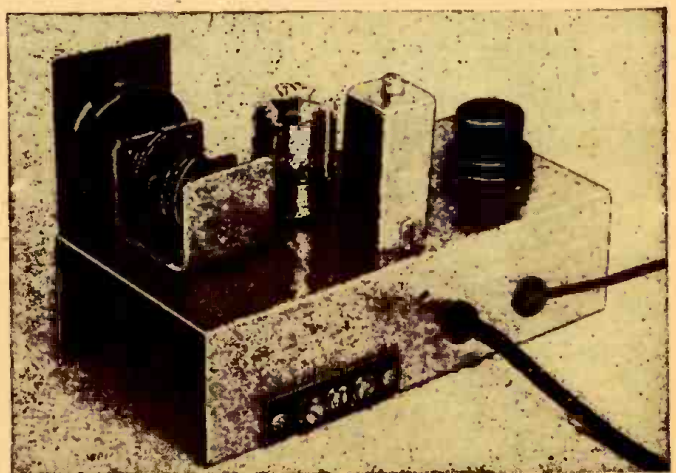
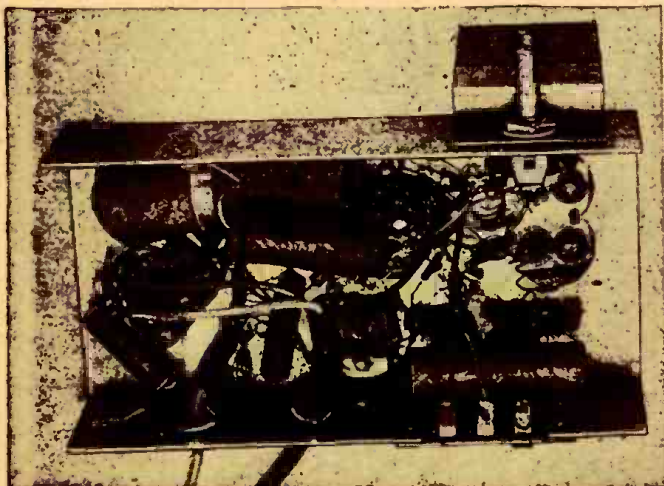
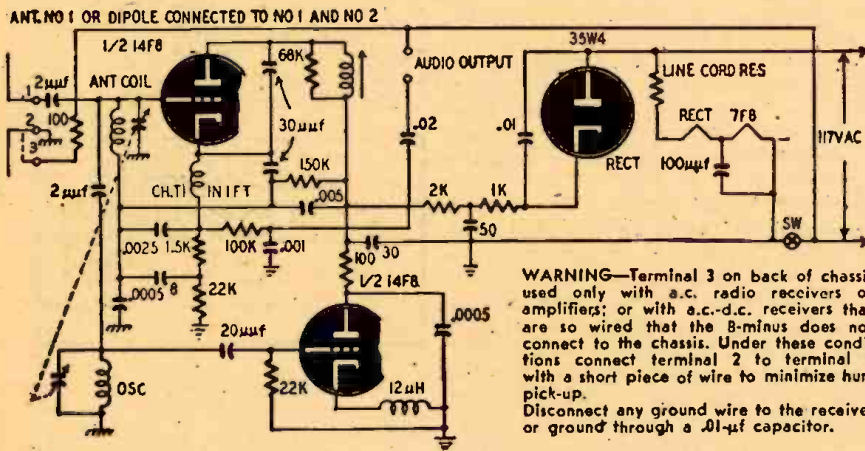

Schematic diagram (above) bottom and rear-chassis views of the Meck FM tuner. High-frequency coils are below variable condenser.



# A. F. Wattmeter Tests Speakers

By I. QUEEN



It is more difficult to judge sound level from a loudspeaker than it is to estimate sensitivity, band width, or other characteristics of a receiver. Accurate measurement of acoustic power is beyond the reach of servicemen, since it requires laboratory equipment. Therefore the output of a radio receiver or audio amplifier is usually specified in terms of the electrical power it can deliver to its speaker. The efficiency of the speaker itself is not taken into account.

Direct measurement of power at audio frequencies also is difficult and there are few instruments available for this purpose. This means that public address and radio technicians have to rely upon indirect measurements which involve some calculation. A common method is to connect a suitable voltmeter across an amplifier resistive load  $R$  and find the

power by the formula  $\frac{\text{volts}^2}{\text{ohms}} = \text{watts}$ .

An alternative method is to connect an ammeter in series with the load. The equation is then  $I^2R = w$ .

If a number of measurements are to be made, say with different inputs and adjustments, the calculations take a lot of time and become bothersome.

The instrument described here is a direct-reading a.f. wattmeter. It is designed to operate across a low impedance such as the secondary of a speaker output transformer. The usual impedance values, 4, 8 and 16 ohms are provided. Intermediate values lead to slight errors which may be disregarded. When the impedance switch is turned to 8 ohms, the panel meter reads directly in watts. It is a 0-200 microammeter which, as connected here, reads 0-20.0 watts. At 4 ohms and at 16 ohms, the indications are " $\times 2$ " and " $\div 2$ " scales, respectively. This corresponds to the fact that low-impedance voice coils are made to handle less audio power. The meter has its greatest power-handling capacity on high-impedance voice coils, which are more commonly used in large amplifiers.

The wattmeter operates on a very simple principle. A 6SQ7 tube is adjusted as a square-law rectifier so that the plate meter reads in direct proportion to the square of the input voltage. Power dissipated in the grid resistor is also proportional to the input voltage squared. Therefore, the meter can be calibrated to read watts. When properly chosen, the meter is direct-reading.

In addition to the wattmeter circuit,

an auxiliary transitron oscillator and a monitor PM speaker have been included for convenience in testing amplifiers.

The schematic (Fig. 1) shows that the instrument is easy to build. The calibrations are easily made, also. To keep the tube characteristic within its square-law portion, plate and grid voltages must be kept low. These voltages may be adjusted over a limited range and are not critical. The plate voltage is about 120 and the grid bias about 2.2 volts. Plate current should be

less than 1 ma, so it is preferable to use a 500-microampere or an even more sensitive meter. Choice will depend upon the scale desired. For example, a 0-50- or a 0-5-watt scale is obtained when a 0-500 microammeter is used. In this particular instrument we used a 0-200 microammeter, thus obtaining a direct-reading 0-20.0 watt scale. If any other type of meter is used, the circuit and calibration will be slightly different from that described here.

(Continued on page 84)

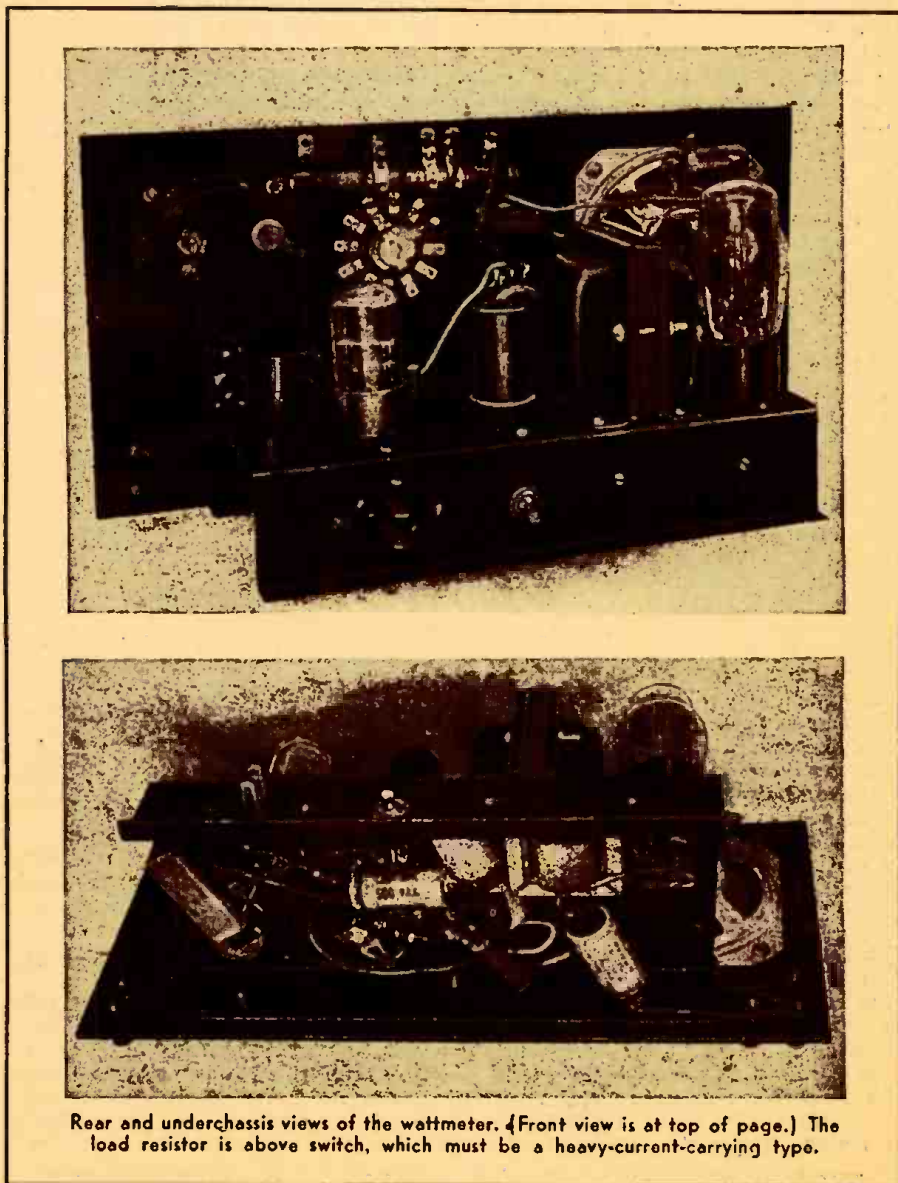

Rear and underchassis views of the wattmeter. (Front view is at top of page.) The load resistor is above switch, which must be a heavy-current-carrying type.

# FM and Television Design

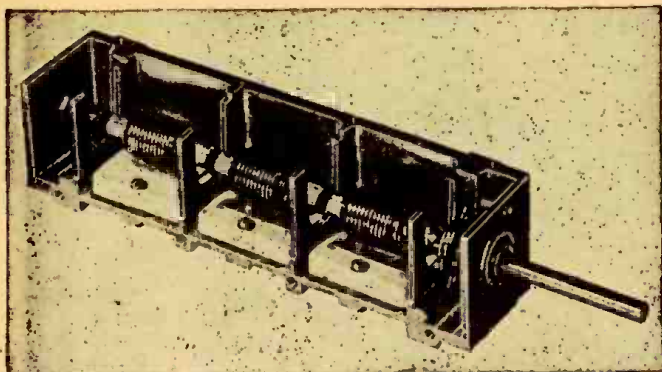

Fig. 1—The Mallory-Ware Inductuner is continuously variable.

## PART II—Special circuits and tuning equipment used for very high frequencies

By MILTON S. KIVER

In the previous article we considered chiefly modification in tubes and their associated circuits in high-frequency receiver design. Now let us note the changes that have occurred in tuning circuits and why these revised circuits are better adapted to deal with the problems of very high frequencies.

In the tuning the high-frequency input circuits of television and FM receivers, the conventional coil and variable condenser combination leaves much to be desired. A variable condenser increases the minimum capacitance across a coil, thereby lowering the L-C ratio and with it the gain. As we tune across a band the capacitance changes, causing the gain to vary over the band. Undesirable coupling occurs between the several sections of a gang condenser. The results are instability, microphonics, and ability of the oscillator voltage to reach the antenna and reradiate to other sets in the vicinity, producing interference.

Coil-condenser coupling between circuits tends to reduce the ability of the various tuned circuits to reject undesired signals. Therefore the present trend among receiver designers has been to use some form of variable-inductance tuning. Coil tuning permits each coil to be used as a separate unit, completely shielded and isolated from similar units. With a variable coil, the fixed capacitance can be kept at a minimum and maximum gain obtained. Variation of inductance produces less variation in Q, and the overall gain and selectivity of the receiver is more constant.

Several types of variable-inductance tuners have made their appearance on the market. These include the *Inductuner*, *Guillotine tuner*, *co-axial-line tuner*, *permeability tuner* and *quarter-wave lines*. Let us examine each, in turn.

**Inductuner:** The Inductuner is a wide-range tuner, capable of continuous tuning from 44 to 220 mc. Because of this wide coverage it can encompass the low and high-frequency television bands and the FM band. It was designed originally by Paul Ware and currently is being manufactured by the P. R. Mallory Company. The unit, with cover removed, is shown in Fig. 1.

It consists of 3 separate variable-inductance units on a common shaft. The coils are wound on ceramic forms, with movable trolley sliders for making continuous contact along the coil. A stop mechanism limits the rotation to 10 turns. Each coil is thus tunable for 10 turns, permitting an inductance variation from 0.02 to 1 microhenry. This represents an inductance change of 1-50,

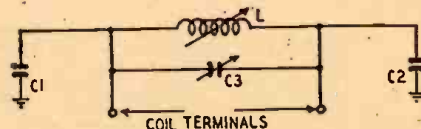

Fig. 2—Equivalent circuit of the Inductuner.

and accounts for the extremely wide band coverage.

The equivalent electrical circuit of the Inductuner, shown in Fig. 2, reveals that 3 capacitances are present. C1 and C2 are stray capacitances from the ends of the coil to ground; C3 is across the coil and consists of 2 parts:

1. A fixed portion representing the interelement stray capacitance,
2. A variable portion which is the distributed capacitance of the winding. The wiring and interelectrode capacitances, plus whatever additional capacitance might be needed to cover the desired tuning band, are also across the coil. Since the Inductuner has 3 separate windings, it is capable of serving 3 stages. The usual 3 circuits so controlled are the r.f., mixer, and oscillator stages, although the amount of inductance required for each circuit may vary.

To achieve such variation, each winding can be modified to serve its particular purpose. Thus, the r.f. and mixer input coils can be used without modification since these cover the same range. The oscillator coil, being above or below the incoming signal, could be altered to the circuit shown in Fig. 3. The oscillator section of the Inductuner is connected in series with a small external inductance. These 2 coils are then shunted by a fixed inductance and a small trimmer capacitor. The shunt coil raises the frequency of that section of the Inductuner and permits the oscillator to function above the incoming signal. If

the oscillator is to operate below the signal, the shunt coil is omitted. The end coil provides the highest frequency of the combination when the inductor trolley has completely short-circuited its own section. The usefulness of the end inductor is that it provides a better Q characteristic than if the variable coil were run out to its limit in order to reach the highest frequency.

The circuit of Fig. 3 is adjusted at its high end with the end inductor and at the low end with the trimmer capacitor. Inductuners are extensively employed in DuMont television receivers.

**Guillotine Tuner:** The guillotine tuner, used in G.E. FM receivers, consists of 2 identical brass frames which form a 2-turn inductance when connected at their open ends. (See Fig. 4.) To vary the inductance of the 2 turns, a brass blade is inserted between the frames. The effect of the brass blade is twofold: it acts as a shorted turn, reducing the inductance of the unit; at the same time the blade shields the 2 turns from each

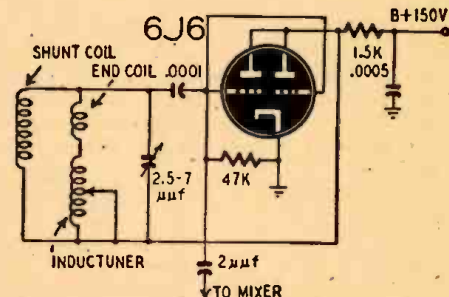

Fig. 3—Inductuner high-frequency oscillator.

other, reducing their mutual coupling. The highest frequency of the tuner is reached when the brass blade is lowered as far down as it will go between the frames. The resonant frequency is lowest when the blade is raised to its top-most point. Slots are cut in the brass blade to produce the desired tuning curve.

In G.E. receivers, the guillotine tuner covers the old and the new FM bands and 2 or more short-wave bands. The low-frequency ranges are tuned by adding shunt capacitance and by inserting

series inductances in the guillotine circuit. The entire tuner is enclosed in a metal box which shields the unit and keeps dust out. The blades of the tuner are raised and lowered by a plastic elevator which is attached to a windlass. Within the same shielded case are coils for the standard AM broadcast frequencies. These are permeability-tuned, their iron cores being raised and lowered by the same assembly.

Note the difference in the method of tuning between the standard AM bands and the other channels. In the guillotine tuner, the inductance of the frames

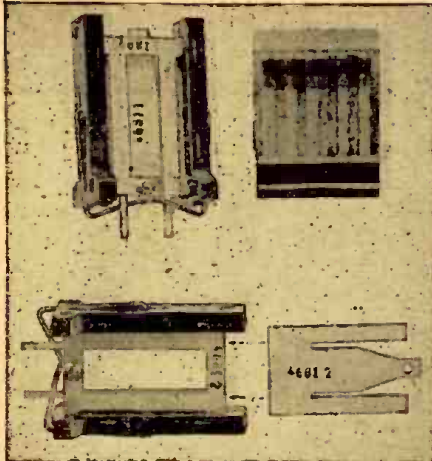

Fig. 4—The Guillotine tuner and its parts. Note the book of matches for size comparison.

decreases as the brass blade is lowered. In the permeability-tuned AM units, the inductance increases when its cores are lowered into the coils.

**Co-axial-Line Tuner:** FM sets manufactured by Motorola are tuned with co-axial-line tuners. To understand the operation of these units, the reader should be familiar with the following facts concerning transmission lines.

A transmission line, whether of the co-axial type, the twisted-wire type, or the parallel-wire line, contains distributed capacitance, inductance, and re-

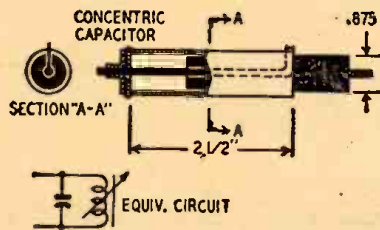

Fig. 5—Design of the co-axial line tuner.

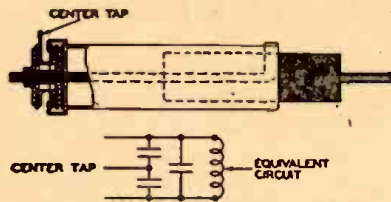

Fig. 6—The tuner with a double capacitance.

sistance. By combining these 3 components, we can cause the line to resonate at different frequencies like a conventional coil and condenser tuning combination. It is the length of the transmission line which determines the resonant frequency, because the length of the line determines the amount of reactance and resistance in the circuit.

In the transmission-line tuner used by Motorola, a co-axial cable was chosen because of the effectiveness of a grounded outer conductor in confining all the

r.f. energy within the cable. The shielding can be made so effective that removal of the antenna causes the signal to disappear completely. Fig. 5 is a cross-section view of the permeability-tuned co-axial cable. It contains an outer conductor, an inner conductor and, between the two, a powdered-iron core. The ratio of the diameter of the outer to inner conductor is approximately 10 to 1, this value having been found to give maximum impedance. The iron core is mounted on a threaded rod so that its position within the line can be varied. Moving the core into the line increases the line inductance.

To have the tuner track accurately with the other co-axial tuners, an inexpensive silver-mica capacitor is constructed on the closed end of the co-axial line. (See Fig. 5.) In the circuit, a Colpitts oscillator required a dual concentric condenser. Its construction can be seen in Fig. 6. The circuits are aligned at the high-frequency end by adjusting the capacitance and at the low-frequency end by adjusting the initial position of the iron cores. The movable iron cores of each co-axial tuner are mechanically ganged and moved in unison.

The adaptation of the co-axial tuner  
(Continued on page 68)

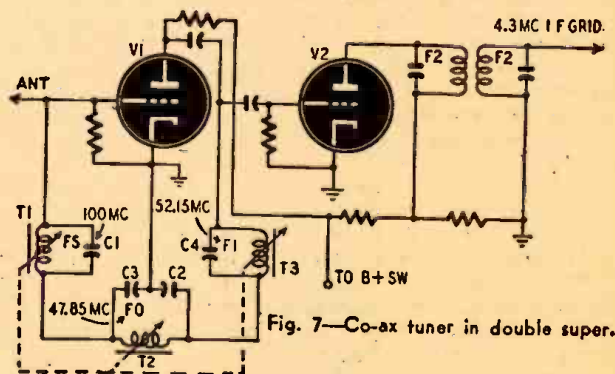
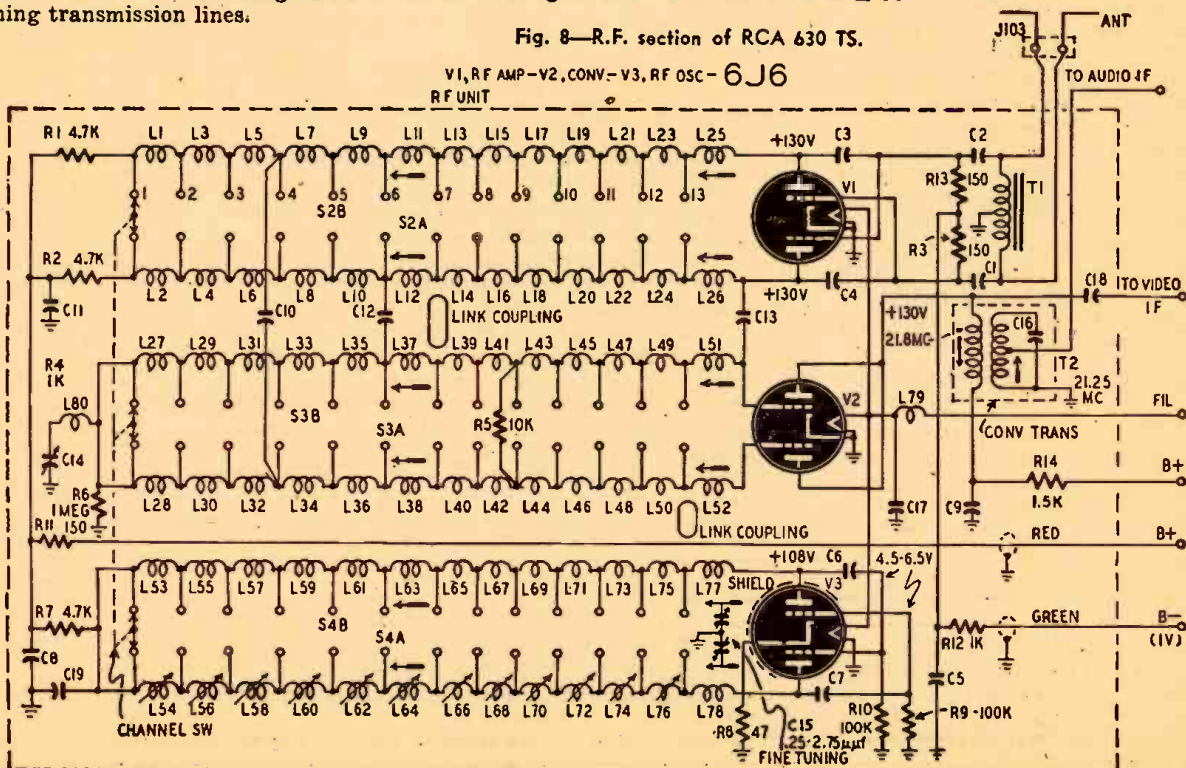

Fig. 7—Co-ax tuner in double super.

Fig. 8—R.F. section of RCA 630 TS.



# HIGH-RANGE OHMMETER HAS EXPANDED SCALE

By L. WALTNER

**A**N OHMMETER that will read high values of resistance, say from 10,000 ohms to 10 or more megohms, is ever needed in the service shop. Such values of resistance are already quite common in modern receivers and are likely to become more so.

The resistance meter found in most service shops, built around a milliammeter of 0-1 ma, is supposed to read up to 1 megohm. This instrument is not linear, and there is serious crowding of markings from about 30,000 ohms upward, so that readings become uncertain and may actually fall far from the real value.

The ultimate value of 1 megohm, up to which the meter is supposed to read,

an old power transformer, a tube with quick heating filament, and a 0-1 milliammeter, besides the usual hardware. The wiring diagram (Fig. 1) shows the simplicity of the hookup. T is an old power transformer with filament winding for the tube. Half the secondary is left unconnected, provided of course that the other half will supply a voltage of not less than 300. The rectifier tube V may be a directly heated triode, such as a 71, an 80, or other rectifier. C is an electrolytic capacitor of 8 $\mu$ f and 450 volts working voltage. Very little filtering is required, as the remaining a.c. ripple has no perceptible influence on the reading of the meter. Rp is a carbon-type potentiometer of 150,000 ohms, and R is a fixed resistor of 250,000 ohms.

## Calibration

The next point to be considered is the calibration of the instrument. To avoid spoiling the dial of the meter with untidy pencil markings, a separate scale can be drawn. A numerical table with dial readings placed side by side with the corresponding resistance values is not altogether satisfactory. It is a slow and uncertain process to interpolate between readings, and errors in computation are frequent. Much better is a double scale showing dial numbers and ohmic values one above the other, as it is sufficient to compare the setting of the pointer with the scale to ascertain the value of the resistor under test. This scale can be straight, like the scale of a slide rule, and if pasted horizontally underneath the meter, works very well.

The 150,000-ohm potentiometer is used to adjust the pointer to zero resistance. To do this easily, a bell-push (Bp) for short-circuiting the test prods is provided. When the ohmmeter is to be used, the switch is closed, the potentiometer adjusted for maximum reading, 1 ma on the scale of the instrument.

One word of caution: There is voltage on the points of the test prods and the operator should use care in handling them. Test prods of high-quality insulating material must be used. The instrument is so sensitive that inferior test prods of poor cables will give a reading of several megohms when touched by the hands. Current will flow through the prods and the body of the operator. However, no inconvenience is caused by the high voltage, since the current is limited to a maximum of 1 ma which is not likely to do any harm.

Actual calibration can be made with good resistors of known value. When several resistors of the silver-tipped type and of identical value are tested one after another, a mean value of sufficient accuracy for practical purposes is obtained.

The instrument can be calibrated by computation also. As it is going to read from 10,000 ohms upward, the internal resistance of the meter can be neglected. In the hypothetical case of the transformer giving an exact 300 volts, the sum of Rp plus R would have to be exactly 300,000 ohms, if a 0-1 ma meter is used. By placing another resistor of 300,000 ohms between the test prods the total resistance in the circuit is doubled,  $\frac{1}{2}$  ma flows, and the pointer on the instrument stops exactly on the marking 0.5. It follows that the 300,000 mark falls in midscale. The lower half of the scale will have to cover the values of say 10,000,000 ohms to 300,000 ohms, or the large difference of 9,700,000 ohms, whereas the upper half takes care of only 10,000 to 300,000, or 290,000 ohms. Serious crowding at the left and right ends of the meter will result.

(Continued on page 80)

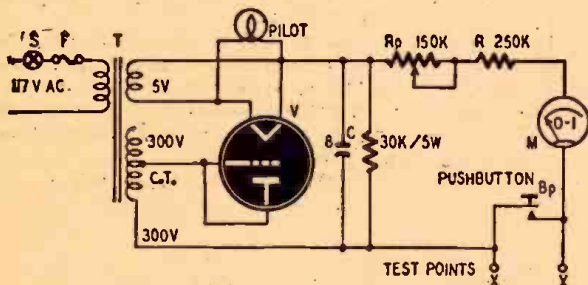

Resistors up to 10 megohms are measured accurately with this circuit.

looks on the instrument like infinity. An open resistor of 1 megohm and one in good condition will give almost identical readings.

An ohmmeter that will give good readings between 10,000 ohms and 10 megohms can be constructed easily and cheaply. It will be of great help, not only for testing resistors, but also for finding leakage through defective dielectrics and for testing electrolytic condensers.

## The circuit

The ohmmeter meeting the above specification requires nothing more than

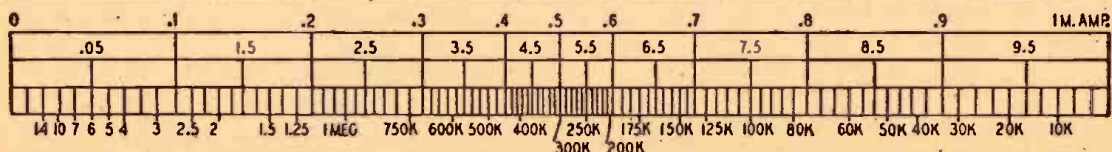

By exaggerating the scale, readings at the normally crowded ends become easier to interpret. The millimeter scale is at the top.

This 4-tube FM set may also be used as a tuner

By E. E. SHOPEN

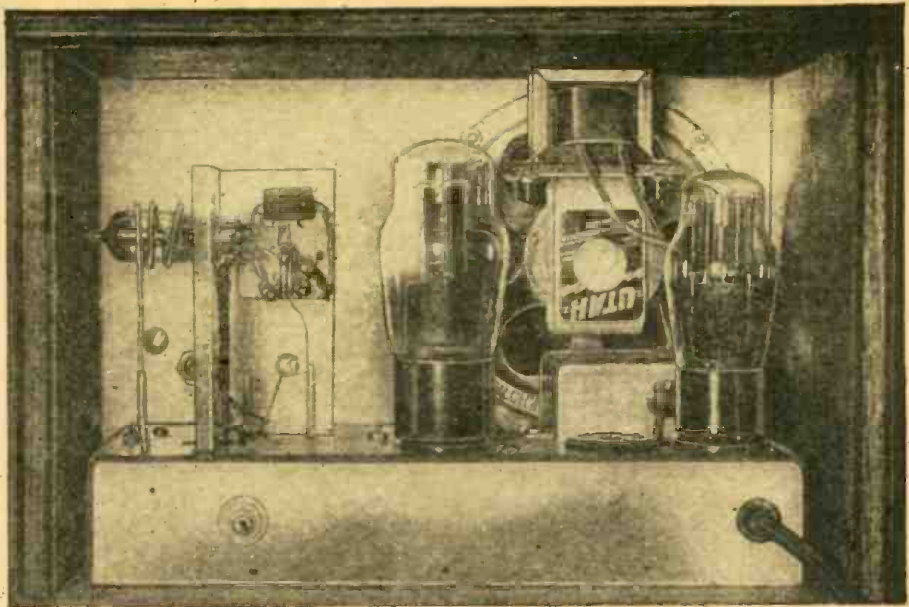

The high-frequency detector circuit (at left) is very clearly seen in this photograph.

THE midget FM receiver has been dubbed a "blooper," since that is the nickname given to the super-regenerative circuit which is used. The circuit is neither new nor unusual—it was discovered by Major Edwin H. Armstrong a few decades ago. It has simply been adapted to reception of FM broadcast signals. (The superregenerative circuit will respond to both AM and FM signals.) Good signal strength is required from the FM station or the quality of reception will suffer.

All parts for the set are easily obtainable, and many hams will find that they have most of them on hand. The set uses 4 tubes: a 9002, a 25Z5, a 6SF5, and a 43. Other tube combinations could be used, but these tubes are available and therefore recommended.

The 9002 is especially important, since it is very sensitive at FM frequencies. To keep losses down a polystyrene socket must be used with it. All leads in the 9002 circuit should be kept very short. The other tube circuits are conventional and can be wired in the usual manner. Condenser C1 must be ruggedly mounted (Pilot claims the heavy copper-plate condenser in the Pilotuner prevents drifting) and kept as far from the chassis as convenient. It must be insulated from the chassis, of course. Coil L is mounted directly on the condenser.

The 9002 tube is mounted close to the condenser and coil to keep the leads short. The mechanical coupling between condenser and dial is made through an insulated coupling; and the shaft from the coupling to the dial is a bakelite rod, thus eliminating hand capacitance.

The set pictured uses lucite to support the tuning condenser. Bakelite could be used as well. Even tempered Presdwood would do if given a few coats of shellac or lacquer.

Since all superregenerative sets are critical in antenna coupling, a noncritical system was devised. Three or 4 turns of wire from the antenna lead-in are wrapped around the glass envelope of the 9002 tube. Plenty of coupling is obtained and any length of antenna can be used, although a piece of wire about 2 feet long is usually adequate. It has been found that a single-turn coil loosely coupled to L is usually more satisfactory than the antenna connection just described. The coupling is critical however and too much will keep the detector from superregenerating. The loop-type coupling has the advantage that a standard doublet or other receiving-type antenna can be used. Both methods are shown in the diagram.

This receiver will re-radiate slightly,

## "Super-R" FM Receiver

and may cause interference to other FM receivers. For this reason the antenna should be kept as short as possible. An r.f. stage ahead of the detector virtually eliminates the re-radiation.

Any convenient chassis layout can be used. A vernier tuning dial is recommended. The regeneration control is not critical. The set is quite stable and does not drift.

Condenser C1 should be about 10  $\mu\text{f}$ . Hammarlund and Bud each make a

15- $\mu\text{f}$  condenser consisting of 2 rotor plates and 1 stator. If 1 rotor plate is removed and the coil dimensions are adhered to, the set will tune from 86 to 112 megacycles.

If only an FM tuner is required, the 43 may be omitted and output terminals installed as shown by the dotted lines. Output will be greater than in most FM tuners because of the 6SF5 audio tube in the tuner.

(Continued on page 75)

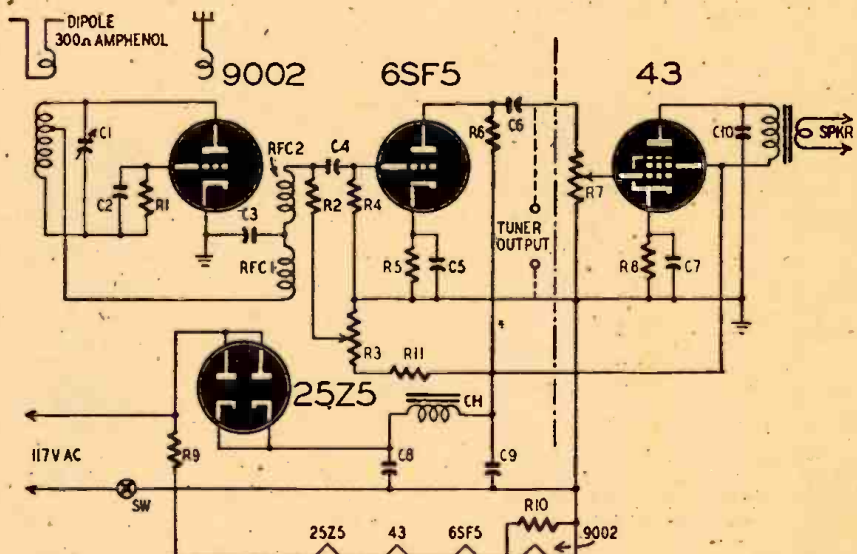

Schematic of the 4-tube superregenerator, showing the alternative antenna arrangements.

- L—4 turns No. 14 1/2-inch inside diameter spaced to 3/4-inch. Tap is 1 3/4 turns from plate end
- C1—See text
- C2—50  $\mu\text{f}$  mica
- C3—.001 to .004 (See note 1)
- C4, C6, C10—.01  $\mu\text{f}$
- C5—.5  $\mu\text{f}$
- C7—20  $\mu\text{f}$ , 25 volt
- C8, C9—30  $\mu\text{f}$ , 150 volts
- R1—10 megohms
- R2—50,000-ohm, 1 watt
- R3—50,000-ohm potentiometer (regeneration control)

- R4—1/2 megohm
  - R5—6,000 ohms
  - R6, 11—100,000 ohms
  - R7—250,000-ohm volume control with switch
  - R8—501 ohms, 1 watt
  - R9—200-ohm line cord resistor
  - R10—25 ohms, 2 watts
  - RFC1—25 turns No. 26 to 30 cotton-covered on 1/4-inch, close-wound
  - RFC2—2 1/2 turns to 80- $\mu\text{h}$  choke
  - CH—Filter choke or speaker field
- Note 1: C3 is critical; experiment for best results.

# MAGNETIC RECORDING

Part III of a series, the first two parts of which were headed Magnetism. This part deals with recorder design. Next will be construction of a practical tape recorder

By A. C. SHANEY\*



Courtesy Brush Development Corp.

Fig. 1—The Mail-A-Voice uses magnetic discs.

ONE of the most important elements in any magnetic recording process is the magnetic carrier (the material upon which the magnetic modulations are impressed or recorded). Magnetic carriers which have been used successfully to date include metallic ribbon and wire, nonmagnetic ribbon and wire plated with special magnetic coatings, and magnetically coated and impregnated paper and plastic tapes. Early experimenters successfully applied magnetic modulation to a magnetically coated cylinder. A magnetic recorder and playback device which is now available (Fig. 1) utilizes magnetically coated thin paper discs. This list is merely suggestive and by no means exhausts all the possibilities. For example, it should be both economical and practical to coat or impregnate magnetically plastic or cotton fiber thread or other artificial fiber.

The actual magnetic properties of the magnetic carrier determine, to a considerable degree, the over-all performance characteristics of the recording and playback system. They also play an important determinative factor in the design of all other essential elements and auxiliary components used in both the magnetic recording and playback processes.

Many early and highly qualified technicians experimenting with magnetic recording failed to evaluate properly all effects which were normal functions of carrier characteristics, and as a result came to erroneous conclusions. For example, it was believed (during 1932) that it was necessary to run a magnetic carrier at a speed of 393.7 inches per second to obtain a frequency response up to 5,000 cycles. As a result, it was fallaciously concluded that the necessity for the high speed "restricts the application of this recording method to reproduction in the speech range." Today in

\*Chief Engineer, Amplifier Corp. of America.

contrast, a commercially available unit (Fig. 2) is capable of recording and reproducing up to 5,000 cycles with a carrier speed of 4 inches per second—a reduction in carrier speed of nearly 100 times without affecting frequency response, attaining, at the same time, many other desirable improvements in noise reduction, increased dynamic range, and lower distortion! Nine thousand cycles has been recorded and played back at a carrier speed of 7½ inches per second, and 12,500 cycles has been attained at a tape speed of 15 inches per second. (Magnetically coated paper tape was used to attain the indicated results.)

The rate of progress in the art of magnetic recording can be measured by the carrier speed of the magnetic medium employed. Slow speeds (with desired frequency response) indicate greater economy of the magnetic medium and longer playing time for a given length and cost of material.

Progress in this respect has been little short of phenomenal. For example, in 1932 118,000 feet of wire was required for a 1-hour program reproducing up to 5,000 cycles. In 1943 the same program quality and duration could be maintained with 11,000 feet of wire. By 1946, it took only 1,250 feet of coated tape to duplicate the same program!

All students of radio have been correctly impressed with the idea that the rate of radio wave propagation (radio carrier speed) is constant (300,000,000 meters per second). As a result, it is simple to calculate wave length—the distance through which current will travel within one cycle—from the following well-known formula.

$$\lambda = \frac{k}{f} \quad (1)$$

Fig. 2—This machine records 12,500 cycles.

Courtesy Amplifier Corp. of America

when  $\lambda$  = wavelength,  $f$  = frequency, and  $k$  = carrier speed (186,000 miles per second or 300,000,000 meters per second).

In magnetic recording, the carrier speed is not a fixed and unvarying constant. In fact, as previously explained, there is a strong tendency to continually decrease its speed without affecting over-all response. As a result, the magnetically recorded wavelength of a given frequency will be a function of the magnetic carrier speed and can be found from this simple expression:

$$\lambda = \frac{s}{f} \quad (2)$$

when  $s$  = magnetic carrier lineal speed.

Thus a 5,000-cycle signal when magnetically recorded on a tape running 7½ inches per second will have a wave length of 1.5 thousandths of an inch. Similarly, a 5,000-cycle signal recorded at a carrier speed of 4 inches will have a wave length of 8 ten-thousandths of an inch.

When it is realized that each complete wave length has 4 phases (see Fig. 3), evidently each phase of 8 ten-thousandths of an inch wave length will be only 2 ten-thousandths of an inch



long (approximately 5 microns). We begin to get an idea of the minute dimensions involved in attempting high-frequency magnetic recording on slow-moving media.

### Carrier speed stability

A casual examination of the formula (2) relating wave length to speed and frequency indicates that if the magnetic wave length is constant (and it is, if a fixed frequency has been recorded at a constant speed) the reproduced frequency will be directly proportional to lineal speed. If the lineal speed of the magnetic medium should vary for any reason whatsoever, the reproduced frequency will similarly vary. This produces a noticeable variation of frequency when sustained tones are reproduced and resembles the turntable "wow" common to disc recording and reproducing systems which do not employ absolutely constant-speed turntables. To minimize any instantaneous speed variations, it is important to avoid eccentricities in any of the driving members involved in pulling the magnetic medium past the playback head. A correctly designed flywheel should be used to smooth out cyclic pulls common to "constant speed" synchronous motors. A correctly designed capstan drive and flywheel is illustrated in Fig. 4.

The load applied to the driving motor should be constant. Bent reels or spools which scrape either the recording medium or adjacent surfaces are the most common cause of frequency variations in a properly designed mechanism. An idea of the desired constancy of linear speed may be gained from the already established data which indicates that an average listener can detect frequency deviations in the order of 3/10 of 1% (3 parts in 1,000) within the frequency range of 400 to 5,000 cycles. Therefore, instantaneous lineal speed variations should be no greater than  $\pm 0.1\%$  (which allows a variation of 2 parts in 1,000).

### Magnetic carrier compliance

Early experimenters who attempted to increase the high-frequency response of magnetic recording systems by increasing wire speeds were bothered by pronounced variations in signal level mainly caused by wire "flutter."

A stiff wire travelling at high speed will tend to assume some natural period of vibration dependent upon its thickness, tautness, and the distance between its supports. Flutter (a transverse vibration) produces a minute frequency variation "wow" (because a slight change in lineal speed takes place), but more important, it introduces a varying pressure against the recording head which in turn changes the air gaps between the magnetic medium and its pickup head. These minute variations produce appreciable high-frequency level fluctuations characteristic of flutter. Steel tapes travelling at high speeds are similarly afflicted. Paper and plastic tapes, because of their increased compliance and slow speeds, are more easily passed by the pickup head with negligible flutter effects. On

the other hand, their increased compliance makes it necessary to use pressure fingers to keep the tape pressed, at a relatively fixed pressure, against the recording and playback heads.

### Dimensional stability

When discussing lineal speed stability and its relation to "wow," it was assumed that a magnetically recorded fixed-frequency signal would maintain a fixed wave length.

This is true as long as the wire or tape doesn't stretch. If stretching does take place, because of temperature and humidity changes between the recording and playback process (and it may, because of the tensions or pull applied to the medium during recording, rewinding, and playback), we then have a new variable to consider.

A simple transposition of formula (2) produces

$$s = \lambda f \quad (3)$$

which indicates that if the speed remains constant, the reproduced frequency is inversely proportional to wave length. In other words, if the magnetic medium stretches the wave length increases and reproduced frequency decreases! This effect will not be noticeable as long as the "stretch" or dimen-

sional stability is within  $\pm 0.1\%$ . Plastic tapes and thin wires naturally will have some tendency to stretch. The paper base used for coated tape is made of carefully selected material and treated by prestretching for improved dimensional stability.

As expected, one of the most important elements in magnetic recording and playback is the actual magnetic and physical properties of the magnetic carrier. In a magnetic coated medium, the coating itself, and not the base, plays the most important role in the process.

Some of the more critical factors which determine the efficiency, noise, response, constancy of output, overload characteristics, and velocity of the carrier include its coercivity, remnance, particle size, binder, dispersion, chemical composition, surface smoothness, and coating thickness.

Each of these characteristics has a profound influence upon the overall characteristics and performance of the recording and playback system.

A brief discussion of these factors together with the design details of a suitable magnetic recording amplifier will be covered in the next issue.

Two transpositional errors occurred in the October installment of this series. In comparing the conductivity of electric and magnetic circuits, the formulae should have been:

$$G = \frac{I}{E}$$

$$\mu = \frac{B}{H}$$

G = conductance in mhos  
E = e.m.f. (volts)  
I = current (amps)  
 $\mu$  = permeability  
H = magnetomotive force (oersteds)  
B = magnetic flux (gausses)

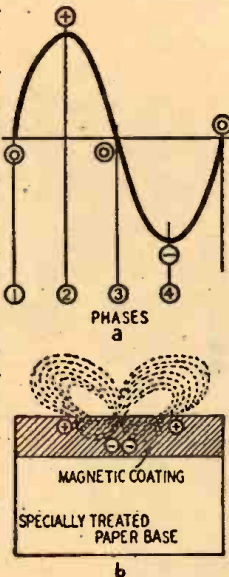

Fig. 3-a—Four phases of sine wave. 3-b—Enlarged cross section of paper tape to show internal and external magnetic flux lines.

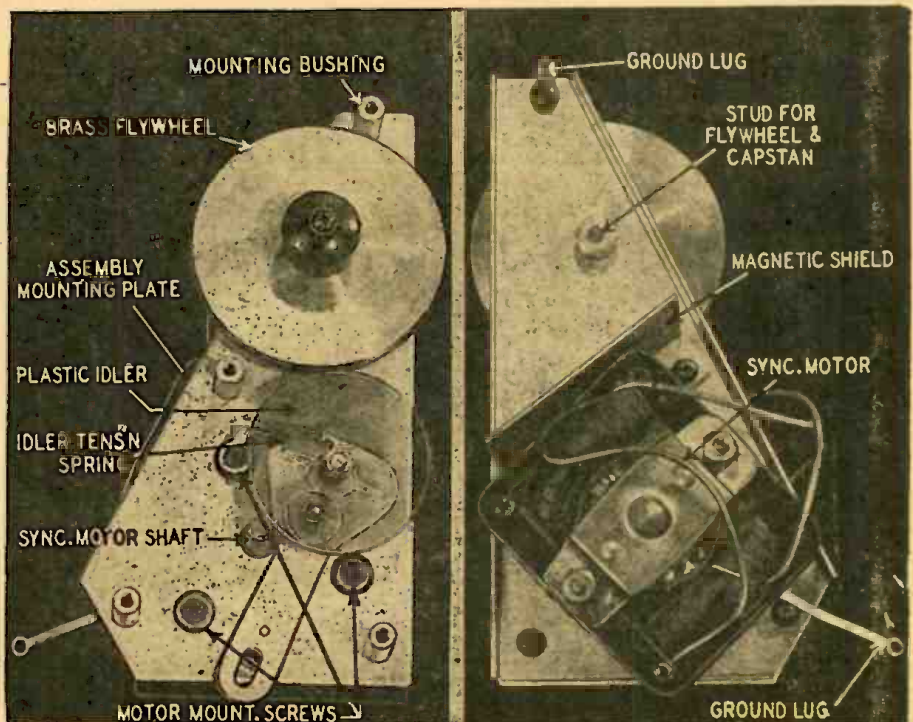

Fig. 4—A correctly designed "tape puller" for magnetic recording and playback devices.

# WORLD-WIDE STATION LIST

Edited by **ELMER R. FULLER**



Elmer R. Fuller, Shortwave Editor of RADIO-CRAFT, is recording shortwave broadcast stations with the help of his Panadaptor, at his observation post in Cortland, N. Y.

**W**HAT has happened to the dx? This is the poorest month in half a year. Several reports were received, but they contained no dx to speak of. Reports were received from one of our old observers who has not been heard from in several years, Ed Lendziczek

of Easthampton, Massachusetts. Ed was an observer before the war, and one of our best observers. Welcome back Ed, and may you have plenty of good dx to report to us soon! Others reporting this month were Charles Luckett of Roselle, New Jersey; Gilbert Harris of North Adams, Massachusetts; Charles

Sutton, of Toledo, Ohio; Charles Fuller, of Cortland, New York; the Australian News Agency of New York City; the British Broadcasting Corporation of New York City; the Canadian Broadcasting Corporation; and the United States Department of State, Washington, D. C.

HHCN of Port-au-Prince Haiti is being heard regularly on 5.660 megacycles; reported heard on the east coast at 1900. DSB has been heard from Hamburg on 17.550 megacycles calling PPS2 at Rio de Janeiro, Brazil. This communication was heard at 1338.

Ten-meter ham phone has been very active. F8US, F8MX, F8TU, F9EH, PAXZ, PAVH have been heard by Gil Harris in North Adams, Massachusetts. Heard here by your editor on ten are several from England, Scotland, Ireland, Brazil, Colombia, Peru, Argentina, France, Germany, the Netherlands, and Australia.

A new station is being heard on 10.970 megacycles from 1730 to 2030. They sign off with Dutch music. Does anyone know who it is? It was first reported to us by Gil Harris.

Berne, Switzerland is being heard from 2030 to 2200 on 6.350 megacycles and 9.650 megacycles. A woman is generally the announcer, although a man is heard occasionally making the announcements. FZI is reported to be using 9.430 megacycles evenings with the programs generally in English. The sign-off is at 2130 with chimes.

All schedules Eastern Standard 24-hour time.

Freq.	Station	Location and Schedule	Freq.	Station	Location and Schedule	Freq.	Station	Location and Schedule
7.230	GSW	LONDON, ENGLAND: 0100 to 0115; 0130 to 0330; 0600 to 0645; 0700 to 0730; 0745 to 0900; 1045 to 1130; 1 30 to 1430; 1530 to 1715	8.030	FXE	BEIRUT, LEBANON: 0915 to 0115; 0525 to 0830; 1000 to 1600	9.500	XEWX	MEXICO CITY, MEXICO: 0800 to 0200
7.240	VLQ	BRISBANE, AUSTRALIA: 1500 to 1900	8.560	AFN	MUNICH, GERMANY: 0400 to 1200	9.500	01X2	LAHTI, FINLAND: 1100 to 1800
7.250	PJCI	WILLEMSTAD, CURACAO: 1130 to 1230 1630 to 2130	8.700	COCO	HAVANA, CUBA: 0700 to 2330	9.510	JLG2	TOKYO, JAPAN: 0300 to 0830
7.250	GW1	LONDON, ENGLAND: 2345 to 2400;	8.720	COJK	CAMAGUEY, CUBA: 2000 to 0030	9.520	VLW7	PERTH, AUSTRALIA: 0530 to 1030; 1700 to 2045
7.260	GSU	0800 to 0200; 0680 to 0645; 0700 to 0800; 0815 to 0900; 1045 to 1800; 1930 to 1700	8.830	COCQ	HAVANA, CUBA: 0130 to 0030	9.520	ZRG	JOHANNESBURG, SOUTH AFRICA: 0300 to 0700
7.260	JVW	TOKYO, JAPAN: 1500 to 0830	8.950	COKG	SANTIAGO, CUBA: 1830 to 2325	9.520	OZF	COPENHAGEN, DENMARK: 1330 to 1800
7.270	VUD8	DELHI, INDIA: 0600 to 0700; 1115 to 1815; 1830 to 1915; 2100 to 2200	9.030	COBZ	HAVANA, CUBA: 0700 to 0100	9.520	JLU2	TOKYO, JAPAN: 0600 to 1200
7.280	VLC8	SHEPPARTON, AUSTRALIA: 1015 to 1045	9.080	CNR3	RABAT, MOROCCO: 0100 to 0330; 1300 to 1700	9.530	WGED	SCHENECTADY, NEW YORK: South American beam, 1900 to 2400
7.280	JLW	TOKYO, JAPAN: 0200 to 0800	9.120		BALIKPAPAN, BORNEO: 0700 to 0935	9.530	SBU	STOCKHOLM, SWEDEN: 0130 to 0145; 1330 to 1700; 2000 to 2100
7.290	VUD3	DELHI, INDIA: 0500 to 1010; 1730 to 1825; 2040 to 2245	9.160	CR6RB	BENGUELA, ANGOLA: 1330 to 1430	9.540	VLR	MELBOURNE, AUSTRALIA: 1620 to 1900; 2045 to 0220
7.290	ZOY	ACCRA, GOLD COAST: 1045 to 1300	9.180	HEF4	BERNE, SWITZERLAND	9.540	LKJ	OSLO, NORWAY: 0200 to 0230; 0445 to 1700
7.290		ATHENS, GREECE: 1430 to 1530	9.210	HIZG	CIUDAD TRUJILLO, DOMINICAN REPUBLIC: 0530 to 0830; 1300 to 1530; 1700 to 1845; 1930 to 2230	9.540	CJCA	MUNICH IV, MUNICH, GERMANY: East European beam, 1200 to 1700
7.290		MUNICH I, MUNICH, GERMANY: Beam beam, 1200 to 1700	9.230	COBQ	HAVANA, CUBA: 0700 to 2400; 1830	9.540	XETT	EDMONTON, CANADA: 0815 to 0200
7.300		MOSCOW, U.S.S.R.: 1300 to 1800; 1815 to 2100	9.270	COCX	HAVANA, CUBA: 0700 to 2000; 2000 to 2200	9.560		SINGAPORE, MALAYA: 0315 to 0515; 0530 to 1100
7.310	YSN	SAN SALVADOR, SALVADOR: 1300 to 1500; 1600 to 2300	9.361	ZOY	CETINJE, YUGOSLAVIA	9.550		MEXICO CITY, MEXICO: 0700 to 0100
7.320	GRJ	LONDON, ENGLAND: 0000 to 0015; 0645 to 6700; 1045 to 1815	9.370	EAQ	MADRID, SPAIN: 1500 to 1700; 1830	9.550		PARIS, FRANCE: 0130 to 0145; 0530 to 0615; 0630 to 0800; 0915 to 0930; 1145 to 1615; 1630 to 1730; 1745 to 1830
7.380	HEK3	BERNE, SWITZERLAND: 1000 to 1045; 1510 to 1530	9.380	COBC	HAVANA, CUBA: 0700 to 2400	9.540		ALGIERS, ALGERIA: 1230 to 1700
7.570	EAJ43	SANTA CRUZ, CANARY ISLANDS: 0630 to 0800; 1100 to 1200; 1230 to 1800	9.380	DTC	LEOPOLOVILLE, BELGIAN CONGO: 00.0 to 0200; 1045 to 1600	9.560		KOMSOMOLSK, U.S.S.R.: 0100 to 0930; 1100 to 1400; 1545 to 1850; 1700 to 1830
7.640	KUSQ	GUAM: 0400 to 1200	9.420		BELGRADE, YUGOSLAVIA: 0000 to 1230; 1630 to 0845; 1000 to 1045; 1110 to 1125	9.570	KWID	SAN FRANCISCO, CALIF.: Chinese beam, 0700 to 1000
7.850	ZAA	TIRANA, ALBANIA: 1400 to 1800	9.440	FZ1	GENEVA, SWITZERLAND: 1300 to 1500	9.570	WRUW	BOSTON, MASSACHUSETTS: South American beam, 1800 to 1900; 2000 to 2200
7.860	SUX	CAIRO, EGYPT: 1200 to 1800	9.460	TAP	BRAZZAVILLE, FRENCH EQUATORIAL AFRICA: 0000 to 0130; 1100 to 2020			
7.950		ALICANTE, SPAIN: 0730 to 0930; 1530 to 1800	9.470	CR6RA	ANKARA, TURKEY: 1000 to 1615			
			9.480		LOUANDA, ANGOLA: 0115 to 0230; 0630 to 0745; 1400 to 1530			
			9.490	KNBI	MOSCOW, U.S.S.R.: 1500 to 1700; 1830 to 2100; 0000 to 0100; 0530 to 0815; 1100 to 1130			
					DIXON, CALIF.: Japanese-Chinese beam, 0400 to 1000			

(Continued on page 64)



# Transatlantic News

By Major Ralph W. Hallows

RADIO-CRAFT EUROPEAN CORRESPONDENT



**T**HESE notes are written on the eve of the opening of the Radio Exhibition. I have

been privileged to have had a preview of most of the television sets, radio sets, and radio equipment to be seen there. Television has a district of its own at the show—Television Ave., in which a score of manufacturers are showing more than 30 types of receivers. Most of them I know are keenly interested in discovering whether the man in the street is most concerned with cheapness (which means a small image and mediocre fidelity in speech and music reproduction), or with the large image and high-quality sound reproduction, which naturally mean considerable increase in cost.

Certainly in 1938 sets priced at about the equivalent of \$100 met with a very poor demand. People had no use for their 3-inch images. With us the sound accompanying television is a genuine high-fidelity transmission. Those who had heard what a good receiver could do with this speech and music were not attracted by the audio performance of the cheap set. Though there will always be some who do not much mind what they see and hear, so long as it is television, I have long believed that for some years to come television's best chance of success lies in the luxury or semiluxury market. I think that the manufacturer most likely to succeed is the one who offers a receiver showing an image not less than 8 x 5 inches and providing high-grade sound reproduction. Such a television will cost with us from \$350 upwards, but I am sure demand won't be lacking. The most expensive receiver in the show, by the way, is the Baird "Grosvenor" model, priced at about \$6,000! This set displays a picture 22 inches by 19 inches on a flat screen. The radio portion has elaborate tuning arrangements and 11 wave bands are covered. There is also an auto-change phonograph, fitted with a recording unit.

The latest published figures show that there are now 23,000 television receivers in use in England. The increase during the past six months has been at the rate of about a thousand a month, which means that manufacturers' output has been absorbed just about as quickly as it came to the market. That is a gratifying sign, and one hopes that the public

will continue to do the same thing when production is stepped up this autumn.

## Better receivers demanded

By all the rules at least 8,000,000 to 10,000,000 sets should be in urgent need of replacement. The biggest market always had been for the smaller and cheaper receivers. It seemed to be just a case of handing these out as fast as possible and scooping in the profits.

But things didn't work out like that. In the war years people had formed the habit of making the old set do, and servicemen had become increasingly clever at keeping veteran receivers alive. Sets which would normally have been on the scrap heap long before were still functioning and their owners looked forward to replacing them with the wondrous products of wartime technical advances. It had been dinned into them by the lay press that mass-production methods developed during the war years would smash the prices of high-grade sets. But that didn't happen. The cheaper sets offered were often not much better in performance than their counterparts of seven years previously. If you wanted something markedly better than the old receiver it cost quite a

sure, the temperature, and the degree of humidity. This is done in an ingenious way. Each measuring instrument has its own v.h.f. transmitter, sending c.w. modulated by an a.f. varying from 700 to 1,000 cycles according to the reading recorded. The modulation frequencies are controlled by the movements of mu-metal armatures in the fields of tuning inductances. Gold-beater's skin operates that of the humidity transmitter, an aneroid capsule that of the barometric pressure transmitter, and a bi-metal coil that of the temperature transmitter. The receiver on the weather ship is so arranged that incoming signals from any of the 3 balloon transmitters may be brought in either as sounds or visually on the screen of a cathode-ray tube.

## Electrons and the aurora

Displays of the aurora borealis are, I believe, much more frequent in America than here. In the southern parts of England they are comparatively rare, in conspicuous form at any rate. The kind of aurora most often seen here consists of luminous cloud patches, which may pass unnoticed by most people. However, when we do have a big display, short-wave men know that we are in for strange reception effects, particularly on signals coming from northerly or southerly directions. And "northerly" includes a large part of the United States, for radio waves follow great-circle courses, which may be very different from those found by ruling straight lines across the maps of an atlas. Even that is not the whole story, for the Magnetic North Pole, from whose neighborhood Nature appears to center a good deal of her unwelcome broadcasting, is a long way south and west of the Geographic North Pole. Some idea of the efficacy of the aurora in interfering with radio signals has just been given by Dr. A. C. B. Lovell of the Jodrell Bank radio and radar experimental station, situated near Manchester. On August 15 the station received radar echoes from the tip of a streamer of an auroral luminous cloud at a height of about 500 kilometers. Subsequent calculations showed that the electron density in this neighborhood was about 100 times that of the normal ionosphere. As these effects extend downward for a considerable distance, it is no wonder that we complain of large-scale short-wave troubles.

## New all-purpose tube

The newest all-purpose tube to make its appearance here is a very interesting piece of design, with many novel features. (Continued on page 50)

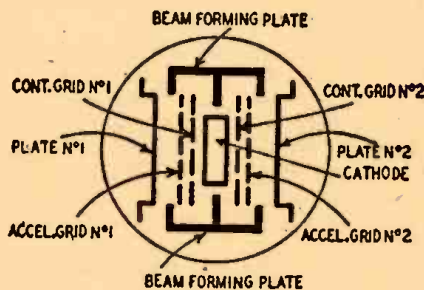

Elements of new Sargrove all-purpose tube.

bit more. Well, the public did—and still does—want something better. Hence it goes for the more expensive receiver when it can afford its price, and continues to make out with the old set when it can't.

## Weather ship radio

Under the terms of the international agreement Britain is responsible for 2 of the 13 floating meteorological stations now permanently maintained in the North Atlantic. To provide the ships on duty and their reliefs, 4 corvettes have been converted and fitted with special radio and radar apparatus. All carry radio-sonde balloons, which rise to heights of 40,000 feet when liberated. The balloons are fitted with miniature radio transmitters, which send out continuous records of the barometric pres-

# FOR FASTER SOLDERING 2 NEW WELLER SOLDERING GUNS

with

## Solderlite



The new Weller Soldering Guns with Solderlite plus the fast 5 second heating help make service work more profitable for radio, television and appliance service men, electrical maintenance men, electric motor rewinding and repair shops, automotive electrical service.

A useful and time-saving tool for laboratory workers, experimenters, hobbyists, telephone installation and maintenance men. S107 100 watts single heat, D207 100/135 watts dual heat.

See your radio parts distributor or write for bulletin direct.

## WELLER MANUFACTURING CO.

824 Packer St., Easton, Pa.

In Canada: Atlas Radio Corp., Ltd., 560 King St., N. W., Toronto, Ont.

Export Dept.: 25 Warren St., New York 7, N. Y.

# TRY THIS ONE

## DUAL-PURPOSE ANTENNA

Here is an antenna system that serves a double purpose at my summer cottage. It makes an efficient antenna as well as a lightning rod. It consists of a lightning arrester, a length of 2-inch iron pipe, and a whip antenna from a No. 19 Mark II or other surplus radio equipment, picked up at a local store.

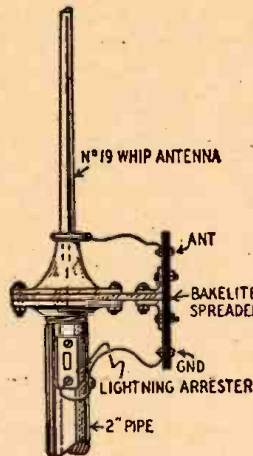

TWISTED PAIR LEADS ATTACH AT "ANT" AND "GND"

The arrester is mounted inside the pipe with internal connections to antenna and ground. External connections to antenna and ground are supported by terminals in a bakelite or plastic spreader. Twisted pair is used between the antenna system and the radio.

P. DAOUST,  
Montreal,  
Canada.

## HANDY BLOWER

If you need a small blower for removing dust from close places in radios and other equipment, you can construct one from an old 6-volt automobile horn and a small power transformer with burned-out high-voltage secondary.

Disassemble the horn and remove the the motor. Remove the small fan from a defective phono motor or make one 3 or 4 inches across from sheet metal. Mount it on the motor shaft. Connect the 5- and 6-volt filament windings in series and wire to the motor leads. A switch in the 117-v, a.c. line completes the blower.

ELLISON RADIO SERVICE,  
Pentertown, Ky.

## IMPROVING PORTABLES

Many travelers and vacationists find their small personal radios almost useless in places far from broadcast stations. Their antennas are usually loops built into the lid of the set, and have not enough signal pickup to receive distant stations. Very few of these sets are fitted for use with an external antenna.

To improve such sets, cut slots around the perimeter of a piece of heavy cardboard, roughly the size of the lid of the set. Wind approximately 100 turns of fine insulated wire, about No. 28 or 30, on the slots in pancake form. Connect the ends of the coil to 10-foot lengths of insulated wire terminated with crocodile clips. These serve as antenna and ground connections.

Connect one of the leads to a good ground, a radiator or water pipe, and

the other to an antenna—bedsprings or window screens can be used in emergencies. Place the lid in receiving position and turn on the set. Place the loop against the lid of the set and experiment with its position to get the best results. Fit a small clip or clamp on the loop so that it can be clamped to the lid in a position that will give best reception.

C. B. BOVILL,  
Morden, England.

## SIMPLE PHOTOMETER

In the article "Lamp Bulb Resistors" in the April, 1947, issue Mr. Parchman suggests that a colored filter or smoked glass be used when comparing the brilliancy of 2 lamps. The paraffin-block photometer is easily constructed and is a more accurate method of making such a comparison.

This device is merely 2 small blocks of paraffin, about 1/2 inch thick, separated by a sheet of tinfoil. The measurements should be taken in as little direct light as possible with the

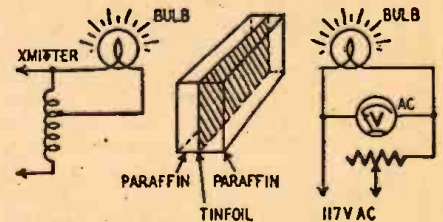

photometer half way between the lamps. The line resistor is adjusted until both blocks are equally illuminated.

A. C. WILSON,  
Ottawa, Ont.

(Such a photometer was described briefly by Mr. J. G. Reed in the article "An Electronic Photometer" in the July, 1947, issue of RADIO-CRAFT.—Editor)

## BREAK-IN KEYING

Simple break-in keying is easy if you add a pair of normally closed contacts to your key. The lower contact is mounted on a thin metal bracket close to the rear of the key. The upper contact is mounted on a strip of bakelite or other insulating material drilled and tapped to pass the thumbscrew used for

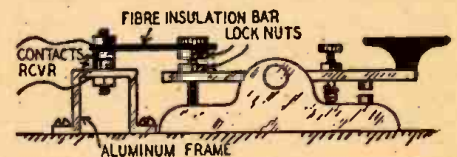

adjusting the spacing between the normal contacts.

The extra contacts may be connected across the receiver send-receive switch or between the center tap of the power transformer and the B-minus lead.

GEORGE I. SCOVILL, W8ECN,  
Mt. Clemens, Mich.

(Contacts which short the set's antenna in key-down position are also good.—Editor.)

**MONEY BACK GUARANTEE** — We believe units offered for sale by mail order should be sold only on a "Money-Back-If-Not-Satisfied" basis. We carefully check the design calibration and value of all items advertised by us and unhesitatingly offer all merchandise subject to a return for credit or refund. You, the customer, are the sole judge as to value of the item or items you have purchased.

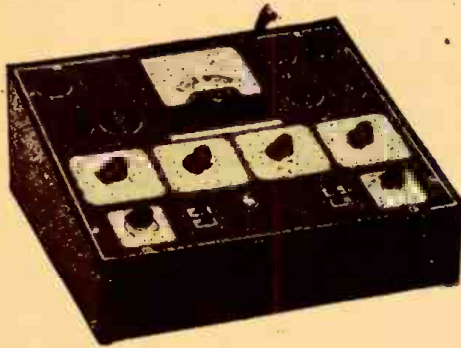

## The New Model 60-T TUBE and SET TESTER

### A COMPLETE TUBE TESTER

Tests all tubes including the new post-war miniature locals such as the 12AT6, 12AU6, 35W4, 50B5, 117Z3, etc. • Tests by the well-established emission method for tube quality, directly read on the scale of the meter • Tests shorts and leakages up to 3 Megohms in all tubes • Tests leakages and shorts of any one element against all elements in all tubes • Tests both plates in rectifiers • Tests individual sections such as diodes, triodes, pentodes, etc., in multi-purpose tubes.

**\$49<sup>85</sup>**

Model 60-T operates on 90-120 Volts 60 Cycles A.C. Housed in sloping leatherette covered cabinet. Comes complete with test leads, tube charts and detailed operating instructions.

NET PRICE

### A COMPLETE MULTI-METER

- 6 D.C. Voltage Ranges: 0 to 7.5/15/75/150/750/1,500 Volts
- 6 A.C. Voltage Ranges: 0 to 15/30/150/300/1,500/3,000 Volts
- 4 D.C. Current Ranges: 0 to 1.5/15/150 Ma. 0 to 1.5 Amps.
- Low Resistance Ranges: 0 to 2,000 Ohms (1st division is 1/10th of an ohm.)
- 2 Medium Resistance Ranges: 0 to 20,000/200,000 Ohms
- High Resistance Range: 0 to 20 Meg-ohms
- 3 Decibel Ranges: -10 to +38, +10 to +38, +30 to +58 DB.

EXTRA: WE CAN NOW SUPPLY THE MODEL 60 HOUSED IN A BEAUTIFUL HAND-RUBBED OAK CABINET, COMPLETE WITH PORTABLE COVER MAKING IT SUITABLE FOR EITHER BENCH OR OUTSIDE USE. ONLY \$2.75 ADDITIONAL. SPECIFY MODEL 60-C

## The New Model 650-A A. C. Operated SIGNAL GENERATOR

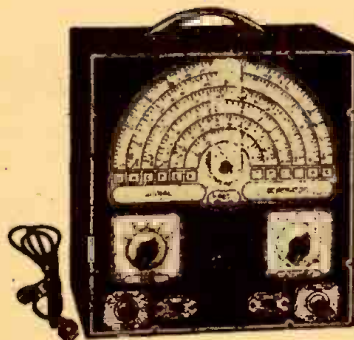

• Operates on 110-120 Volts 50 to 60 Cycles A.C.

• R.F. Frequencies from 100 Kc. to 35 Mc. on Fundamentals in 5 bands by front panel switch manipulation. One additional band provides Harmonics from 30 to 105 Mc.

• Audio Modulating Frequency — 400 Cycles Pure Sine Wave. Distortion less than 2%.

• Attenuation: Features a newly designed 3-step ladder type of attenuator (T pad). The first step provides lowest output and can be multiplied by 10 and by 100 by turning the multiplier switch.

• Hartley Excited Oscillator Electron coupled to a Buffer Amplifier. Frequency stability is assured by modulating the amplifier stage.

Complete with coaxial cable, test leads and instructions. Heavy gauge grey crystalline cabinet with beautiful two tone etched front panel. Size 8 1/2" x 10" x 6".

**\$39<sup>95</sup>** NET

## The New Model 670 SUPER METER

A Combination Volt-Ohm-milliammeter plus Capacity Reactance, Inductance and Decibel Measurements

D.C. VOLTS: 0 to 7.5/15/75/150/750/1500/7500.

A.C. VOLTS: 0 to 15/30/150/300/1500/3000 Volts.

OUTPUT VOLTS: 0 to 15/30/150/300/1500/3000.

D.C. CURRENT: 0 to 1.5/15/150 Ma.; 0 to 1.5 Amps.

RESISTANCE: 0 to 500/100,000 ohms 0 to 10 Megohms.

CAPACITY: .001 to .2 Mfd., .1 to 4 Mfd. (Quality test for electrolytics).

REACTANCE: 700 to 27,000 Ohms; 13,000 Ohms to 3 Meg-ohms.

INDUCTANCE: 1.75 to 70 Henries; 35 to 8,000 Henries.

DECIBELS: -10 to +18, +10 to +38, +30 to +58. The Model 670 comes housed in a rugged, crackle-finished steel cabinet complete with test leads and operating instructions. Size 5 1/2" x 7 1/2" x 3".

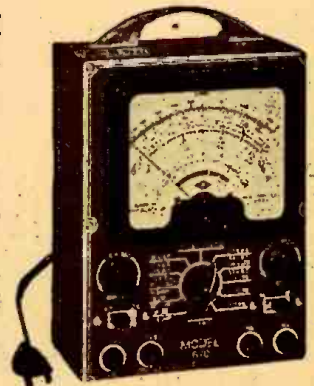

**\$28<sup>40</sup>** NET

## The Premier B-A-N-D-S-P-R-E-A-D DIAL SIGNAL GENERATOR

### Exclusive Feature!

The "PREMIER" Model 570 is the ONLY low-priced Signal Generator with a MICRO-MASTER BANDSPREAD DIAL, equivalent to a scale length of approximately 60" — a major feature for logging, sharp and critical tuning.

AIR TRIMMERS ON ALL BANDS.

TRIPLE COPPER PLATED SHIELDING.

EFFECTIVE LINE FILTER — pure 400 cycle modulation (less than 5% distortion).

Range 75KC-50MC on fundamental, and 50-150MC on 3rd harmonic, useful for aligning FM and Television Receivers.

Accuracy better than 1%.

A.C.—115 volts, 50-60 cycles.

Overall size—12"x12 1/2"x5 1/2". Shpg. wt. 21 lbs. Complete with coaxial cable and complete operating instructions.



**\$54<sup>75</sup>** NET

## The New Model 450 TUBE TESTER

Speedy operation — assured by the newly designed rotary selector switch which replaces the usual snap, toggle, or lever action switches.

### SPECIFICATIONS

- Tests all tubes up to 117 volts. • Tests shorts and leakages up to 3 Megohms in all tubes. • Tests both plates in rectifiers. • New type line voltage adjuster.
- Tests individual sections such as diodes, triodes, pentodes, etc., in multi-purpose tubes. • Noise Test—detects microphonic tubes or noise due to faulty elements and loose internal connections. • Uses a 4 1/2" square rugged meter. • Works on 90 to 125 volts 60 cycles A.C.

EXTRA SERVICE—May be used as an extremely sensitive condenser Leakage Checker. A relaxation type oscillator incorporated in this model will detect leakages even when the frequency is one per minute.



**\$39<sup>50</sup>** NET

**GENERAL ELECTRONIC DISTRIBUTING CO.** DEPT. RC-12, 98 PARK PLACE, NEW YORK 7, N. Y.

# LEONARD'S

FALL PRICES

BEST VALUE HAZELTON

## MULTI TESTER RANGES

AC Volt ..... 0-1500  
DC Volt ..... 0-1500  
DC Mills ..... 0-150  
Resistance 0-300,000

**\$11.75**



## ELECTRONIC MEASUREMENTS VOLOMETERS



101A METER **\$17.50** NET  
3" Model 101B  
OPEN FACE 4" METER **\$20.95** NET  
OPEN FACE PORTABLE  
101AP 3" Meter ..... \$21.50 net  
101BP 4" Meter ..... \$24.95 net

## —LATEST— STAR MEASUREMENT TUBE TESTER

Quick operation—with Rotary Selector and lever switches tests all tubes up to 117 volts. Also tests individual sections such as diodes, triodes, pentodes, etc.



**\$29.95** NET

## RECORD CHANGERS

WEBSTER 56—Automatic Stop ..... \$26.66  
DETROLA ..... 14.50  
SEEBURG—2 Post. .... 22.95

RCA CRYSTAL MIKE with table stand ..... **\$4.95**

12" P.M. SPEAKER 20 OZ. ALNICO MAGNET **7.75** NET

1L6 Push Pull or Push Pull Parallel 50 watt. Completely shielded. 250 mill primary 5000 ohms—sec. 2-4-8-15-500 ohms. H-57—Special Lim. Quan. .... **\$5.19**

## PHONO MOTOR and PICKUP KIT

SPECIAL **\$4.35**

Complete

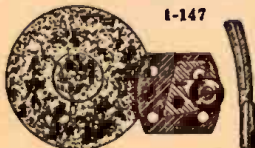

Crystal pick-up—Top quality constant speed motor. Motor Assembly only. \$3.95 and 25% deposit with order—balance Express Collect. Orders under \$5.00 send check or money order plus postage.

**LEONARD RADIO INC.**  
9 CORTLANDT ST.  
NEW YORK 7, N.Y.

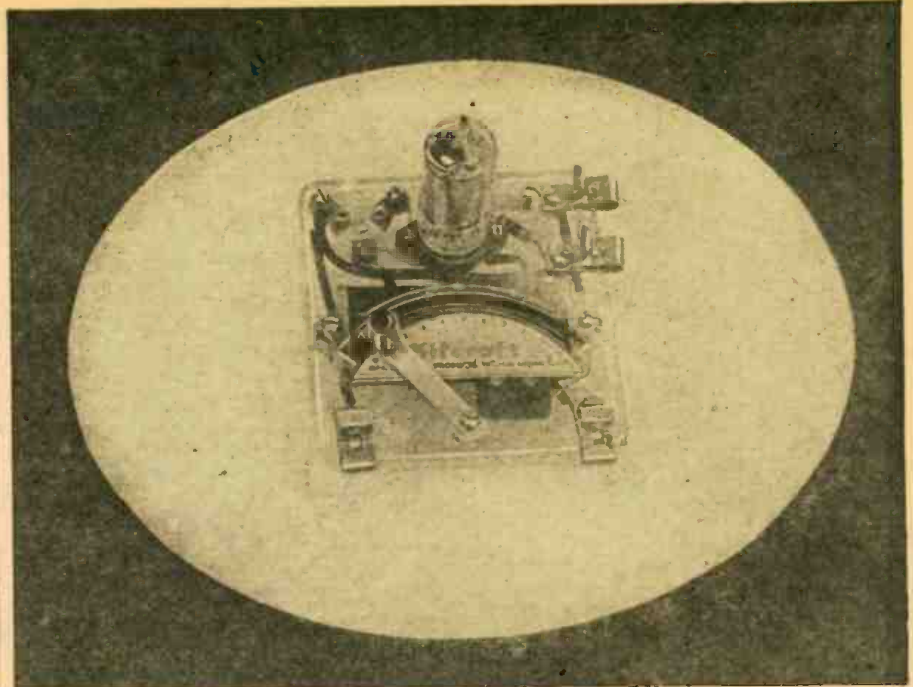

The Kitcraft radio is slider-tuned, like many crystal sets. Good headphones should be used.

# A MODERN 1-TUBER

By HARRY WINFIELD

A NUMBER of crystal receivers were described in the July issue. For the beginner in radio who desires something better than a crystal, the 1-tube kit set illustrated in the photo is the logical next step. No regeneration is used. Thus interference with neighboring receivers is eliminated. A 1L4 or 1T4 tube is employed, together with a 1.5-volt A-battery (flashlight cell) and a B-battery of 22.5 to 90 volts. The higher the B-voltage used, the greater the amplification and the stronger the signal.

in series with the control grid of the tube, and a grid leak of 3 megohms connects to ground. The screen grid of the tube is connected to B-plus; pins 4 and 5 are not used.

An aerial 100 to 150 feet long is suitable for use with this set, plus a good ground connection. The headphones should be of good quality, at least 2,000 ohms resistance.

The plastic base measures 3 1/4 x 3 1/4 inches and the height of the set with the tube in place is 2 inches.

## INSTRUMENT PICKUPS

An efficient vibration-type pickup for wooden musical instruments can be made from a set of high-impedance headphones and a length of shielded microphone cable. Wire the phones in series and connect them to the cable. One phone is to be placed on top of the instrument and the other on the back. Regular surplus Army-type headphones are ideal for the purpose. They have heavy spring-steel headbands which will hold the pickup firmly to the surface of an instrument such as a guitar. This type of pickup is easily removed. Select phones with rubber ear cushions as these prevent annoying rattle between the phones and the instrument.

A. L. SKALICKY,  
Mangum, Okla.

(Headphone units have been used as string pickups on a guitar. Diaphragms are removed and the magnets placed directly under the strings. A screw adjustment moves them toward or from the strings. See also article on page 62.—Editor)

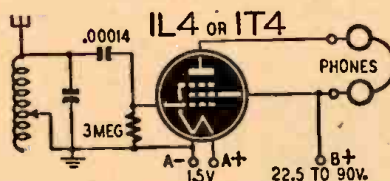

Fig. 1—The circuit could hardly be simpler.

The set is tuned by moving a slider across the tuning coil, the insulation being scraped from the wire along the path followed by the slider.

The base is of transparent plastic. Spring binding posts are provided for the aerial and ground connections, as well as the headphone cord tips. A 3-pin plug fits into a jack on the panel. Three colored wires lead from the jack plug: one for the B-plus, one for the A-plus, and the third wire for connection to A- and B-minus.

Fig. 1 is the schematic of the receiver.

A fixed condenser of suitable capacity is connected across the tuning coil. A second fixed condenser of 0.00014  $\mu$ f is

**NOW AVAILABLE FOR IMMEDIATE SHIPMENT!**

*The New Model*

# 777

**20,000 OHMS PER VOLT!!**

## SET TESTER



### *Specifications:*

- Tests all tubes including 4, 5, 6, 7, 7L, Octals, Loctals, Television, Magic Eye, Thyratrons, Single Ended, Floating Filament, Mercury Vapor Rectifiers, New Miniatures, etc. Also Pilot Lights.
- Tests by the well-established emission method for tube quality, directly read on the scale of the meter.
- Tests leakages and shorts of any one element against all elements in all tubes.
- Tests both plates in rectifiers.
- Tests individual sections such as diodes, triodes, pentodes, etc., in multi-purpose tubes.
- New type line voltage adjuster.
- **D. C. VOLTS:** (At 20,000 Ohms Per Volt)  
0 to 7.5/15/75/150/750/1,500 Volts
- **A. C. VOLTS:** (At 10,000 Ohms Per Volt)  
0 to 15/30/150/300/1,500/3,000 Volts
- **D. C. CURRENT:**  
0 to 1.5/15/150 Ma. 0 to 1.5 Amperes
- **RESISTANCE**  
0 to 2,000/20,000/200,000 Ohms 0 to 50 Megohms
- **DECIBELS!** (Based on zero decibels equals .006 Watts into a 500-Ohm line.)  
-10 to + 18 D.B., + 10 to + 38 D.B., + 30 to + 58 D.B.)

A super-sensitive, complete all purpose testing laboratory, this versatile analyzer will quickly and accurately test all tubes. The extremely high sensitivity of the V.O.M. section (20,000 ohms per volt on D.C. and 10,000 ohms per volt on A.C.) will enable you to:

1. Measure A.V.C. Voltages at the grid return of tubes.
2. Measure plate or grid Voltages in resistance coupled amplifiers.
3. Measure grid driving Voltages in amplifiers and phase inverters.
4. Measure minute leakage Voltages and currents in R.C. amplifiers.
5. Measure diode rectifier Voltages in second detectors.
6. Measure squelch Voltage in noise reduction circuits.
7. Align discriminator in F.M. sets.
8. Analyze automatic frequency control circuits.
9. Align F.M. receivers by measuring the grid voltage in the limiter stage.
10. Measure the Voltage at the grid of picture tubes for proper television alignment.

Model 777 operates on 90-120 Volts 60 cycles A.C. Housed in beautiful hand-rubbed cabinet. Complete with test leads, tubes charts and detailed operating instructions. Size 13" x 12½" x 6".

**\$ 59<sup>95</sup>**  
**NET PRICE**

20% DEPOSIT REQUIRED ON ALL C.O.D. ORDERS

## **GENERAL ELECTRONIC DISTRIBUTING CO.**

DEPT. RC-12 98 PARK PLACE, NEW YORK 7, N. Y.

RADIO-CRAFT for DECEMBER, 1947

43

# New

# RADIO-ELECTRONIC DEVICES

## OSCILLOSCOPE

Browning Laboratories, Inc.  
Winchester, Mass.

Model OL-15A, an omni-purpose 5-inch oscilloscope has been designed for those requiring versatility of operation, minimum weight and bulk, and faithful presentation of high harmonic content waves.

The response curve of the vertical amplifier is linear and without positive



slope from 10 cycles to 4 megacycles. The transient response is such that a 100-kc square wave which rises or falls in the order of 500 volts per microsecond is faithfully reproduced. The horizontal amplifier response extends linearly from 10 cycles to 1 megacycle to accommodate any type of externally generated sweep voltage which one may wish to employ. The sawtooth sweep range is from 5 cycles to 500 kilocycles with synchronizing sensitivity permitting synching and viewing 10 mc r.f. sine waves.

Triggered sweeps of 0.2, 0.5, 1, 5, 20, and 200 microseconds per inch may be inaugurated by the internal trigger generator or by external pulses. Sweeps and internally generated trigger are phaseable to each other so the sweeps may be adjusted to occur previous to or following the output triggers by varying degrees. Connections to all cathode-ray tube control elements are brought out the front panel to permit direct connection.

The total weight of the instrument including self-contained power supply is 95 pounds. The unit has a black wrinkle-finished cabinet and aluminum panel finished in black leatherette enamel with labels engraved directly into the aluminum. A cast aluminum bezel mounted over the cathode-ray tube screen assists in preventing glare and provides convenient means of changing ruled masks, color filters, and viewing aids.—RADIO-CRAFT

## SOLDERING AID

Nelpin Mfg. Co.  
Long Island City, N. Y.

The Solder-Matic is a new device that clamps on any standard soldering iron and feeds solder smoothly at the touch of a fingertip.

Solder in short lengths, in small coils, or fed from a spool as large as 25



pounds, can be handled. It takes solder from 1/16 to 3/16 inch in diameter, and feeds up to 3/16 inch per stroke. Screw adjustment of the stainless steel nozzle guides solder where needed, regardless of the size or shape of the particular soldering tip being used.—RADIO-CRAFT

## SENSITIVE RELAY

Sigma Instruments, Inc.  
Boston, Mass.

The Series 41 relay is designed for use with mercury thermostats and other small switches where contact current must be kept at about 4 ma or below

when used on 115 volts a.c. One model operates with only 2 ma at 115 volts a.c. in the coil circuit. Relay contacts are suitable for operating solenoid valves,

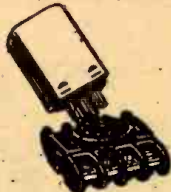

Indicator lamps, and resistance heaters.

Replacement is made easy by plug-in mountings. The Type 41RO weighs 3 ounces and is 1 1/2 inches square and 2 inches high above the base. This unit in combination with the new industrial octal socket permits screw connections to the relay.—RADIO-CRAFT

## INDUSTRIAL TUBE SOCKET

American Phenolic Corp.  
Chicago, Ill.

Direct mounting of metal industrial tubes, similar to the 172 thyratron, to noninsulated surfaces is facilitated by a compact steatite mounting bracket, available with or without feed-through bushings which permit wiring back of supporting panel.

Terminal screw sizes of 3/16 or 1/4 inch

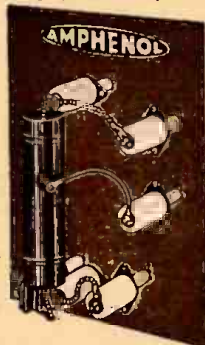

are available. Additional insulators may be used as tie points or feed-through insulators for the tube element connections. Surface electrical creepage distances are held at about 2 inches, enabling use at high voltages. Exterior of standoff is glazed and metal parts are plated.—RADIO-CRAFT

## NEON-GLOW VOLT-METER

Industrial Devices, Inc.  
Edgewater, N. J.

The Mini-Volt is a simple meter of practical accuracy calibrated for use on a.c. from 65 to 660 volts with an impedance of approximately 1/2 megohm. It is virtually burnout-proof and is operated by turning the knob until the glow extinguishes. The voltage is read directly off the scale. For d.c., which is indicated when only one electrode glows, the reading is multiplied by 1.15.

The meter is equipped with 12-inch test leads and is housed in a bakelite case that may be carried in the pocket or tool box without danger of damage. It is useful in checking fuses, line voltages, and radio plate voltages. The neon indicator is guaranteed for 10,000 hours of actual operation.—RADIO-CRAFT

## MIDGET SIG. GEN.

Clippard Instrument Laboratory, Inc., Cincinnati, Ohio

The Signalette is a pocket-size signal generator producing r.f., i.f., and a.f. signals simultaneously from approximately 2,500 cycles through 20 mc. The instrument works on 115 volts a.c. or d.c. When a.c. is used, modulation is

supplied at the line frequency. Modulation is not present when used on d.c. lines. It performs all the necessary functions of conventional signal generators.

The unit is approximately 9/4 inches long and 1 1/2 inches in diameter. It has an adjustable attenuator and is iso-



lated from the power source so it can be used safely with a.c.-d.c. receivers.—RADIO-CRAFT

## CHASSIS RACK

JFD Mfg. Co., Inc.  
Brooklyn, N. Y.

The "Repairack" is an all-purpose, cast aluminum radio chassis and phonograph turntable holder, useful to servicemen for assembling and repairing radios or phonographs. With this stand

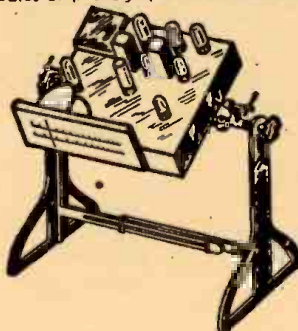

it is possible to rotate the chassis through 360 degrees in a horizontal plane, making it unnecessary to remove the set until the job is completed. The unit is sturdily made to hold the heaviest chassis and phono turntables.—RADIO-CRAFT

## REPLACEMENT SPEAKERS

Utah Radio Products  
Huntington, Ind.

Known as Models SESS6, SE6S6, and SE7S6, three new auto radio replacement electrodynamic speakers are



available in sizes of 5, 6, and 7 inches. Each model uses a 3-ohm voice coil and a 4-ohm field coil. Speaker mountings are square type. These new speakers supplement a wide line of Utah speakers now being produced in all required sizes and types.—RADIO-CRAFT

## R. F. POWER TRANSFORMER

Electronic Engineering Service  
Ridgewood, N. J.

A line of r.f. power supply transformers designed for use in television



receivers, cathode-ray oscilloscopes, and other equipment requiring an entirely safe low-current, high-voltage

source of power has been announced. Sizes available are: 1, 2.5, 4, 5, and 10 kv. All are conservatively rated at 250 microamperes, and each includes primary, secondary, feedback, and rectifier filament windings. All coils are Q-Max treated. A complete circuit diagram is included with each coil.—RADIO-CRAFT

## PHOTOELECTRIC RELAY

General Electric Co.  
Schenectady, N. Y.

A new photoelectric relay and light source operating on the modulated light principle has been announced. When operated at distances up to 1,000 feet, this equipment has sufficient sensitivity to prevent false operation due to rain, fog, or snowfall. Applications include traffic control, counting and limiting, and protection of restricted locations.

The light source contains a lamp, transformer, and motor-driven slotted disc which interrupts, or modulates, the light beam at about 900 cycles per second. The photo-electric relay has a tuned circuit which allows the relay to be responsive only to a light beam modulated at this frequency. It is not

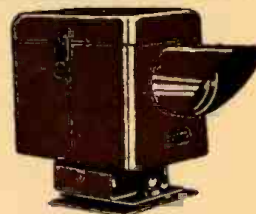

sensitive to changes in natural or artificial illumination. The light source has an infra-red filter which removes most of the visible light from the beam.

The units are mounted in outdoor enclosures which are thoroughly weather proof and are equipped with a universal mounting.—RADIO-CRAFT

## FM RECEIVER KIT

Radio Kits, Inc.  
New York, N. Y.

The Model FM-7 is a completely self-contained, 6-tube, table model FM receiver with a 86- to 110-mc tuning range. Provision is made for using the set as a tuner with a high-quality audio amplifier or for feeding its output into an extra speaker.

The kit comes complete with a bakelite cabinet, factory-tuned r.f. section, 2 i.f. stages, 1 limiter, discriminator, a.f. amplifier, and 6 miniature tubes.—RADIO-CRAFT

## CO-AXIAL RELAY

Advance Electric & Relay Co.  
Los Angeles, Calif.

The Series 7200 a.c. and 8200 d.c. relays are designed for s.p.d.t. switching 50-ohm co-axial lines. The 1/4-inch con-

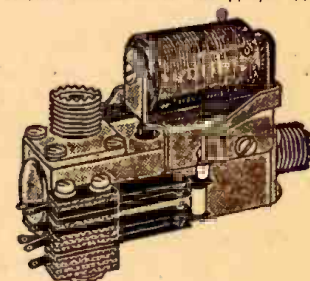

tacts are reached through an inspection port at the top. External 3/16-inch silver contacts are provided for simultaneous control of associated circuits.

The standing wave ratio is 1.02 when RG-8U co-axial is used. Amphenol connectors are provided for this cable.—RADIO-CRAFT

# NEVER!..NO, NEVER!

NOT IN ALL THE HISTORY OF RADIO, AN OFFER LIKE THIS!

Belltone  
**PORTABLE**  
Self-powered Battery Radio

# KIT

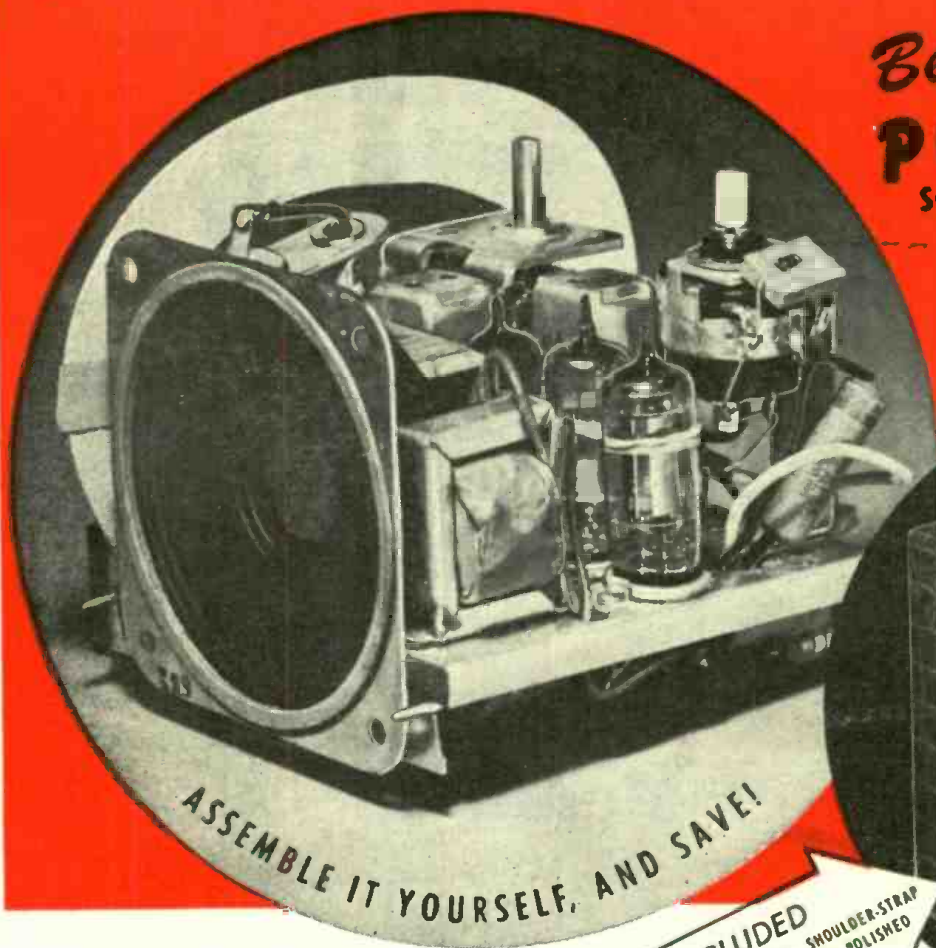

ASSEMBLE IT YOURSELF, AND SAVE!



BELLTONE GIVES YOU PLENTY OF SIMPLIFIED DIAGRAMS AND INSTRUCTIONS!

You get the Case, Knobs, Antenna, Tubes

## EVERYTHING!...

(EXCEPT WIRE, SOLDER, BATTERIES)  
1 Set of Batteries at only \$2.55

We urge you to bear in mind that this is NOT, definitely NOT, an ordinary portable, but a tiny, wonderful, beautiful, powerful set—which you can easily build yourself—quickly. Wait till you see the attractive case, covered in simulated leather, with adjustable shoulder strap. You'll want several. Use them as gifts.

**INCLUDED**  
THIS BEAUTIFUL, SHOULDER-STRAP  
CARRYING CASE WITH POLISHED  
BRASS FITTINGS.

**IT'S TINY**  
8 1/2" HIGH BY 4 1/2" WIDE  
BY 4 1/2" DEEP. THAT'S ALL!

HERE'S WHY THE SET IS SO EXTRAORDINARY AT THE PRICE!

It has a 3 1/2" ALNICO V PM speaker. Uses standard, easy-to-get, long-lasting batteries—easy to change. It plays with the lid open or closed. Has 4 tubes. Weighs 3 1/2" lbs. (approx.) when complete and operating, case and all!

*only*  
**\$14<sup>95</sup>-**

WE PAY THE POSTAGE ANYWHERE IN THE U.S.A.

USE THIS ORDER COUPON NOW! START BUILDING YOUR SET RIGHT AWAY!

**BELLTONE RADIO & TELEVISION CORP. DEPT. D**  
583 Ave. of Americas New York 11, N. Y.

Sirs: Send me \_\_\_\_\_ portable kits for which I am enclosing  MONEY ORDER  CHECK for \$ \_\_\_\_\_  
 Battery Kit @ \$2.55

SEND TO \_\_\_\_\_  
ADDRESS \_\_\_\_\_  
CITY \_\_\_\_\_ STATE \_\_\_\_\_

**BELLTONE** RADIO AND TELEVISION CORP.  
583 AVE. OF AMERICAS, NEW YORK 11, N. Y.

# BIG MONEY IN RADIO SEE THESE BRAND NEW RADIO BOOKS FREE

## COYNE'S *New 3 Volume Set* "APPLIED PRACTICAL RADIO"

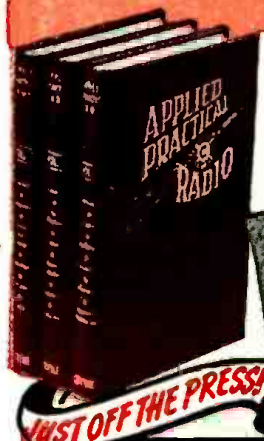

You men who want to go places in Radio, and who know how much a solid working knowledge of the field helps to get the big money—this is IT! Nearly 1,000 pages of down-to-earth Radio, from simplest principles to newest television! It's all there easy to understand—how and why it works . . . how to construct, install, service. PA, short-wave, auto-radio, aviation, radio-phonographs, FM—you name it, COYNE'S got it, in "Applied Practical Radio"!

**SEE IT FREE FOR 7 DAYS**

### PRACTICAL! CLEAR! COMPLETE!

3 big volumes—600 illustrations and diagrams, with step-by-step photographs which "break down" the equipment for you to show what makes it "tick." Up-to-the-minute, complete, easy to follow . . . written as only COYNE books are written!

**GET THIS BOOK FREE for LOOKING AT SET**



**Brand New! Explains circuits of latest sets.**

**VALUABLE BOOK FREE for Looking at 3 Volume Set**

*Send This Coupon*

You must SEE these books to know how easy it is to prepare for the big jobs in radio. Here's our special offer:—we'll send the complete 3-volume set for your 7 Day FREE Examination. And with it, we'll include our valuable, new guide for all radiomen, "150 New Radio Diagrams Explained," absolutely FREE! If you keep the 3-volume Set all you have to pay is \$3.00 within 7 days after the books arrive and \$3.00 per month until \$10.75 is paid—or you can pay \$9.75 cash price. If you don't want the set, return it and you OWE NOTHING. But either way you keep the "150 Radio Diagrams Book" as a gift. That book is ABSOLUTELY FREE.

**SEND NO MONEY** REMEMBER—COUPON IS NOT AN ORDER, just a request to see set free and get the FREE BOOK. But offer is limited, so act at once!

**EDUCATIONAL BOOK PUBLISHING DIVISION  
COYNE ELECTRICAL & RADIO SCHOOL,  
DEPT. 97-T1, 500 S. Paulina St., Chicago 12, Ill.**

O.K., send me, postpaid, your new 3-volume set, "Applied Practical Radio," on 7 Days Free Trial per your offer in Radio-Craft. Be sure to include as a gift the book of 150 New Radio Diagrams Explained, absolutely FREE.

**BOOK**

NAME.....AGE.....  
ADDRESS.....  
TOWN.....ZONE.....STATE.....

**COYNE ELECTRICAL & RADIO SCHOOL (Founded 1899)**  
500 S. Paulina St., Dept. 97-T1, Chicago 12, Ill.

## An Aid to Meter Reading

By P. Hemardinquer

**M**OST of the test instruments used by servicemen and amateurs are designed for several uses. A single instrument may measure voltage, current, resistance, capacity and the decibel output of amplifiers. Several ranges may be provided for some or all of these uses.

To connect the circuits properly for each of these varied uses it is necessary to use one or more gang switches, sometimes accompanied by toggle switches or pushbuttons. In much European apparatus, changes from one use or one range to another are often made by means of tip-jacks into which the test leads are inserted. This complexity of controls slows down the operation of checking a receiver, besides risking damage to the meter through wrong settings.

The simple device shown here speeds

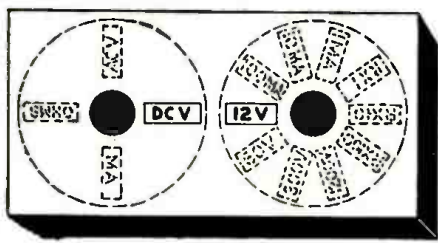

Fig. 1—All but desired figures are masked.

up service work and makes errors due to wrong instrument settings almost impossible.

The method is simplicity itself. For the ordinary type of gang switch, a disc of bakelite or other plastic is made, on which are inked in or engraved the indications usually inscribed on the panel. This disc must fit tightly on the shaft, and may be further secured to it by coil cement. If two multiple switches are used—as in many instruments—the disc diameter should be such that the two discs just clear, as shown in Fig. 1.

Next a cover large enough to fit over both discs is made of thin opaque plastic or electrical fibre. A window or windows are cut in the cover, as well as holes for the switch shafts. Narrow strips of plastic material, thick enough to keep the cover clear of the discs, are cemented around the edges. Now when the knobs are put on, we have an instrument with all indications but the correct ones hidden from sight.

Now the operator's whole attention is fixed on the correct indications, and mistakes are unlikely.

The same method can be used in equipment furnished with pins and jacks, especially in apparatus constructed with the system in mind. The jacks can be lined up as in Fig. 2 and

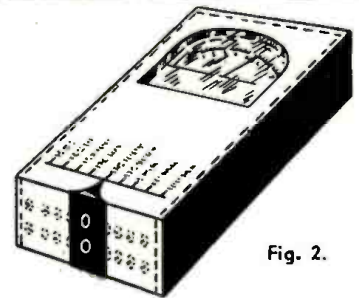

Fig. 2.

a protective cover placed over them. The cover has two openings directly over the jacks to be used, and may be held in place by another pair of pins which can be inserted in adjacent jacks.

### SPEAKER CLEANING KINK

My solution to the bothersome problem of removing metal particles from between the voice coil and pole of a dynamic speaker is simple and effective. Insert a long screw driver into a coil of insulated wire. I use a 6-volt speaker field, and energize it with direct current. This makes a powerful electromagnet that can reach into close places. Run the end of the magnetized screw driver around the opening between the voice coil and the pole, while gently moving the cone forward and backward. This removes magnetic metal filings. An air blast will remove non-magnetic material.

E. S. COLEMAN,  
Dallas, Texas



# RADIO MAINTENANCE

*Subscribers*

**AVERAGE**

**\$7800** income  
per year

Successful Radio Service Technicians read **RADIO MAINTENANCE** regularly. It is the magazine of ideas and information for profitable service shops. It helps maintain secure, high quality operation. Where you find **RADIO MAINTENANCE**, you'll find successful servicing!

Each month **RADIO MAINTENANCE** brings you the latest developments in television, radio and electronics by top experts in the field. Each article, each department is carefully edited and presented to help you in your daily work. All these articles are invaluable as reference material; and all the articles together will form a complete reference library on everything in the Radio Servicing business. In the coming year, **RADIO MAINTENANCE** will bring you a complete series on each of the following: AM—FM—Television—Signal Tracing and All Test Equipment—Low Cost Business Promotion Methods—Sales Techniques for Servicemen—How to Make Huge Profits in the Sound Installation Business. Each article in a series will be a compact unit in itself—combined with the others of its series, they form a complete education—a complete service library—to bring you prestige, profit and security in your own Radio Servicing establishment.

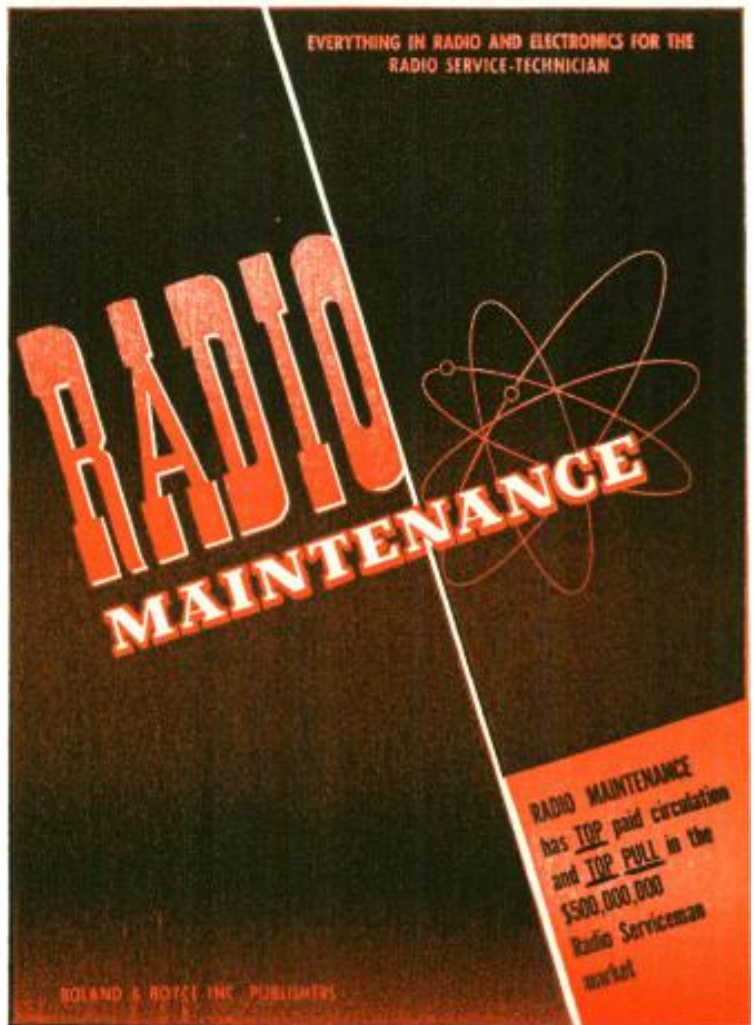

## AM SERIES

*There are still 70,000,000 AM sets to service*

Our principal source of income is servicing AM. The more sets we can get to service, the faster we can service each set, the more money we can make each week. **RADIO MAINTENANCE** rapid, trouble-free servicing techniques will enable you to triple your income. You will have more time to promote and build your business—for greater profit and security—present and future. Currently scheduled are 36 articles including suggestions for service shop design—portable racks for rapid movement of receivers without damage—ten-minute trouble location through simplified, modern signal tracing, circuit analysis and many other features. These **RADIO MAINTENANCE** articles will present a complete educational library on high profit AM radio service techniques.

## SOUND EQUIPMENT SERIES

Are you prepared to get your share of the huge profits in Sound? Sound installation brings thousands of dollars every year to the service technicians with the knowledge of how to handle sound. In every community, more and better PA systems are increasing in number, and you can get contracts immediately to equip auditoriums, dance-halls, restaurants, factories, and many other establishments. **RADIO MAINTENANCE** in the new, forthcoming series on sound will tell you how to sell PA, plan the installation, and pick the right equipment for the job. It will cover actual installation of all types of PA components, how to instruct the owners in operation and finally how to derive additional income from PA maintenance.

Every issue of **RADIO MAINTENANCE** contains information you want . . .  
Every day is **RADIO MAINTENANCE** day in your shop . . .  
Send in the coupon today—your first issue will be mailed to you immediately!

### RADIO MAINTENANCE MAGAZINE

460 Bloomfield Ave.  
Montclair 5, N. J.

Please send me **RADIO MAINTENANCE** FOR

- 1 year at \$3.00  
 2 years at \$5.00

check enclosed  bill me later

**BOLAND & BOYCE, INC., PUBLISHERS**

Name .....

Address .....

City-State .....

\*Occupation .....

Title (Service Mgr., etc.) .....

Employed by .....

\*Business or professional classifications are required to serve you better. Each subscriber will profit by writing one of the following classifications in space indicated.  
INDEPENDENT SERVICEMAN — DEALER SERVICEMAN — SERVICE MANAGER — DEALER — DISTRIBUTOR — JOBBER  
State your trade or occupation if not listed.

*Same  
day  
Service*

Meets *EVERY* Testing Requirement *BETTER*

# NEW model 3413 ...LEVER SWITCHING... tube tester

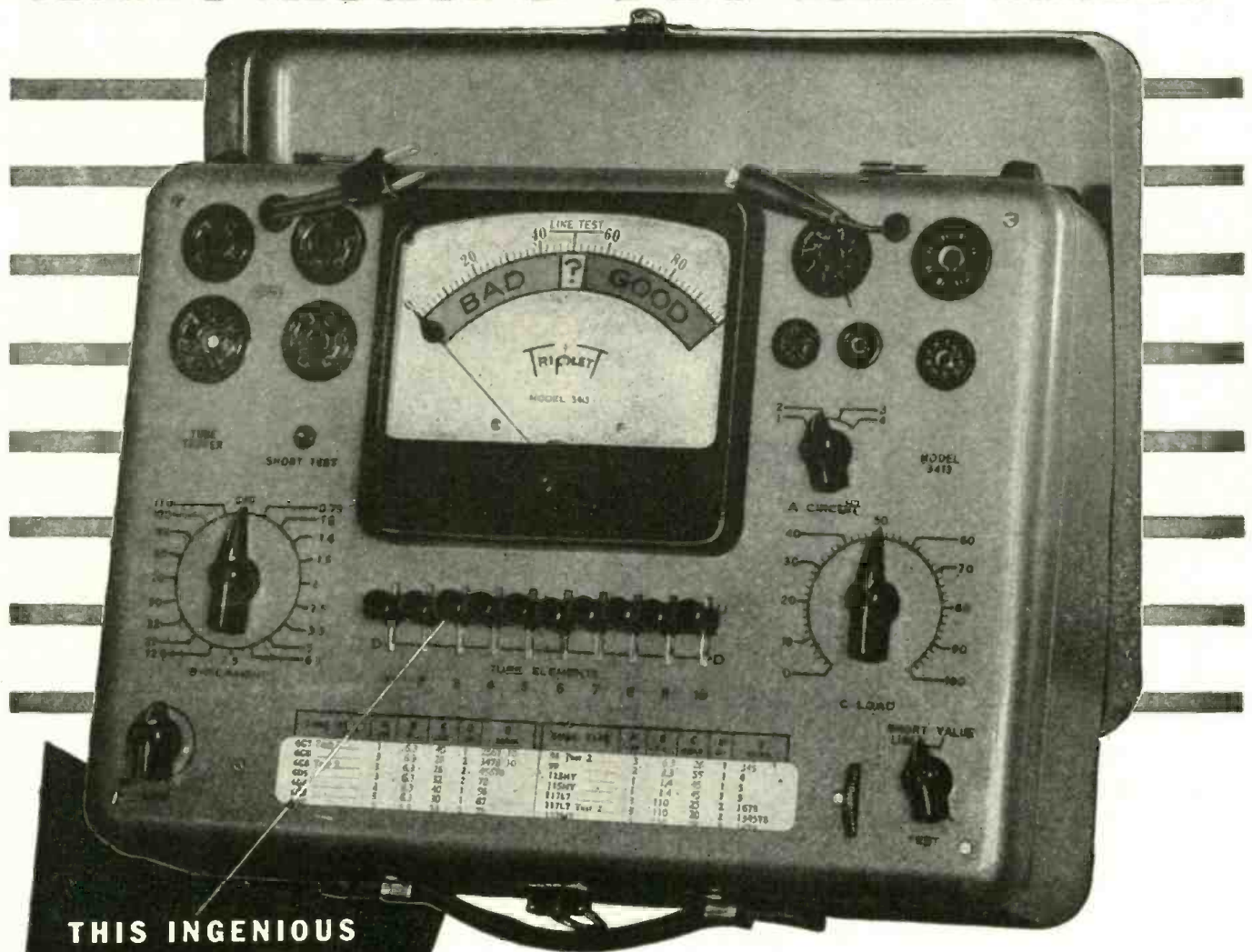

**THIS INGENUOUS  
LEVER SWITCHING**

*"Pictures your circuit"*

**FAST · SIMPLE · FLEXIBLE**

Provides individual  
control of each  
tube element

With the new Model 3413 you can make your settings instantly—just snap the switch up or down. You actually "picture" the circuit. Usually not more than five of the ten lever switches need be set, yet you have individual control of each tube element. Many other convenient features make Model 3413 the buy of its field—such as the handy, built-in SPEED-ROLL tube chart, the larger easy-reading meter, the handsome new case with streamlined design. For either counter or portable use you will find Model 3413 a quality-packed tester that you'll be proud to own. Write today. Address Dept. L-127.

*Precision first  
...to last*



# Triplet



**ELECTRICAL INSTRUMENT CO. BLUFFTON, OHIO**

RADIO-CRAFT for DECEMBER, 1947

# COMPARE Before You Buy Your Service Data

The speed with which you can complete radio repairs usually depends on the quality of your technical information service. That's why you owe it to yourself to choose the best. But don't guess. Don't take anyone's word for it. Be your own judge and jury.

Ask yourself: "Does the technical information service I use provide these features:

1. Is it *complete*—does it give me all the data I need to do the job?
2. Is the information *concise*, or is it padded with useless sales talk that makes needed data harder to find?
3. Is the data *uniform*—the same for all makes and models—or do I have to "dope out" a different layout for each model?

4. Does the data service give me *accurate* replacement listings—or do I have to guess what I should order from my parts distributor's stock?"

Don't guess about these important points. Compare PHOTOFACT Folders with any other service—point by point, set by set. Check specific models. See what PHOTOFACTS offer you— from complete disassembly instructions to exclusive Standard Notation schematics; from completely detailed drawings to exclusive exploded views. Then see what you find in others.

Be critical. Analyze carefully. Judge for yourself. Then you will know that *only* PHOTOFACT Folders will meet your actual needs.

*Howard W. Sams*

## Don't Miss PHOTOFACT Sets Nos. 23-28 with exclusive "Standard Notation" Schematics

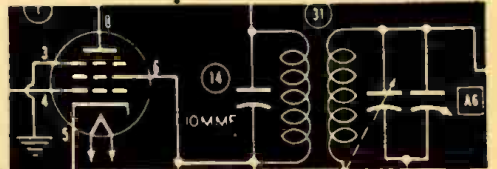

### Howard W. Sams 1947 Automatic Record Changer Manual

Nothing like it! COVERS MORE THAN 40 DIFFERENT POST-WAR MODELS. Absolutely *accurate, complete, authoritative*—based on actual study of the equipment. Shows exclusive "exploded" views, photos from all angles. Gives full change cycle data, information on adjustments, service hints and kinks, complete parts lists. Shows you how to overcome any kind of changer trouble. PLUS—for the first time—complete, accurate data on leading WIRE, RIBBON, TAPE, and PAPER DISC RECORDERS! 400 pages; hard cover; opens flat. Don't be without this manual. ONLY **\$4.95**



### Howard W. Sams Dial Cord Stringing Guide

There's only one *right* way to string a dial cord. And there's only *one* book that shows you how. It's the Howard W. Sams DIAL CORD STRINGING GUIDE. Here, for the first time, in *one* handy pocket-sized book, are all available dial cord diagrams and data covering 1938 through 1946 receivers. Licks the knottiest dial cord problem in a matter of minutes. This low-cost book is a "must" for servicing. You'll want one for your tool kit and one for your shop bench. Order today. ONLY **75c**

PHOTOFACT Sets now feature the exclusive new uniform "Standard Notation" schematics—the greatest service data development in 20 years! Every diagram is drawn to the same basic set of clear, uniform, easy-to-understand standards. Here's what the new "Standard Notation" Schematics mean to you: Makes circuit analysis simpler, quicker, fool-proof, more accurate! No more time wasted puzzling over odd-looking diagrams! No more trouble with varying symbols and confusing styles! Just ONE CLEAR STANDARDIZED STYLE FOR ALL CIRCUITS—SAVES YOU TIME—HELPS YOU EARN MORE. Subscribe to PHOTOFACT at your parts jobber now. At only \$1.50 per Set, it's the easy pay-as-you-earn way to build the world's finest service data library.

**BOOST YOUR EARNING POWER!**



### FREE! New PHOTOFACT Cumulative Index

New Cumulative Index to first 25 Sets of PHOTOFACT Folders now available! Your guide to more than 2200 receiver models and chassis (1946 and 1947 models). Ask your parts jobber for FREE copy, or write us direct.

**HOWARD W. SAMS & CO., INC.**  
INDIANAPOLIS 6, INDIANA

Export—Ad. Auriema—89 Broad St., New York 4, N. Y.—U. S. of America.  
Canada—A. C. Simmonds & Sons, 301 King St. East—Toronto, Ontario

**PHOTOFACT SERVICE**

"The Service that pays for itself over and over again"

Mail This Order Form to Your Parts Jobber Today or send directly to HOWARD W. SAMS & CO., INC., 2924 E. Washington St., Indianapolis 6, Ind.

My (check) (money order) for \$..... enclosed.

Send PHOTOFACT Sets  No. 23.  No. 24.  
 No. 25.  No. 26.  No. 27.  No. 28 (at \$1.50 per Set).

Send . . . SAMS' 1947 AUTOMATIC RECORD CHANGER MANUAL(S) at \$4.95 each.

Send . . . SAMS' DIAL CORD STRINGING GUIDE(S) at \$0.75 per copy.

Send PHOTOFACT Volume 1 (including Sets Nos. 1 through 10) in Deluxe Binder, \$18.39.

Send PHOTOFACT Volume 2 (including Sets Nos. 11 through 20) in Deluxe Binder, \$18.39.

Send FREE PHOTOFACT Cumulative Index.

Name.....

Address.....

City..... State.....

# THE TURNER MODEL U9S DYNAMIC

## TRANSATLANTIC NEWS

(Continued from page 39)

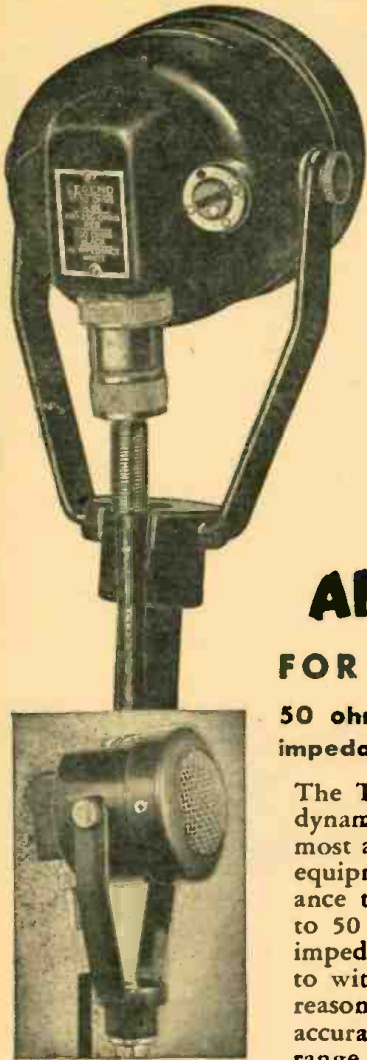

# ROUGH AND READY

## FOR A VARIETY OF JOBS

50 ohms, 200 ohms, 500 ohms, or high impedance at the TWIST OF A SWITCH

The Turner Model U9S is a professional dynamic adapted for all-around use with most any communications or sound system equipment. Built-in tapped multi-impedance transformer permits quick matching to 50 ohm, 200 ohm, 500 ohm, or high impedance inputs. The Model U9S is built to withstand heat, cold and humidity, and reasonably rough handling. Dependable and accurate at all impedances, its smooth, wide-range response make it highly desirable for both voice and music pickups. See and try the Turner Model U9S at your dealer.

### SPECIFICATIONS

**EFFECTIVE OUTPUT LEVEL:** 52 db below 1 volt/dyne/sq. cm. at high impedance.

**FREQUENCY RESPONSE:**  $\pm 5$  db from 40 to 9000 c. p. s.

**OUTPUT IMPEDANCE:** 50, 200, 500 ohms, high.

**DIRECTIONAL CHARACTERISTICS:** Semi- or non-directional when tilted back 90°.

**DIAPHRAGM:** Large, specially designed of aluminum. Special voice coil assembly to give high output.

**MAGNETIC CIRCUIT:** Heavy magnets, rugged construction.

**CASE:** Die-cast alloy.

**FINISH:** Baked gun-metal.

**MOUNTING:** 5/8" -27 standard coupler.

**CABLE:** 20 ft. removable balanced line cable set.

**DIMENSIONS:** 3 1/2" long x 5 1/2" high (with saddle) x 3" wide.

**WEIGHT:** 26 ounces.

TYPICAL  
FREQUENCY  
RESPONSE  
(HIGH IMPEDANCE)

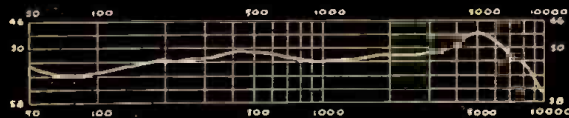

Microphones by **TURNER**

**THE TURNER COMPANY**

902 17th STREET N. E.

CEDAR RAPIDS, IOWA

tures. It is the work of John Sargrove, inventor of the ECME system of mass-producing radio sets by electronically controlled machinery. Sargrove holds that the production of tubes also needs simplification and proposes a single type for use throughout the receiver. His new tube is certainly original. Imagine a beam tetrode with beam-forming plates of E section. Slice the electrodes (except the cathode and the beam-forming plates) in two by a vertical section, and you have, as shown in the accompanying figure, 2 beam tetrodes in 1 bulb. The halves of the tube are screened from one another by the cathode and by the middle arms of the E's, which come very close to it. Further screening between the leads to the 2 sets of electrodes is provided in the glass "foot" into which the electrodes are sealed. The 2 halves of the tube having identical characteristics, may be used if desired in parallel or in push-pull; or each half of the tube may be used in a separate way for a special purpose. Either half (or both) can be made into a triode. No less than 3 kinds of triode are possible: (1) the anode is connected to the outer grid; (2) the two grids are connected together; (3) the outer grid is used as control grid the inner being connected to a slightly positive cathode. It is claimed that the tube can be used effectively as mixer-oscillator, i.f. amplifier, detector-amplifier, a.f. amplifier output, plain a.f. voltage amplifier, or power amplifier.

So far I have not had the opportunity of trying out these tubes; but the characteristics of the tube arranged for use in a variety of ways certainly seem to show considerable promise. It has one snag: the input-to-output capacitance is high. For this reason it is not likely to be useful in a really high-gain r.f. or i.f. stage with tuned input and output circuits. It may, though, answer well in the simpler broadcast receivers. It appears indeed possible that this, plus printed circuits, may be the answer to the problem of mass-producing low-priced domestic radio sets.

If the tube proves successful, it could be manufactured very cheaply, for long runs on a single type mean low production costs. Further, its highly original design means that the electrodes of the twin tubes in one bulb contain no more metal than would be required to construct a single tube of conventional pattern.

It will be curious if *the radio receivers of the future contain but one type of tube throughout*, for if this happens we shall have returned to the state of affairs prevailing in the early days. Then, as old hands will remember, we used the same kind of tube in every socket of the set, from input to output. We couldn't do anything else, for the high-impedance audion triode was the only tube available and it had to serve all purposes.

NOW... ANYONE  
 who owns ANY  
 RADIO can enjoy  
 thrilling FM with  
 the amazing  
**Pilotuner**

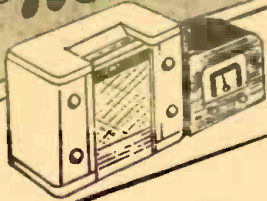

# GOLD MINE

for Radio Service Dealers

# FM *Pilotuner*

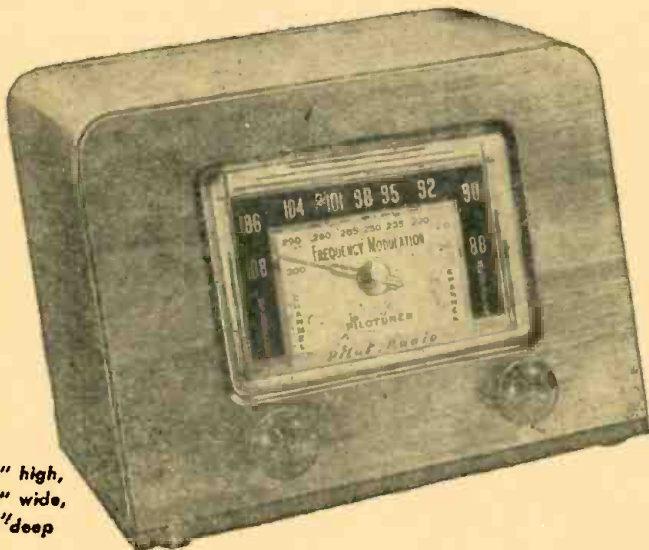

6 3/4" high,  
 8 3/4" wide,  
 5 3/4" deep

- Sell while you service! Enjoy bigger business and bigger profits with the amazing, new FM PILOTUNER that adds FM to any radio at all — yet retails for only \$29.95.
- Every service call is now a potential PILOTUNER sale for you! Demonstrate it — leave it in the home on trial. And watch the volume and profits roll in with the miracle unit that has set a new standard of superior FM performance!
- Yes... here is your golden opportunity, Mr. Radio Service Dealer! Join the growing number of alert service dealers who are placing reorders weekly for the PILOTUNER! Stock the FM PILOTUNER now — and start reaping extra dividends.

Write today for full details on the FM PILOTUNER!

**PILOT RADIO CORPORATION**, 37-06 36th ST., LONG ISLAND CITY, N. Y.  
 Makers of PILOTONE VINYLITE RECORDS • PIONEERS IN SHORT WAVE • FM • TELEVISION



**RADIO WAREHOUSE INC.**  
73 East Mill St., Akron, Ohio



Better get on our  
**MAILING LIST!**

If you haven't sent us  
your name and address,  
do it now and be

sure of getting  
our monthly  
**BARGAIN  
BULLETIN**

and all special  
Deals we offer

**NO CHARGE—  
IT'S FREE!**

CLIP THIS  
COUPON TODAY

**OLSON**

**RADIO WAREHOUSE INC.**  
73 E. Mill St., Dept. 106, Akron, O.

Sure, put me on your List.

I want to save time and money.

I have a Service Shop.

I am an Amateur or Experimenter.

NAME \_\_\_\_\_

ADDRESS \_\_\_\_\_

CITY \_\_\_\_\_ STATE \_\_\_\_\_

# New Radio-Electronic Patents

By I. QUEEN

## MICROWAVE HARMONIC GENERATOR

John W. Tiley, Philadelphia, Pa.  
(assigned to Philco Corp.)  
Patent No. 2,422,146

Cavity resonator tubes like the Klystron are generally used as oscillators or amplifiers. Such tubes can be used also as harmonic generators in properly adjusted circuits as disclosed here. The fundamental frequency input appears between grid and cathode (or external metal band

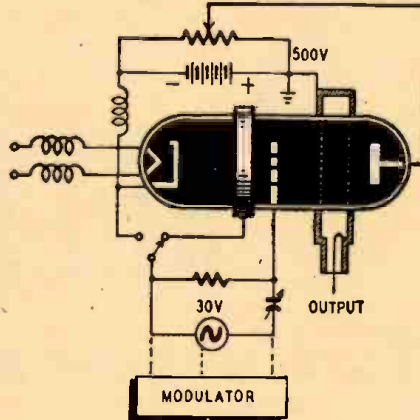

around the tube). The cavity is tuned to the desired harmonic. As an example, these frequencies may be 200 mc and 3000 mc, respectively. The harmonic is brought to maximum strength by adjusting the potential of the repeller. Too much feedback should be avoided, however, to prevent self-oscillation.

The input voltage may be either unmodulated or frequency modulated (as shown).

## DIRECTION FINDER

Wendell L. Carlson, Haddonfield, N. J.  
(assigned to Radio Corp. of America)  
Patent No. 2,419,987

In most types of direction finders a loop must be rotated until it points toward a transmitter for maximum signal response or away for minimum signal. In this improved direction finder, the loop does not have to be turned. Instead a visual indicator shows continuously whether the transmitter is located to the right or left of the receiver. This is especially convenient when either or both the transmitter or receiver are mobile.

The signal picked up by a loop is resonated by a series-tuned circuit and is amplified. The voltage from a vertical antenna is resonated by a parallel-tuned circuit. The signals are combined and applied to a suitable receiver. It is known that the sensitivity pattern of a loop is a figure eight. Reception is equally good from 2 opposite directions, but these signals are received out of phase. The vertical antenna has a circular pattern.

The indicating meter has 2 coils, M1 which is fixed and M2 which is pivoted. M1 is actuated by a low-frequency oscillator. The a.c. component of the receiver output is connected across M2.

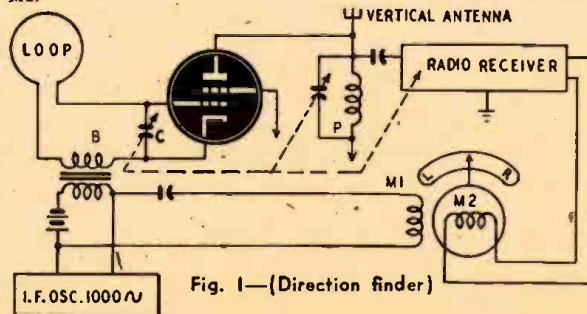

Fig. 1—(Direction finder)

Circuit theory shows that the voltage appearing across C is 90 degrees out of phase with the voltage across P, when both tuned circuits are resonated. If the series circuit is mistuned, the angle becomes greater or less than 90 degrees, according to which side of resonance it is tuned. Actually this circuit is wobbled by a low-frequency oscillator which varies the inductance value of B 1,000 times a second.

Vector diagrams can be used to show how the circuit operates. If a transmitter is located at D in Fig. 2-a, the loop picks up no signal. Since the vertical antenna pickup is constant, there is no a.c. component across M2. The a.c. voltage across M1 produces an a.c. torque whose average is zero. Therefore the needle remains at midscale. Now if a signal originates at E, the loop intercepts it. The voltage across C varies periodically between L1 and L2 in Fig. 2-b. The vector A is the vertical antenna pickup. The vector sum of the signals varies periodically between R1 and R2. This a.c. component excites the meter coil M2. The voltage across C exists at the same instant as the torque to the left from coil M1. R2 is synchronized with a torque to the right. Since R2 is larger, the needle deflects to the right in this case. If the transmitter is located within the other lobe of the loop pattern, as at point F, the loop voltage is reversed. The vector diagram of Fig. 2-c now applies. R1 is now larger than R2, and since R1 still corresponds to a torque to the left, the needle moves to the left.

## DISTANCE INDICATOR

Patent No. 2,422,382  
Henry T. Winchel, N. Hollywood, Calif.  
(assigned to Bendix Aviation Corporation)

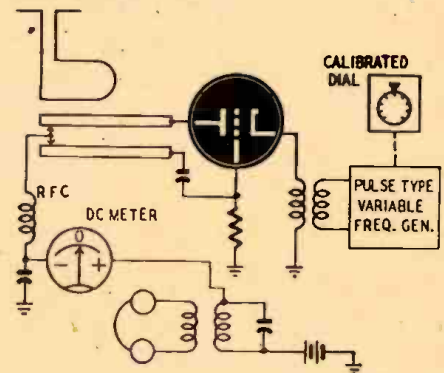

A patent has been issued for a superregenerator used for measuring distances to a target. Such a circuit becomes a transmitter as well as a receiver when it is closely coupled to an antenna system.

A pulsed variable-frequency oscillator periodically quenches or damps the oscillations of the superregenerator. The pulsed r.f. power is radi-

(Continued on page 70)

## SENSITIVITY PATTERN

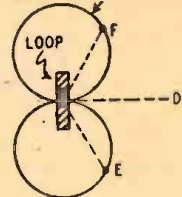

Fig. 2-a



Fig. 2-b



Fig. 2-c

**Prepare  
NOW**

for a Better Job *in*  
*the Field of Radio!*

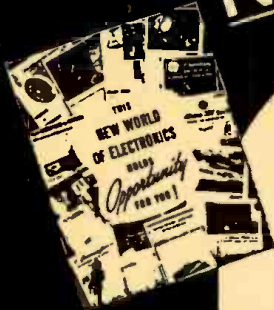

**Don't Delay—  
Write Today!**

**Greater Knowledge means Greater Opportunities!**

Yes, Mr. Radioman, there are innumerable more and better jobs in the Field of Radio as a result of war-developed techniques—Mobile Communications Systems for Automobiles, Busses, Trains, many Industrial Applications, Micro-Wave Relay Systems, FM Broadcasting, Television—these are just a few of the many new opportunities open to you who are alert—and are qualified!

**Let Cleveland Institute Take Over Your Personal Up-Grading Problem!** Qualified, competent instructors, ample personalized instructional aids, orderly, progressively arranged study assignments in recognized, approved technical texts—these are only a few of the many superior advantages of CIRE'S plan of personalized spare-time home study training for professional self-improvement.

**CLEVELAND INSTITUTE COURSES OFFER COMPLETE TECHNICAL TRAINING RANGING FROM LOW-LEVEL TO COLLEGE-LEVEL.**

- A. Master Course in Radio Communication. Covers complete preparation for broadcast station employment including preparation for FCC License Examinations.
- B. Advanced Course in Radio Communication Engineering. A college-level Radio Engineering Course.
- C. Specialized Television Engineering. Including post-war Television Techniques.

All Courses Include

The Remarkable Workbooks of Instructional Aids, prepared by the instructing staff of Cleveland Institute. Choose the course best suited to your needs—Start with the section you are qualified to enter—Use the economical CIRE "Pay-As-You-Go-Plan."

**ENROLL FOR INDIVIDUAL SECTIONS OF COURSES, IF YOU PREFER.**

If you need only highly specialized training, you can study one or more of the following sections instead of a complete course.

1. Mathematics of Radio.
2. Fundamentals of DC and AC Theory.
3. Essentials of Radio Communication.
4. Communication Networks.
5. Advanced Radio Telephony for the Broadcast Operator.
6. Audio and Radio Components and Systems (Design of Receiver and Transmitter Equipment).

**CLEVELAND INSTITUTE  
OF RADIO ELECTRONICS**

Contractors to the Canadian Broadcasting Corporation

**RC-12 Terminal Tower  
CLEVELAND 13, OHIO**

Approved for Training under "G-I Bill of Rights"

(MAIL THIS COUPON)

Cleveland Institute of Radio Electronics, RC-12, Terminal Tower, Cleveland 13, Ohio.  
Gentlemen: Please send information about your home courses in Radio Electronics.

NAME ..... I desire training in  A  B  C  
I have had experience in broadcasting  servicing   
ADDRESS ..... operating  mfg.  CAA  Army-Navy   
CITY ..... amateur  other ..... I am a  
High School Grad.  College  Degree .....  
ZONE ..... STATE .....  Check here for Veteran Enrollment Information.

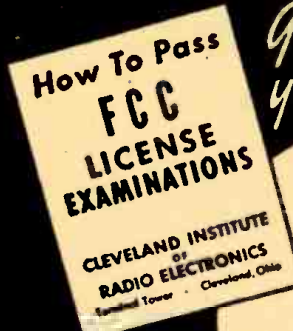

*Get your*

**FCC Commercial Radio Operators' LICENSE NOW!**

**Don't Delay—  
Write Today!**

**IT'S EASY IF YOU FOLLOW OUR PLAN!**

Thousands of new jobs are opening up—FM, TELEVISION, MOBILE COMMUNICATIONS SYSTEMS, are only a few of the radio fields which require licensed operators.

**TIME IS IMPORTANT TO YOU!**

You can get your License quickly with **NILSON'S MASTER COURSE in RADIO COMMUNICATION** and exclusive CIRE Workbooks of Instructional Aids. Saves you many hours of random, undirected study.

Assures a MINIMUM of time in getting your ticket.

**FREE BOOKLET** tells you the Government Requirements for all classes of commercial licenses—Sent immediately upon receipt of coupon.

Approved for Veteran Training under "G-I Bill of Rights"

**CLEVELAND INSTITUTE  
OF RADIO ELECTRONICS**

Contractors to the Canadian Broadcasting Corporation

**RC-12 Terminal Tower  
CLEVELAND 13, OHIO**

MAIL THIS COUPON

**CLEVELAND INSTITUTE OF RADIO ELECTRONICS**  
RC-12, Terminal Tower, Cleveland 13, Ohio  
Gentlemen: Please send information about your Home Study Course for preparation for FCC Commercial License Examinations. (Does not cover Amateur License Examinations.)

Name.....  
Address.....  
City..... Zone..... State.....  
 If a Veteran check here

# RADIO • ELECTRONIC CIRCUITS

## SCRATCH FILTER

This tuned scratch filter cuts record hiss considerably and reduces high-frequency distortion by lowering the cut-off limit. It reduces the volume level

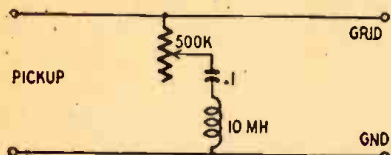

slightly but this can be remedied by boosting the volume. Adjust for different scratch levels with the 500,000-ohm control.

PAUL WEISENBACH, II,  
Cleveland, Ohio

## USEFUL AMPLIFIER

This amplifier is simple to construct and supplies ample output for use as a small PA system, instrument, or phono amplifier. It can be used as a high-power intercommunicator with the addition of suitable switches.

A 6SC7 connected as a resistance-coupled cascade amplifier drives push-pull 6V6's. The grids of both stages are connected to input jacks through volume controls. The first stage may be used for an instrument pickup and the second stage for a high-output crystal microphone.

The phase-inverter system is similar to that used in several oscilloscopes. As the signal voltage on the grid of T1, swings in a positive direction more plate current flows through the non-by-passed cathode resistor common to T1 and T2. As the plate current increases or decreases a corresponding voltage develops across the resistor to make the cathodes of both tubes vary in voltage with respect to ground. The grid of T2 is grounded and is more negative than its cathode, producing a plate current change of equal amplitude 180 degrees out of phase with the plate current of T1.

ALBERT ECKFELD,  
Portsmouth, Ohio

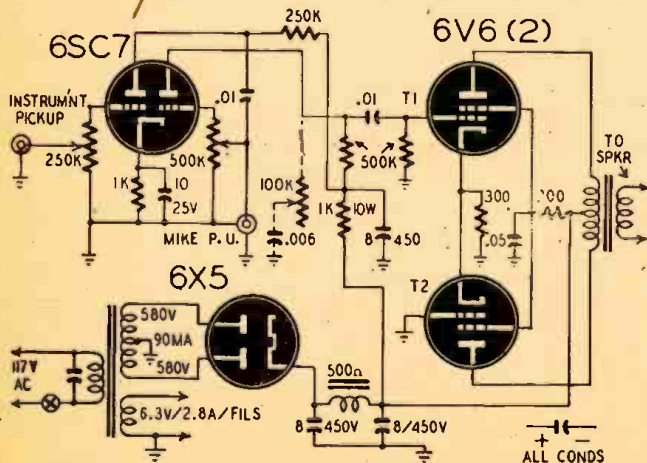

Readers have written us in almost equal numbers approving and condemning the new Radio-Electronic Circuits, gleaned from recent technical literature. This month we are printing a number of the old type. Which kind do you like best? Let us have your vote on this subject by return mail.

## CONDENSER CHECKERS

A number of condenser analyzers have been described which incorporate a neon leakage indicator as well as a capacity bridge. Usually, bridge balance is indicated by a cathode-ray indicator tube and leakage by flashes of the neon bulb. I find it possible to indicate leakage on the indicator tube also. A circuit is shown.

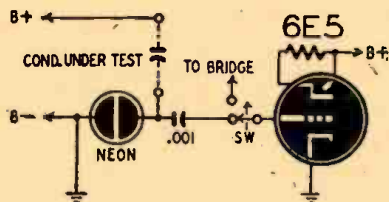

The condenser that usually by-passes the neon bulb is removed and connected between the high side of the bulb and the grid of the tube through a s.p.d.t. switch. When the 0.001- $\mu$ f condenser is charging and discharging through the neon bulb, the shadow of the tube opens and closes. It is possible to conceal the neon bulb and use the indicator tube for all measurements.

HAROLD R. NEWELL,  
Bradford, N. H.

## NOVEL OUTPUT METER

For some time I have been using an output meter that is ready for use without having to be hooked to the set under test. It consists of a 1-ma d.c. meter and rectifier connected in series with a magnetic speaker. Place this speaker face to face with the speaker

of the set under test, turn on the signal generator and align the set. A moderate signal will give a good indication on the meter. A PM speaker may be used,

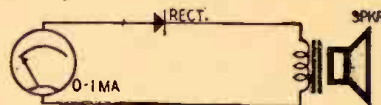

although I find that a magnetic speaker is more sensitive.

Time is saved with this output meter because it does not have to be attached to the set under test.

H. ACKERMAN,  
Brooklyn, N. Y.

(How will this system work in a shop with a high noise level or when several other receivers are going full blast? —Editor)

## NOVEL EXPANDER

This circuit uses variable volume expansion and inverse feedback, through the addition of a 100-turn coil L1, of No. 32 wire, wound over the secondary of the output transformer. This coil is tapped at 20, 40, and 80 turns and connected to a 6-point tap switch S2. The choke L2 in the 6J7 cathode circuit has 50 turns of No. 20 wire on a core 1/2-inch square. Larger wire may be used, as the object is to keep the d.c. resistance below 1 ohm.

With S1 closed, the expander is in the circuit. An increase in current in the voice-coil circuit will develop an increasingly large voltage across the pilot lamp, because the resistance increases with temperature. This voltage adds to the cathode bias to increase the gain of the 6J7. S2 controls the amount of expansion. S3 completes the feedback circuit with the amount of feedback controlled by the setting of the arm of the 6-ohm resistor.

Various types of radio pilot lamps can be tried for best results.

A. A. BOSSCHART,  
Amsterdam, Holland

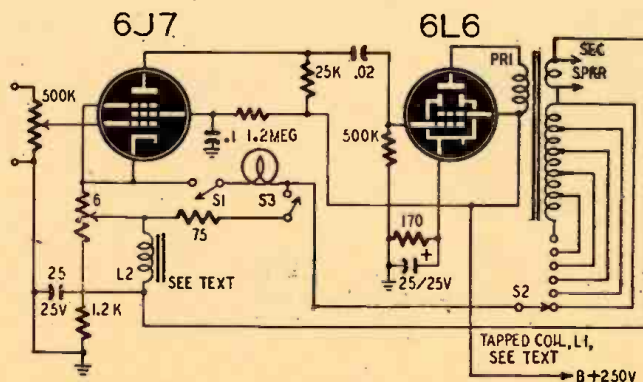

Left—Simple and adaptable audio amplifier circuit with 6V6 output. Above—This novel volume expander employs a low-voltage dial lamp.





**Stop!**

**IN BUYING RADIO PARTS**

**Demand This**

**SEAL of QUALITY**

**of America's Radio Storehouse**



**LOWEST PRICES**

**HIGHEST QUALITY**

**NO WAR SURPLUS**

**GENERATOR CONDENSERS**



PHILCO part No. 61-0177-5 mfd. — 2" x 1 1/2" — 4' lead-slotted mounting strap for easy installation—Standard Merchandise—not war surplus—Present list price \$1.00.  
Our special—over 83% off.....

**14c**

**OUTPUT TRANSFORMERS**

Clean stocks — long leads — mounting feet — made to fit where you need them.  
For 6F6-6K6 — to 4 ohm voice coil — size 2" x 1 1/2" x 1 3/4".  
50L6-35L6-25L6 to 4 ohm voice coil 1 3/4" x 1 1/2" x 1 3/4".  
Specify quantity of each type you need at.....



**49c**

**CATHODE CONDENSERS**



10 Mfd. at 25 working volts — 1 1/4" x 1 1/4" tubular type — aluminum cans — overall cardboard sleeve — tinned leads — quality construction by a national manufacturer — backed by the famous R. S. & E. guarantee — list price 78c. Priced to make you money at! 12c each lots of 10 for.....

**108 for 900**

**MIDGET I. F. TRANSFORMERS**



100-500 Kc range — 1 1/2" square x 2 1/2" high — ceramic based mica trimmers — high gain iron cores — pep up old receivers — ideal for new construction. List price \$2.10 — up to 88% discount — stock up now for future use.

Each **29c** Dozen **339** Hundred **2500**

**AEROVOX GL 8-600**



Genuine Aerovox 8 mfd. — 600 volt working — inverted screw mounting — aluminum can 1 3/4 x 1 1/2" — 8" insulated leads. List Price \$4.00 — quantity limited — order now on this one time item at only.....

**99c**

**MODEL 451A**

**AC-DC Volt - Ohm - Milliammeter**



A dependable instrument of wide utility — sensitivity 1000 ohms per volt.  
Ranges: Volts AC, DC, and Output Ranges.  
0-10/50/100/500/1000;  
Ohms full scale, 500,000.  
Ohms center scale, 7200.

NET complete with batteries.....

**1490**

**MODEL 312**

**Volt - Ohm - Milliammeter**

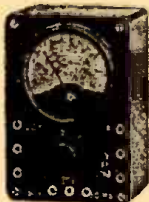

An economy pocket meter featuring a 2" moving vane meter.  
Reads: AC-DC volts, 0-25/50/125/250;  
Mills AC-DC, 0-50;  
Ohms, 100,000;  
mfd., .05-15.  
Jaeka provide range selection.

NET complete with cord and plug.....

**675**

*Start Your Own*  
**RADIO SERVICE SHOP**

as low as **9950**

Complete Starting-In Business Stocks of  
**TEST EQUIPMENT, TUBES, PARTS, TOOLS, EVERYTHING**

Write, Wire, Phone for Full Details

**PHONO PICKUP CRYSTALS**

Standard types — Set Manufacturers close-out — all Guaranteed



Webster F2 — Replaces L26-L40-L70 etc. — pin type terminals — 1 oz. pressure — 1 volt output — 5000 cycle cut off.  
List price \$5.00 — you pay us.....

**149**



SHURE P93 — W57A — pin type terminals — 1/4 oz. pressure — 1.6 volt output — 6000 cycle cut off.  
List price \$4.46 — our Special.....

**198**



Astatic L-70 — new post war design — solder terminals — 1/4 oz. pressure — 1 volt output — 4000 cycle cutoff.  
List price \$5.35 — we quote you.....

**198**

**Pep-Up PHILCO CHANGERS**

At last! All the parts you need to restore brilliant tone and volume to "sick" changers! You'll need all three items — sell your customer a 100% reconditioning job — Selenium cell only, no holder..... **\$1.80**  
Sapphire needle only, no mirror..... **\$1.20**  
Special original equipment lamp..... **27c**  
RECONDITIONING KIT — all three above items — postpaid — special at..... **321**

**RADIO RULE**



Here is a clear 6" plastic rule — a necessity for radio students, draftsmen, hams, all who desire cleaner, more precise work — National advertised at \$2.00. Order yours today postpaid only..... **35c**

**SEND FOR FREE CATALOG**

**MULTI-RANGE MILLIAMMETERS**

Two types — for A.C. or D.C. measurements

**MODEL 671** — for A.C. current. Seven switch selected ranges of 0-5, 10, 25, 100, 250, 500, and 1000 milliamperes.  
**MODEL 675** — for D.C. current. Eight switch selected ranges of 0-1, 5, 10, 25, 100, 250, 500, and 1000 milliamperes.  
Here are two meters you can't afford to pass up — just the thing for radio servicing, transmitter trouble-shooting, general lab and experimental work.



A One-Time only Special buy at

**795**

**606B-VOLTAGE TESTER**



Checks voltage and polarity. Range: 0-440 AC-DC volts — definite indications for 115, 220, and 440 volt lines. Separate polarized vane for AC or DC indication. Built in test leads. Excellent for checking wiring, fuses, general factory installation and maintenance. Every plant — every electrician needs several at this low price. Regular net 16.67  
Special at..... **895**

**VOLTMETERS**



Panel meters by Triplet! Top quality instruments — new — boxed — five popular types — priced right — your chance to get those meters you've always wanted —

**MODEL 332** — 0-150 A.C. volts — 3" round flush mounting black brass case.  
**MODEL 231** — 0-150 A.C. volts — 2" round flush mounting bakelite case.  
**MODEL 237** — 0-150 A.C. volts — 2" square flush mounting bakelite case.  
**MODEL 221** — 0-30 D.C. volts 2" round flush mounting bakelite case.  
**MODEL 324** — 0-400 D.C. volts — 3" round projection mounting — bakelite case.  
Supply limited — order now — list models you desire. **295 EACH**

**RESISTANCE LINE CORDS**



Standard 3 terminal 135 ohm AC-DC cords — sturdy construction — flexible — 6 1/2' long — complete with plug — for sets having approximately 60-75.2 volts drop in the filaments — Regular list price 1.17 —

**Only 33c**

Include full remittance with orders of \$3.00 or less. Include 25% deposit with all C.O.D. orders of \$3.00 or more. All shipments sent express collect if postage is not included. Prices subject to change without notice.  
**BE SURE TO INCLUDE SUFFICIENT POSTAGE. EXCESS WILL BE REFUNDED.**

**RADIO SUPPLY & ENGINEERING CO., Inc.**

125 SELDEN AVE.

DETROIT 1, MICH.



SUPREME PUBLICATIONS

# New 1947 Radio DIAGRAM MANUAL

Only  
\$2.00

## Amazing Bargain Offer in Diagram Manuals

ALL NEW 1947 CIRCUITS—SERVICE DATA YOU NEED TO GET AHEAD

Be prepared to repair quickly all new 1947 sets. In this big single volume you have clearly-printed, large schematics, needed alignment data, replacement parts lists, voltage values, and information on stage gain, location of trimmers, and dial stringing, for almost all sets released between June 1, 1946, and March 1, 1947. A worthy companion to the six previous volumes used by over 100,000 shrewd radio servicemen. There is no

need to spend large sums for bulky, space-wasting manuals or to buy additional drawings every few weeks—get this low-priced new SUPREME PUBLICATIONS manual and you have service information on all popular 1947 sets. Covers 327 models, of 52 different manufacturers. Large size: 8½x11 in., 192 pages + index. Manual style binding. Price postpaid, **\$2.00** only .....

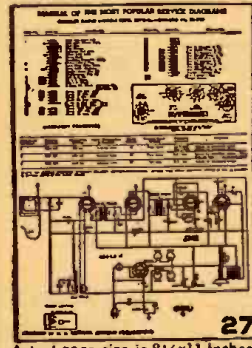

Actual page size is 8½x11 inches

### Most Popular Models Made by:

R. G. A., Zenith, Philco, Sears, Fada, Emerson, Belmont, Detrola Radio, Majestic, United Motors, G.E., Westinghouse, Arvin, Stewart-Warner, Admiral, Delco, Stromberg - Carlson, Western Auto, Wards, Spartan, Motorola, Gamble, Crosley, and many others.

### Guarantee

All manuals sold on 10-day trial basis. You must be entirely satisfied or your money will be refunded.

Supreme Publications (in business 14 years)

Speed up and simplify all radio set repairs with SUPREME PUBLICATIONS Manuals. Service radios faster, better, easier, save money and time, use these most-often-needed diagram manuals to get ahead, earn more per hour. At unbelievable low cost (only \$2 for most volumes) you are assured of having in your shop and on the job, needed diagrams and other essential repair data on 4 out of 5 sets you will ever service. Every popular radio of every make from old-timers to new 1947 sets, is included. Clearly printed circuits, parts lists, alignment data, and helpful service hints are the facts you need to improve your servicing ability. Save hours each day, every day, let these seven volumes furnish diagrams for 80% of all sets. See pictures of these attractive manuals above. Each volume has between 192 and 240 pages, large size 8½ x 11 inches. Manual style binding. Send coupon today. Complete satisfaction guaranteed.



Compiled by M. N. Beltman, radio engineer, teacher, author, and serviceman.

### Post-War Automatic Record Changers

Service expertly all new (1945-1947) record changers. Follow simplified factory instructions to make needed adjustments and repairs. Hundreds of photographs and exploded views; thousands of test hints; service instructions for all popular makes. Large size: 8½ x 11", 144 fact-filled pages. At your jobber or postpaid, only **\$1.50**

### Pre-War Record Players, Changers, & Recorders.

Just what you need to repair quickly thousands of pre-war automatic record changers, manual units, pick-ups, wireless oscillators, recorders, and combinations. Hundreds of mechanical and electrical diagrams. Instructions for adjustments and repairs. Most popular units of all makes. 128 large pages. 8½ x 11 inches. Price, only **\$1.50**

See Your Radio Jobber or Send Coupon →

# Supreme Publications

PUBLISHERS OF RADIO BOOKS, MANUALS, AND DIAGRAMS

9 South Kedzie Ave.

Chicago, 12, Illinois

### NO RISK TRIAL ORDER COUPON

SUPREME PUBLICATIONS, 9 S. Kedzie Ave., Chicago 12, ILL. Ship the following manuals: (Satisfaction guaranteed or money back)

- |   |                                     |  |
|---|-------------------------------------|--|
| <input type="checkbox"/> 1947               | } PRICED AT ONLY <b>\$2.00</b> EACH | <input type="checkbox"/> Post-War Record Changers...@ \$1.50         |
| <input type="checkbox"/> 1946               |                                     | <input type="checkbox"/> Pre-War Record Players...@ 1.50             |
| <input type="checkbox"/> 1942               |                                     |  |
| <input type="checkbox"/> 1941               |                                     | <input type="checkbox"/> I am enclosing \$.....send postpaid.        |
| <input type="checkbox"/> 1940               |                                     | <input type="checkbox"/> Send C.O.D. I am enclosing \$..... deposit. |
| <input type="checkbox"/> 1939               |                                     |  |
| <input type="checkbox"/> 1926-1938 @ \$2.50 |                                     |  |

Name: .....  
Address: .....

Minimum order \$3.00—All prices subject to change—25% deposit with COD orders



**GENERAL ELECTRIC  
150 WATT  
TRANSMITTER**  
Cost the Government \$1800.00  
Cost to you \$44.50!!!!

This is the famous transmitter used in U.S. Army bombers and ground stations, during the war. Its design and construction have been proved in service, under all kinds of

conditions, all over the world. The entire frequency range is covered by means of plug-in tuning units which are included. Each tuning unit has its own oscillator and power amplifier coils and condensers, and antenna tuning circuits—all designed to operate at top efficiency within its particular frequency range. Transmitter and accessories are finished in black crackle, and the milliammeter, voltmeter, and RF ammeter are mounted on the front panel. Here are the specifications: **FREQUENCY RANGE:** 200' to 500 KC and 1500 to 12,500 KC. (Will operate on 10 and 20 meter band with slight modification). **OSCILLATOR:** Self-excited, thermo compensated, and hand calibrated. **POWER AMPLIFIER:** Neutralized class "C" stage, using 211 tube, and equipped with antenna coupling circuit which matches practically any length antenna. **MODULATOR:** Class "B"—uses two 211 tubes. **POWER SUPPLY:** Supplied complete with dynamotor which furnishes 1000V at 850 MA. Complete instructions are furnished to operate set from 110V AC. **SIZE:** 21 1/2 x 23 x 9 1/2 inches. Total shipping weight 200 lbs., complete with all tubes, dynamotor power supply, five tuning units, antenna tuning unit and the essential plugs. These units have been removed from unused aircraft but are guaranteed to be in perfect condition.

**BENDIX SCR 522—Very High Frequency Voice Transmitter-Receiver—100 to 156 MC.** This job was good enough for the Joint Command to make it standard equipment in everything that flew, even though each set cost the Govt. \$2500.00. Crystal Controlled and Amplitude Modulated—**HIGH TRANSMITTER OUTPUT** and 3 Microvolt Receiver Sensitivity gave good communication up to 180 miles at high altitudes. Receiver has ten tubes and transmitter has seven tubes, including two 832's. Furnished complete with 17 tubes, remote control unit, 4 crystals, 24 volt dynamotor and the special wide band VHF antenna that was designed for this set. These sets have been removed from unused aircraft and are guaranteed to be in perfect condition. We include free parts and diagrams for the conversion to "continuously-variable frequency coverage" in the receiver. The cost of this unit is only \$37.95.

**BRAND NEW 12 VOLT DYNAMOTOR for SCR 522—\$12.00.** 24 volt dynamotor—\$6.00. Used SCR 522, less dynamotor, remote control unit and antenna—as is—\$19.95. Wide band VHF antennas—\$1.95.

**BRAND NEW BC 348 COMMUNICATIONS RECEIVER**

Featuring coverage from 200 to 500 Kc. and 1500 to 18,000 Kc on a direct reading dial with the finest vernier drive to be found on any radio at any price—high sensitivity with a high degree of stability—crystal filter—BFO with pitch control—standard 6 volt tubes. Contains a plate supply dynamotor in a compartment within the black crackle finished cabinet, the removal of the dynamotor leaves plenty of room for the installation of a 110V, 25 or 60 cycle power supply. These receivers, which make any civilian communications receiver priced under \$200.00 look cheap and shabby by comparison, are only \$69.95 brand new. Power supply kit for conversion to 110V 25 or 60 cycles, is only \$8.50 additional.

**SCR-274N COMMAND SET**

The greatest radio equipment value in history

A mountain of valuable equipment that includes 3 receivers that use plug-in coils, and consequently can be changed to any frequencies desired without conversion. Also included are two Tuning Control Boxes; 1 Antenna Coupling Box; four 28V. Dynamotors (easily converted to 110V. operation); two 40-Watt Transmitters including crystals, and Pre-amplifier and Modulator. 29 tubes supplied in all. Only a limited quantity available, so get your order in fast. Removed from unused aircraft and in guaranteed electrical condition. A super value at \$29.95, including crank type tuning knobs for receivers.

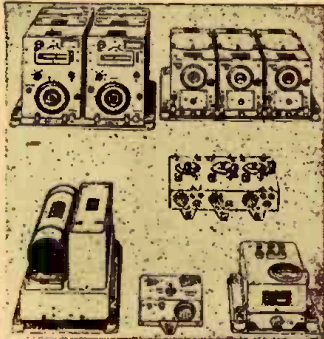

**1948 MODEL MUTUAL CONDUCTANCE TUBE TESTER . . . . . \$49.95**

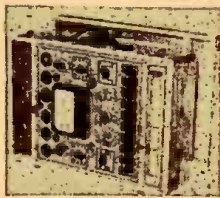

No possibility of good tubes reading "Bad" or bad tubes reading "Good" as on dynamic conductance testers or other ordinary emission testers. Attractive panel and a case equal to any on the market in appearance . . . Large 4 1/2" meter . . . Calibrated microhmho scale as well as a Bad-Good scale . . . Front panel fuse . . . Individual sockets for all tube base types—voltages from .75 volts to 117 volts and complete switching flexibility allow all present and future tubes to be tested regardless of location of elements on tube base . . . Indicates gas content and detects shorts or opens on each individual section of all local, octal and miniature tubes, including cold cathode, magic eye and voltage regulator tubes, as well as all ballast resistors. Name of the nationally known manufacturer withheld because of special price offer.  
Model "C"—Sloping front corner case . . . . . \$49.95  
Model "P"—Handsome hand-rubber portable case . . . . . \$54.95  
Built-in roll chart with either of above 5.00 extra.

**SUPER SPECIALS YOU CAN'T NEGLECT**

**GOVT. AUDIO AMPLIFIER** using 6V6's. 2 mike inputs and output at various impedance taps brought to jacks at rear panel. 9" high x 9" long x 6" deep. Shipping weight 18 lbs. 2 Tech manuals and tubes included—\$4.95.  
**Headphone Snoop—RS30** headphones in guaranteed perfect condition. Rubber earpieces included. \$5.99 per pair OR 3 PAIRS FOR \$1.00.  
**RT-1579** consists of a three stage (cascade 6S17s and 6F6 output stage) high gain, high fidelity amplifier with 60 cycle, 110V power supply on the same 13 1/2 x 1 1/2 chassis, which is protected by a substantial steel cover over tubes and parts. Made by Western Electric with typical quality component such as a hunky power transformer and oil condensers, this unit is obviously intended to give years of trouble-free service with no more need for repairs than a telephone. Disconnecting one wire each, from the special input and output filters, will result in as high a fidelity amplifier as can be obtained. Your cost with tubes, diagram and parts list included—\$14.95.  
We also offer the RT-1579 with a Raytheon Magnetic Voltage Regulator already installed beneath the cover. Imagine an amplifier complete with tubes, built to Western Electric quality standards, and immune to line voltage variations besides, making it perfectly suited for the most difficult industrial, circus, carnival, or commercial installations, offered for a total price of only \$19.95, our price for both units (With-out explicit instructions to the contrary, the RT-1579 will be shipped for \$14.95 without regulator on orders for both units that are received after the voltage regulator supply is exhausted.)

**IMMEDIATE DELIVERY ON THESE SUPER-SPECIALS IN TEST EQUIPMENT!**

**MODEL 431**  
AC-DC Volt-Ohm-Milliammeter  
Volts DC: 0-30/300/1500, at 2000 ohms-per volt  
Volts AC: 0-15/150, at 1000' ohms-per volt  
Milliamperes DC: 0-150  
Ohms: 3000/300,000  
Employs sensitive 425 microampers square meter, on aluminum panel. Two jacks are used for all ranges, by means of rotary selector switch. In handsome steel case, with snap-on carrying strap, complete with test leads. Shipping weight, 4 lbs.  
**YOUR COST, \$18.10**



**SIMPLEX VOLT-OHM-MILLIAMMETERS**

These two instruments are housed in bakelite cases, and employ 2-inch meters.

**MODEL 371**  
Volts DC: 0-3/15/30/300  
Milliamperes DC: 0-25  
Ohms: 0-10,000  
With self-contained battery.  
**YOUR COST, \$5.10**

**MODEL 312**  
Volts AC and DC: 0/25/50/125/250  
Milliamperes AC and DC: 0-50  
Ohms: 0-100,000  
Capacity Meter: -.05 to 15 Mfd.  
This instrument operates from any 110V outlet. Shipping weight, 2 lbs.  
**YOUR COST, \$8.60**

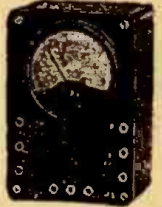

**MULTI-RANGE AC-DC VOLT-OHM-MILLIAMMETER WITH OUTPUT RANGES**

Volts DC: 0-5/10/50/100/500/2000, 1000 ohms-per-volt  
Volts AC: 0-12.5/25/125/250/1250  
Milliamperes DC: 0-1/10/100  
Milliamperes AC: 0-2.5/25/250  
Ohms: 0-1000/200,000/2,000,000  
Output: -5 to +65 Decibels  
Overall Accuracy: -1%

**5 1/2" INCH RECTANGULAR METER**  
with two-tone aluminum scale, set at a 45° angle for easiest reading. Special-treated aluminum panel, mounted on a wrinkle finish welded steel case, equipped with rubber feet and collapsible handle for portability. Complete with self-contained battery and test leads.  
Shipping weight, 8 lbs. **YOUR COST, \$25.20**

**FEATHERWEIGHT MINIATURE MODELS**

Just slightly larger than a pack of cigarettes, though they feature high accuracy, large, easily readable scales, and rotary-switch range selection. Average weight, only 12 oz.; shipping weight, 2 lbs.

**MODEL 450**  
Volts DC: 0-5/10/50/500/1000, at 1000 ohms-per-volt  
Milliamperes DC: 0-1  
Ohms: 5000/50,000/500,000  
**YOUR COST, \$10.60**

**MODEL 451**  
Volts DC: 0-10/50/100/500/1000  
Volts AC & Output: 0-10/50/100/500/1000  
Ohms: 0-500,000, 1000 ohms-per-volt on all ranges.  
Condenser is built-in for output ranges  
**YOUR COST, \$14.50**

**MODEL 452**  
Volts DC: 0-10/50/100/500/1000  
Ohms: 200/20,000/200,000/2,000,000, 10,000 Ohms-per-volt on all ranges  
Has sensitive 100 microampere meter  
**YOUR COST, \$14.50**

# RADIOMEN'S HEADQUARTERS WORLD WIDE MAIL ORDER SERVICE!!!

## BC-947A ONE KILOWATT HIGH FREQUENCY TRANSMITTER

This relay-controlled transmitter includes a 115V, 60 cycle power supply, protected by 8 magnetic circuit breakers, that alone is worth more than the price we are asking for the whole rig, even on today's surplus market. On the front panel are six 3 1/2" GE or Weston meters, including 250 MA, 50 MA, 1000 MA, 150V AC, and 1600V DC at 1000 ohms per volt for screens and plate. The rack-type 21"x15"x8 1/2" unit contains six amplifier and rectifier tubes aggregating over \$60.00 at WAA current wholesale prices. Western Electric's price to the government was \$1500.00. Shipping weight 500 lbs. Your cost, as is, only \$69.95.

## AT LAST YOU CAN AFFORD A LABORATORY STANDARD SIGNAL GENERATOR

The famous Measurements Corp. Model 78B, 5 Tube Laboratory Standard Signal Generator (currently selling new, FOB Boonton, N. J., for \$310.00 net), is available in perfect condition for 25 to 60 cycles, 115 V AC operation. Until now this is the sort of top-flight lab equipment that discriminating buyers have only vainly hoped would be released at a bargain price. Worth every cent the manufacturer asks, but available FOB Buffalo while our limited supply lasts for only \$79.95.



Model 78-B Standard Signal Generator. Two Frequency Bands between 15 and 250 mcperycles.

Such companies as Admiral Corp. and John Meek, Inc., have ordered from us and repeated many times on these 78 generators for use in their labs and production line testing.

"REMEMBER THAT A STANDARD IS ONLY AS RELIABLE AS ITS MAKER."

5" "SD" RADAR P.P.I. OSCILLOSCOPE, complete with 9 tubes. This unit contains magnetic deflection yokes and a Selsyn motor and has a self-contained power supply designed to run on the AC supply on LST or PT boats. The most satisfactory scope available for navigational radar or Panoramic television applications. Uses 807 tube in final-power stage that provides yoke deflecting current. Your cost \$39.95. "50" RADAR ECHO BOXES, THE PERFECT CALIBRATED CAVITY WAVEMETER—\$10.00.

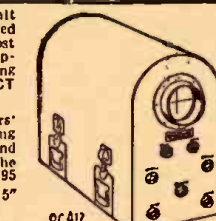

BC412

5 INCH RADAR OSCILLOSCOPE BC-412. Easily converted by a few hours' work to a first class lab scope or to an excellent home television receiver using the instructions in the August 1947 RADIO NEWS. Furnished with a brand new 5BP4 tube for the television application and a brand new 5BP1 for the scope application. Specify your choice. Your cost \$59.95.

LORAN INDICATOR OSCILLOSCOPE, complete with 28 tubes and a 5" cathode ray tube, government instruction manual included—\$39.95.

2 INCH OSCILLOSCOPE EQUIPPED WITH 2API TUBE \$9.95

5 INCH RECEIVER INDICATOR SCOPE. This unit, originally sold by Western Electric for \$2000.00 includes a 13 tube receiver with 7 IF stages; 2 tube multivibrator sweep generator; 2 tube sweep amplifier; video amplifier; pedestal impulse and sweep generator, and 115 volt, 60 cycle supply with 2 x 2 for high voltage. Supplied with at least 29 of the original 40 odd tubes, including a new separately crated scope tube. Makes a wonderful laboratory instrument and is better adapted for television than any other war surplus item. Your cost \$69.95

## GENERAL ELECTRIC RT-1248 15-TUBE TRANSMITTER-RECEIVER

TERRIFIC POWER—(20 watts) on any two instantly selected, easily pre-adjusted frequencies from 435 to 500 Mc. Transmitter uses 5 tubes including a Western Electric 316 A as final. Receiver uses 10 tubes including 855's, as first detector and oscillator, and 3-7HT's as IF's, with 4 slug-tuned 40 Mc. IF transformers, plus a 7HT, 7EZ's and 7FT's. In addition unit contains 3 relays designed to operate any sort of external equipment when actuated by a receiver from a similar set elsewhere. Originally designed for 12 volt operation, power supply is not included, as it is a cinch for any amateur to connect this unit for 110V AC, using any supply capable of 400V DC at 135 MA. The ideal unit for use in mobile or stationary service in the Citizen's Radio Telephone Band where no license is necessary. Instructions and diagrams supplied for running the RT-1248 transmitter on either code or voice, in AM or FM transmission or reception, for use as a mobile public address system, as on 80 to 110 Mc. FM broadcast receiver, as a Facsimile transmitter or receiver, as an amateur television transmitter or receiver, for remote control relay hookups, for Goligol, Miller counter applications. It sells for only \$29.95 or two for \$53.90. If desired for mobile use the dynamotor which will work on either 12 or 24V DC and supply all power for the set is only \$15.00 additional.

## ARMY BC-312 COMMUNICATIONS RECEIVER

This receiver covers the frequency range of 1.5 MC to 18 MC in six direct reading bands. The dial is driven with split gears to prevent backlash, has 4500 locking divisions per band with approximately 600 divisions on the 20 and 40 meter ham bands and 1000 divisions on 80 meters. Two stages of RF before the converter in this set give it a very high signal to noise ratio and maximum sensitivity. Outstanding features of this receiver are: BFO with pitch control send receive relay, jacks on the front panel for headphones and speaker output, and mike and key inputs. All tubes are standard 6 volt types. This receiver was designed to withstand rough usage in the field and for operation from vehicles while in motion, so it is ruggedly constructed and contains a dynamotor power supply—Your cost \$49.95. Conversion kit to 110 V AC is available for \$6.50

RT1463 7 tube amplifiers containing 3-7F7, 1-7Y4, 3-7N7, 4 potentiometers, numerous resistors, filter and bypass condensers, filter chokes, power and audio transformers, and six sensitive plate relays. A military development that provided amazing stepless control proportional to correction required, for alterations, rudder and elevator, in the original application. A control amplifier of the ordinary type would deflect the rudder by some arbitrary amount when the ship was blown off the course to port or starboard. The result would either be that the correction was insufficient and the plane continued off course, or the correction would be too great, starting a series of tacks that would greatly increase fuel consumption and elapsed time in reaching the objective. This phenomenal unit, with its 3 amplifiers and six 5000 ohm relays in bridge circuits, will accurately control any 3 operations, related or unrelated, in minutely adjustable uniquely quantitative variations in either forward or reverse directions. 9"x7"x8" black crackle aluminum case. Brand new in original carton \$12.95, or used \$9.95.

## PE-109 32-Volt DIRECT CURRENT POWER PLANT

This power plant consists of a gasoline engine that is direct coupled to a 2000 watt 32 volt DC generator. This unit is ideal for use in locations that are not serviced by commercial power or to run many of the surplus items that require 24-32V DC for operation. The price of this power plant is only \$59.95. We can also supply a converter that will supply 110v AC from the above unit or from any 20-32V DC source for \$29.95.

SCR-284 TRANSMITTER-RECEIVER—This medium power transmitter and the accompanying 7 tube very sensitive receiver are naturals for 80 or 40 meter operation (phone or CW), on either fixed stations or mobile applications. These units are brand new and come complete with 17 tubes, key, microphone, 200 KC calibrating crystal and instructions and diagrams for use with up to 100 watts input to the final stage on 40 or 80 meters for either phone or CW, using vehicle or 110 Volt power supply. Your cost \$39.95

SCR-610 or BC-659 TEN METER TRANSMITTER-RECEIVER. Voice only FM, 27 to 38.9 MC, crystal controlled, 2 watts output, 6, 12, or 24 volt DC input. The ideal battery powered portable \$49.95

## SERVICEMEN

Check This Column for Lowest Prices on Quality Parts

TUBES: all types in stock, 60% off on all tubes if ordered in lots of 10 or more.

RESISTOR KITS—100 assorted 2 watt resistors—only \$1.95. TRANSFORMERS—All types in stock. AUTO TRANSFORMERS: Step up 110v to 220v, or step down 220v to 110v—\$1.95. FIL. TRANS.: 6.3v, 20 Amps.—\$1.98; Universal Output Trans. 8 Watt—89c; 18 Watt—\$1.29; 30 Watt—\$1.69. AUDIO TRANSFORMERS: S. Plate to S. Grid, 3:1—79c; S. Plate to P.P. Grids—79c; Heavy Duty Class AB or B, P.P. Inputs—\$1.49; Midget Output for AC-DC sets—69c; MIKE TRANSFORMER for T-17 Shure microphone, similar to UTC ouncer type—\$2.00. Stancor SB or DB mike to line or grid—\$1.95.

POWER TRANSFORMERS—Half-shell type, 110V, 60 cy. Center-tapped HV winding. Specify either 2.5 or 6.8V filament when ordering. For 4-5 tube sets—450MA, 40MA, 5V & 2.5 or 6.3V.....\$1.49 For 5-6 tube sets—650V, 45MA, 5V & 2.5 or 6.3V..... 1.75 For 6-7 tube sets—675V, 50MA, 5V & 2.5 or 6.3V..... 1.90 For 7-8 tube sets—700V, 70MA, 5V & 6.3 or two 2.5V.... 2.35 For 7-8 tube sets—700V, 70MA, 5V & 6.3 (25 cycle).... 3.60 For 8-9 tube sets—700V-90MA, 5V-8A, 2.5V-3.5A, 2.5-10.5A..... 2.65 For 9-11 tube sets—700V, 100MA, 5V & 6.3V-4A..... 2.85 For 9-15 tube sets—800V, 150MA, 5V & 0.3V..... 2.95

CONDENSERS—PAPER TUBULAR 600 WVV—001, 002, 005—.8c; .ul. .05—.9c; 1—.10c; .25—.23c; .6—.9c; ELECTROLYTIC: 8mfd 200v—20c; 10mfd 35v—20c; 20mfd 150v—23c; 20/30v—15c; 50/20v—35c; 50mfd 150v—43c; 8mfd 475v—34c; 16mfd 350v—65c; OX. CONDENSERS: 4mfd 600v—49c; 2mfd 600v—29c; 3X LMFD 600v—29c.

FILTER CHOKES: 200, 300, 400, 500 ohm light duty—59c; 200 or 300 ohm heavy duty—99c; 250 ma 35 ohm, made for U.S. Navy, fully shielded—\$1.95; 75 ohm 125 ma—25c or 25 for \$4.25; "Meissner type" tapped filter chokes—25c; 8 amp. iron core A filter—25c; Choke-condenser combination, ideal to replace any size speaker field when installing PM speakers—79c.

110 V. CIRCUIT BREAKERS of Magnetic type: Following Current Ratings in Stock; 1.25, 3, 4, 8 Amps. Please specify. \$1.95 each. Seven Assorted I.F. Transformers—\$1.98; Five Assd. Oscillator Coils—69c.

SPEAKERS—PM dynamic type—4"—\$1.55; 5" \$1.55; 6"—\$1.95; 8"—\$2.95; 10"—\$5.95; 12"—\$9.95.

SELENIUM RECTIFIERS—Dry disc type 1 1/2" by 1", 1.2 Amp. maximum, suitable for converting DC relays to AC, for supplying filament source in portable radios, converting DC meters to AC applications, and also may be used in low current heaters—90c.

METER RECTIFIERS—Full wave, may be used for replacement, or in construction of all types of test equipment—\$1.25 Half Wave—80c.

MICROPHONES—All nationally known brands. Bullet crystal—65.45; Bullet Dynamic—\$7.45; Mike Jr.—60c; Handy Mike—90c; Lapel Mike—83c; SHURE T-17 MIKES, with push to talk switch—95c.

ASSTD COIL FORMS, including 11 ceramic, 3 polystyrene, and 6 fiber, all useful sizes—50c.

VARIABLE CONDENSERS: 350 MMF, 6 gang—\$1.95; 4 gang—\$1.49; 3 gang—83c; 2 gang—79c; 7.5 to 20 MMF, 1750v spacing, extra long shaft, Hammarlund—69c; miniature variable, 25 MMFD—59c; 50 MMFD—49c; 75 MMFD—59c; 100 MMFD—69c; 140 MMFD—79c.

TRANSMITTING RF CHOKES, 4 PIE, 350 Ma.—25c or 5 for \$1.00. INTERRUPTION FREQUENCY COILS for super-regenerative receivers or the tremendously popular FM adapters for standard broadcast sets. Iron core with a resonant frequency of 50 KC—39c; Air Core, 100 KC—29c.

30 MC IF TRANSFORMERS, double slug tuned—25c VIDEO AMPLIFIER PLATE COILS—Slug tuned—25c. REMOTE CONTROL UNIT: Aluminum case 4.3x2" containing 2 potentiometers, triple pole switch, 4 knobs, gear mechanism, counter and phone jacks—59c.

MODULATION TRANSFORMERS—10 watt, metal case, 99c; 30 watt, open type, \$1.95; 40 watt, cast aluminum case, \$2.95; Class "B" input transformers, cast aluminum case, \$1.85; Transceiver audio transformer, 65c; Transceiver modulation transformers, 65c.

PUBLIC ADDRESS AMPLIFIERS—25 watts peak output. This unit has separate input circuits for microphone and phone. The gain of the microphone circuit is 122db. The phone circuit has gain 82db. The frequency response is flat from 50 to 12,000 cycles. A \$65 value for only \$32. Miniature Plier set contains one of each of the following: Needle nose, flat nose, parrot nose, standard nose. All contained in a leatherette case. Your cost—\$1.98.

ATR battery eliminator—Handy for service car radios or any other purpose requiring 6 or 12v at 14 amps. Net price—\$38. SOCKET WRENCH SET consisting of 5 sockets ranging in size from 5/16 to 3/4" and a handle—79c.

AUTOMATIC WIRE STRIPPERS will strip up to 1000 wires per hour, a handy tool for any service job—\$3.52. Six Foot Asbestos Insulated Flat Iron Cord, one end has a male plug, the other end has a standard flat iron socket. Your price—70c each or 10 for \$5.

LINE FILTERS—110V—each unit contains two 2 mfd. oil filled condensers and a 15 amp. iron core choke. This filter has innumerable uses such as oil burner line filter, etc. A ten dollar value for 98c.

Crystal pick-up phono motor and turntable—\$5.25. FLUORESCENT LIGHT BALLASTS, Single 30 or 40 watt, \$1.89; Dual 40 watt, High Power Fa-10—\$3.75. HEADPHONES—Highest quality Signal Corps headsets with 12" cord and plug \$1.25. 6" rubber covered tele-cords with phone plug and socket—45c.

BC-221 FREQUENCY METERS with calibrating Crystal and calibration charts. A precision frequency standard that is useful for innumerable applications for laboratory technician, service man, amateur, and experimenter at the give away price of only \$39.95.

BUFFALO RADIO SUPPLY, 219-221 Genesee St., Dept. 12C, BUFFALO 3, N. Y.

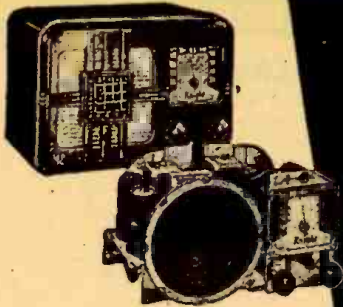

## RADIO BUILDERS and EXPERIMENTERS!

# ALLIED is Your Headquarters for Radio Kits!

### Low-Cost Knight "Ranger" 5-Tube Kit Complete with Cab- inet, Loop Antenna and Tubes

It's here! The first ultra-modern 5-Tube AC-DC Superhet kit at so low a price! Here's what you get—full broadcast band coverage (550-1600 Kc.); built-in loop antenna; latest 5" PM dynamic speaker; handsome walnut plastic cabinet. Unbelievably easy to build; no special tools required. Sockets are riveted in place on chassis base; just assemble, wire and slip into cabinet. Outstanding for power and tone quality. Highest grade components only. Complete with all parts, tubes and full instructions. Nothing like it at the price! Shpg. wt. 10 lbs. **\$14.95**  
No. 83-275. Complete, only.....

### ALLIED and the Radio Builder

The typical ALLIED-Knight Kits presented here are the result of over 20 years of experience in engineering efficient, easily-assembled kits. Every kit is proved for circuit design, good mechanical layout, and high quality components. **KNIGHT** Kits are easiest to assemble: complete instructions include both pictorial and schematic diagrams; panels are drilled, screenprinted and calibrated; chassis is formed and all holes are punched for you—no holes to drill; every last part required is included. When you buy a **KNIGHT** Kit, you get top design, top quality and top value.

### High-Fidelity Kits for Radio Reception or Record Playing

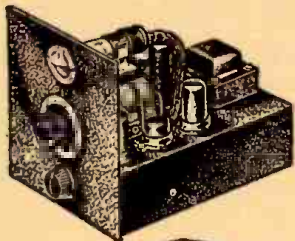

**TRF BROADCAST TUNER.** An easy-to-build high-fidelity TRF Tuner Kit. Features broad band reception for higher fidelity than obtainable in standard superhet circuits. Linear diode detection for quality demodulation; separate diode AVC for constant signal. Cathode follower output circuit. "Magic Eye" tuning. Vernier dial, 0-100, 5-1 ratio. Built-in power supply. Complete with all quality parts, including 5 tubes plus rectifier, punched chassis (10 x 6½ x 3") and panel, matched coils and detailed 4-page instruction booklet. For 110-125 volt, 60 cycles AC. **\$24.25**  
83-221. NET, only.....

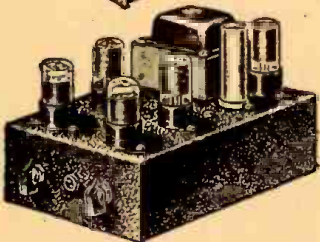

**10-WATT HI-FI AMPLIFIER.** One of the finest high-fidelity audio amplifiers ever designed for home construction—a perfect companion for tuner above, or for use with crystal phono pickup. Inverse feedback for wide response ± 1.5 db from 20 to 10,000 cps. Minimum distortion. High impedance input; volume and tone controls; large output transformer matches any 6-8 ohm PM speaker. Complete with all quality parts, including 4 tubes plus rectifier, punched chassis (10 x 6½ x 3"), and detailed 4-page instruction booklet with large, clear schematic and pictorial diagrams. **\$21.75**  
83-222. NET, only.....

**POPULAR 2-METER TRANSCEIVER.** It's easy to build this powerful, compact 2-meter transceiver. Fine engineering brings unusually high output efficiency. Supplies current for single button carbon mike. Output transformer for any PM speaker or headphones. Requires 250 v. at 75 ma., and 6.3 v. at .65 amp. for power. Kit complete with all parts: punched and formed cadmium plated chassis, 5 x 9 x 2", clearly marked 6 x 9" steel front panel with black crackle finish, tubes, wire, solder, etc. Includes easy-to-follow instructions. Requires Amateur license to transmit. Kit complete, less mike, speaker and power supply. **\$18.25**  
83-220. NET, only.....

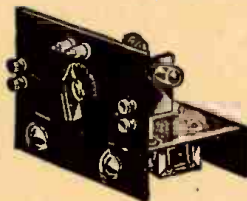

For Additional **KNIGHT** Kits, see **ALLIED'S 164 Page FREE Catalog!**

# ALLIED RADIO

Everything in Radio  
and Electronics

ALLIED RADIO CORP., Dept 2-M-7  
833 W. Jackson Blvd., Chicago 7, Ill.

- Send Kit No. 83-275  
 Send Kit No. 83-221  
 Send Kit No. 83-222 } Enclosed  
 Send Kit No. 83-220  
 Send FREE 164-Page ALLIED Catalog.

Name.....

Address.....

City.....Zone.....State.....

## TECHNOTES

### ... 25D8 SUBSTITUTION

When 25D8's are not available, make an adapter for mounting a 12BA6 and a 12AT6 in the base of the 28D8. Connect the filaments in series and wire the other terminals to the pins of the old tube. Shield the external grid lead to prevent oscillations.

A. W. POWELL,  
Rolfe, Iowa

### ... MOTOROLA 55X11 AND 55X11A

Intermittent reception in these models sometimes can be traced to a rivet on the speaker frame. This rivet is insulated and used as a terminal for one of the voice coil leads—the other is intentionally grounded to the frame. When the insulated rivet develops a short to the frame, it short-circuits the voice coil. A simple remedy is to remove the voice coil lead from the rivet and connect it to an insulated mounting lug that has been soldered to the defective rivet.

C. T. MARTOWICZ,  
New York, N. Y.

## Now... THE KEY to SUCCESSFUL TELEVISION SERVICING!

Compilation of confidential Television Notes and Information, the product of experience with 10,000 television receivers, available now for the first time!

TRANSVISION'S "SERVICE NOTES" is the most valuable compilation of instructions and data on Magnetic and Electrostatic Television Receivers. Though compiled in course of servicing Transvision kits, the information is applicable to any type of television receiver.

"SERVICE NOTES" is complete with photographs and diagrams. The information is worth a small fortune. The cost is low... only \$2.95.

See your local distributor, or write to

# TRANSVISION

385 North Ave. New Rochelle, N. Y.

### FREE 8-PAGE FOLDER... Get this "SOLDERING (easy as A-B-C)"

FOR EVERY HOBBYIST, CRAFTSMAN, AND HANDY MAN AROUND THE HOME. Simple step-by-step illustrations explain how to tin soldering irons, bind and solder wire splices, unite metals, etc. No obligation, just send us your name and address today. We'll mail your soldering folder without charge.

UNGAR Electric Tools, Inc.  
P. O. BOX, 2285-Q, TERMINAL ANNEX  
LOS ANGELES 54, CALIF.





**Brand New Automatic Direction Finder  
RADIO COMPASS**

SCR-269F Complete with Component Parts Less Power Supply **\$75.00**

This equipment comes complete with 17 - tube superheterodyne receiver which is tunable from 200-1750 KC in three bands. A complete instruction book for operation and maintenance accompanies this equipment.

**BC 433G RECEIVER**

Complete with tubes, used in good condition. **\$29.50**

**Azimuth Control**

**49¢**

Dial calibrated, 360 face, ideal for antenna rationalizing indicator.

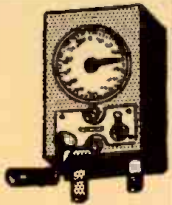

**T-17 CARBON MICROPHONE 89¢**  
Like new.

**BC-654**

**Transmitter & Receiver**

With tubes and xtals, used, in good condition. The frequency range of both transmitter and receiver is continuous from 3700 to 5800 KC; all stages gang tuned by anti-backlash worm gear dial mechanisms. ....\$12.50

**TRANSMITTER TUNING UNIT BC-375**

Approximately 65 MMFD cond., coils RF chokes, dials, assorted mica condensers, 2500 WVDC. Over \$50.00 parts! **\$1.95**

**DYNAMOTOR UNIT PE-101-C**

Duo output Dynamotor, input voltage 12 to 24V., output voltage 400V. at 135 ma, 800V at 20 ma, and 9 V. at 1.1 amp. **\$2.95**

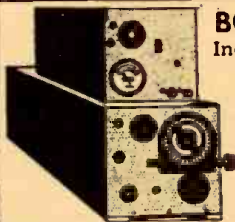

**BC-AR230 Transmitter**  
Including 4 tubes and Rf Amps. meter.

**BC-AL229 Receiver**  
Including 6 tubes. Used in aircraft.

**BOTH UNITS ONLY \$9.95**

**Overload Relay**

**\$1.95**



Patterson and Brumfield. Relay 1, 5,000 ohms, coil current 10 MA., Relay No. 2, 110V, 60 Cy, AC coil. S.P.D.T.

**POWER TRANS.**

**\$1.95** 110V, 60 cy. Sec. 1.4V at 16 Amps, Sec. 2: 2 1/2 V at 1.75 Amps. Ideal for 2x2 and 826 tubes. Hermetically sealed. size 6" x 3 1/2" x 4 1/4".

**IF TRANS.**

**95¢**



Mounted in aluminum shield can 1500 KC. with air trimmer. impedance coupled type.

**Variable Resistor**

2500 ohm. **49¢**  
100 W.



**FILAMENT TRANS FORMERS**

**Toggle Switch**

**39¢**



D.P.D.T. 30 Amps. in black Bakelite case.

**FM Radio and Transmitter BC-620-A, 20 MC - 27.9 MC \$9.95**

This Xtal controlled FM set has 13 tubes and has dual Xtal controlled channels. It also contains built-in Fil. and Plate Meter. Tubes used: (4) 1LN5, (1) 1LC6, (1) 1LH4, (2) 1291, (4) 1299, (1) 1294. Ideal for communication between Trucks, Boats, etc. Used, in good condition. Less power supply. Wt. 38 lbs. Complete with carrying case and diagrams.

**30MC IF TRANSFORMER 29¢**

Slugged Tune.

**Condensers**

Cap. MFD	Working Volt	Your Cost
1	1000 oil	44¢
8	600 oil	95¢
2	600 oil	49¢

**Squirrel Cage Blower \$7.50**

2" outlet, 110 AC, 60cy Silent Ball Bearing Motor, with mounting bracket.



Sockets for acorn tubes.....	\$ .19
Powdered iron 3/8 slug.....	.10
Jacks, PL55, PL68.....	.15
Asst. mica condensers.....	1.95
3 lbs. asst. hardware.....	1.00
Pin straightener for min. tubes.....	.49
Ear phones, 2000 ohms, used.....	.95
Johnson sockets, No. 210, 25W.....	.39

**CORONA BALLS \$1.00 Dozen 10¢ Each**

**High-Speed Photo Flash Tube 10,000 Flashes**

12,000,000 lumens light output. Stops all action. Ignition coil included on back of bulb. 10,000 flashes. Diagrams furnished. **\$8.95**



**TUBES**

813	5.95	872A	1.95
VR150	.69	9004	.49
955	.65	9006	.59
9002	.89	5085	.89
RK60	.95	VT127A	
9001	.89		2.95
6J4	1.50	35W4	.69
5 FP7	1.95	3AP1	1.95
7BP7	2.95	3BP1	1.95
9LP7	3.95	6J5	.49
6N7	.89	58P1	3.95
		6H6	.59
IT4, 3Q5, 6SN7	.59		
35A, 5W4,			
6SA7, 1G5,	<b>44¢</b>		
12H6,			
6SH7			

General Electric 25 MFD Photoflash pyramol capacitor, 2000 VDC-INT	\$14.95
SPST relay 24V, 528 ohm. coil contact rating 5 amp. Packed 2 to a carton.	2 for .49
Coaxial solid copper tubing, 30 foot.	2.95
30-20 MFD Solar condenser. 150 V. tubular.	.49
Assorted tubular oil-filled condensers, up to 5 MFD, 15 for.	1.00
3 lbs. assorted hardware.	1.00
Westinghouse oil 1MFD 6000V, WVDC.	7.95
144 MC radar osc., uses 15E with variable coupling. complete less tubes	3.95
Assorted high frequency chokes, 25 for.	1.00
Thordansen 300 MA power transformer, 110 or 220V, 60 cy. input, secondary 500/ct/100 tapped at 400/400 extra bias winding 200/ct/100 at 50 MA, 18 lbs.	4.95
Assorted resistors 1/2 watt fully insulated in popular ohmage, 100 for	1.49
Thordorsen T48003, 2H-7H 550 MA swing choke, size 4 1/2 x 5 1/2 x 5 1/2 square black crackle case. 15 lbs.	5.95
Assorted mica condensers, per 100.	1.95
Wafer sockets, 4, 5, 6, 7 and 8 prong, per 100.	2.95
12" Utah PM speaker Alinco No. 5 with 6F6 output transformer.	6.95
Assorted knobs, push on wood and plastic.	1.95



**89¢**

±1% 1 MEG.

**WRITE FOR FREE BULLETIN!**

**Hershel Radio Co.**

5249 GRAND RIVER • DETROIT 8, MICH.

20% DEPOSIT REQUIRED ON ALL ORDERS

All Orders F.O.B. Detroit **Minimum Order \$2.00** Michigan Customers Add 3% Sales Tax



**IFF TRANSMITTER AND RECEIVER \$9.95**

Successfully used as a television receiver. 30 MC I.F. channel and video amplifier; original diagram furnished. Less tubes and power transformer.

**BC223AX TRANSMITTER**

Complete with tubes and tuning unit covering 80 meter Ham band, including frequencies charts. less xtals. **\$12.50**

**GEN. ELECTRIC METER**

**\$3.95**



Type DO41, 3" 0-1 MA, meter scale graduation 0-5 D.C. Kilo V and 0 10 MA D.C.

**BK22K RELAY**



**\$2.95** Used in conjunction with SCR269F. changeover contains 29V, step relay, 5 deck, 6 position switch. 12V D.P.S.

**5 GANG VARIABLE CONDENSER**



**\$1.95**

5 gang, approx. 50 M.M.F.D. per section with individual air-tuned padders. 18 to 1 vernier drive.

**POWER TRANSFORMER**

**\$1.95** 110V, 60 cy Sec. 300V ea side of center of 125MA, 6.3V at 2.1 Amps, 5V at 3 Amps. Hermetically sealed. size 6" x 3 1/2" x 4 1/4".

**POWER TRANS.**

Primary 110V, 60 cy., Sec. 700V each side of center at 80MA, 6.3V at 1.2 Amps, 5V at 3 Amps. Hermetically sealed size 6" x 3 1/2" x 3".

In New Jersey...

...it's **VARIETY**...

Sensationally New

**TRANSVISION**

**12" TELEVISION KIT**

**STANDARD MODEL**  
—Picture size 7 1/2 square inches, 22 tubes and 12 inch picture tube. High fidelity FM sound reproduction. Advanced television circuit provides exceptionally clear pictures.



**DELUXE MODEL**—with Superb Built-in FM Radio.

12" Standard Television Kit.....\$289.50\*  
12" Deluxe Television—FM Radio Kit..... 359.50\*  
7" Television Kit..... 159.50\*

(\*Complete with tubes, less cabinet)  
Cabinet for 12" Television Receiver..... 44.95  
**REPUBLIC 7" TELEVISION KIT**

LESS CABINET \$165.00

Complete Line of Television Components  
DEALERS' PRICES ON REQUEST

**NEW!**

**PREMIER**

Model 570

**MICROMASTER**  
Band Spread Dial  
**SIGNAL**  
**GENERATOR**



For testing and aligning BROADCAST SHORT WAVE FM and TELEVISION RECEIVERS. Exclusive Band Spread Dial geared to the tuning condenser and main dial, giving a total scale length of approximately 60 inches. Three-color dial directly calibrated in Kilocycles and Megacycles. Range: 75 KC—150MC. Size: 12 1/4" x 12 1/4" x 5 1/4".

COMPLETE WITH TUBES AND CO-AXIAL CABLE.

**\$5475**  
NET

**ELECTRIC MOTOR KIT and BOOK**

Complete, everything provided, including two batteries, quality construction, precision parts, attractively packaged  
**\$3.99 ea.**  
Quantity Prices on Request

TAPPED OSCILLATOR COILS for 12SA7- 99  
6SA7..... 15c each, 10 for

DUAL 30 mmf. AIR TRIMMERS..... } 10 for 69c  
50 mmf. AIR TRIMMERS..... }

Bargain! Guaranteed!

100 Assorted Bypass Condensers 600V  
Value \$11.00.  
SPECIAL..... **\$6.95**

**SUPERIOR Model 670**

Super-Meter



A Combination Volt - Ohm Milliammeter plus Capacity Reactance Inductance and Decibel Measurements.

Complete with test leads and instructions..... **\$28.40**

Full line of Weston-R.C.P. Supreme Superior-R.M.S. Test Equipment

Write Dept. RC-12. 20% Deposit with order required. Please add sufficient postage. Excess will be required.

**Variety ELECTRIC CO., Inc.**  
601 Broad St., Newark 2, N. J.

**MAKING MAGNETIC PICKUPS**

By **EDWIN COOPER**

MY experiments with magnetic pickups for steel-stringed musical instruments have led to development of 3 models that work well. All models can be constructed cheaply and simply. Each uses Alnico magnets that may be obtained from discarded PM speakers, a coil of fine wire, and some scrap metal. Aluminum or brass will do.

The first model, shown in the photograph, consists of a magnet about 5/8 inch square and 1 1/4 inch long, a non-magnetic metal bracket, a 2 1/2 x 3-inch sheet of 1/4-inch plastic, a 2-inch piece of 1/4-inch steel rod, and a field coil from a small speaker. The coil used in this model is 3/4 inch thick, 1 1/4 inch outside, 3/4 inch inside diameter, 2,600 ohms, d.c. resistance. (Fig. 1).

Cut a hole in the center of the plastic plate so that it will make a snug fit around one end of the magnet. Insert the magnet in the hole so it projects about 1/16 inch through the plate. Place the field coil over the magnet and bend a U-shaped bracket from brass or aluminum so the magnet and coil can be fastened firmly to the plastic plate. Lay the steel rod across the top of the magnet and drill a small hole through each end. Tap the holes, drill corresponding holes in the plastic and bracket, and assemble the unit with brass screws. Connect the leads from the coil to the input jack of the amplifier.

For the second model (Fig. 2), 2 identical magnets from small speakers are used. The end plates are cut from

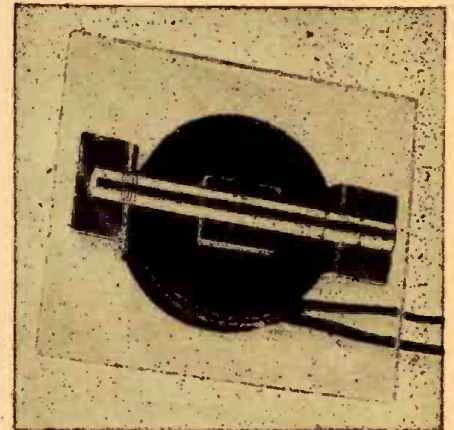

Fig. 1—A very simple and easily-made pickup.

very fine enamel-covered wire on the form made by the magnets and end plates. The coil should have a resistance of 2,000 ohms or more.

The third model (Fig. 3), works well but is slightly larger than the others. In this model, magnetic metal plates are used. Two magnets are mounted on the same end of the plates with like poles against the same plate.

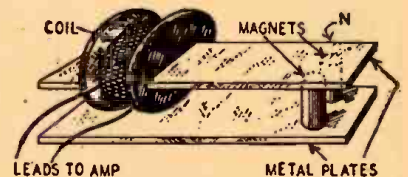

Fig. 3—Plates can be shorter when required.

A coil of many turns of fine wire is wound on the opposite end of one of the plates, as shown.

The pickups are mounted on the instrument just in front of the bridge. The first model has the rod at right angles to the strings, and the others have the planes of the coils at right angles to the strings.

(The impedance of the pickup coils depends on a number of variables. If the unit does not work well in the high-impedance input circuit of an amplifier, try using a multimatch input transformer and adjust for best performance.—Editor)

**SPEAKER SHIMS**

Good speaker shims, particularly for small speakers, can be made from rejected negatives from roll film. The material is 0.005 inch thick and of uniform stiffness. Negatives can be cut to fit exactly around the pole piece. Be careful not to get any service solvent on the shims.

THOMAS E. RUMNEY,  
Toronto, Canada

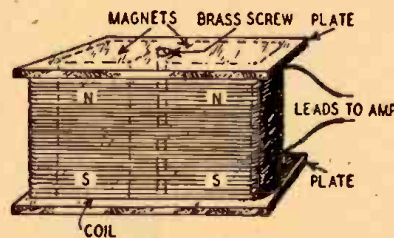

Fig. 2—Two magnets are used in this device.

nonmagnetic metal. These are long enough to extend about 1/8 inch on each side of the instrument strings and wide enough to form sides for the coil that is to be wound around the magnets—1/2 inch wider than the cross section of the magnets should be about right. Drill a hole in the center of each plate and tap one for a small screw. Locate the magnets as shown with like poles against the same plate. Hold the magnets in position with a brass screw through the holes in the plates.

To check the polarity of the magnets, place them end-to-end so that they do not attract and mark these ends. Place them against the same plate.

Wrap each magnet with 3 or 4 layers of Scotch tape. Wind a single coil of



*The New Model 257*

# ELECTRONIC ANALYZER

**THE MOST COMPLETE MULTI-RANGE,  
MULTI-SERVICE UNIT EVER DESIGNED!!**

**IT'S A HIGH FREQUENCY A. C.  
VACUUM TUBE VOLTMETER**

(A true A.C.-V.T.V.M. employing a 1-A3 Diode which together with a resistance-capacity network is built into a specially designed Polystyrene High Frequency Probe).

**IT'S A D.C. VACUUM TUBE VOLTMETER**

(At 11 megohms input resistance).

**IT'S A CAPACITY METER**

**IT'S A REACTANCE METER**

**IT'S AN INDUCTANCE METER**

**IT'S A DECIBEL METER**

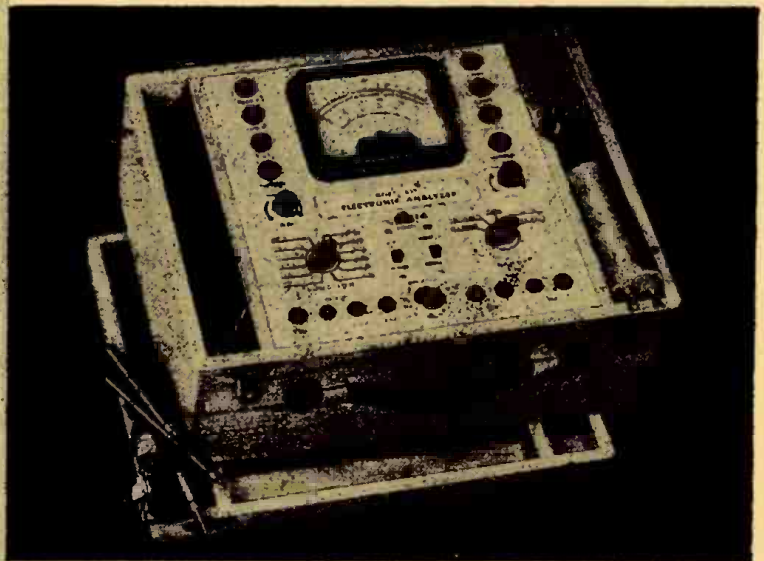

**IT'S A 1000 OHMS PER VOLT V. O. M.**

Measures D.C. Voltages (at 1,000 ohms per volt) up to 3,000 volts, A.C. Voltages (at 1000 ohms per volt) up to 3000 Volts, D.C. current up to .15 amperes, Resistance up to 1000 megohms.

**Sixty, yes Sixty separate ranges are provided by this most versatile unit ever designed.**

### Specifications

**A.C. V.T.V.M. VOLTS:** (Input resistance—10 megohms shunted by 8 micromicrofarads. Freq. Range—50 cycles to 500 Megacycles.)  
0 to 3/15/30/75/150/300 Volts.

**D.C. V.T.V.M. VOLTS:** (At 11 Megohms Input Resistance)  
0 to 3/15/30/75/150/300/750/1500/3000 Volts.

**D.C. VOLTS:** (At 1,000 Ohms Per Volt)  
0 to 3/15/30/75/150/300/750/1500/3000 Volts.

**A.C. VOLTS:** (At 1,000 Ohms Per Volt)  
0 to 3/15/30/75/150/300/750/1500/3000 Volts.

**D.C. CURRENT:**  
0 to 3/15/30/75/150/300/750 Ma.  
0 to 3/15 Amperes.

**RESISTANCE:**  
0 to 1,000/10,000/100,000 Ohms  
0 to 1/10/1,000 Megohms.

**CAPACITY:** (In MFD)  
.0005—2 .05—20 .5—200.

**REACTANCE:**  
10 to 5M (Ohms) 100—50M (Ohms).  
.01—5 (Megohms).

**INDUCTANCE:** (In Henries)  
.035—14 .35—140 35—14,000.

**DECIBELS:**  
—10 to +18 +10 to +38 +30 to +58.

*The Model 257 comes housed in a beautiful hand-rubbed oak cabinet complete with test leads, V.T.V.M. probes and instructions. Size: 6½" x 10¾" x 14".*

**\$64<sup>50</sup>**  
**Net**

**AVAILABLE FOR IMMEDIATE SHIPMENT FROM STOCK — 20% DEPOSIT REQUIRED ON ALL C. O. D. ORDERS**

**MOSS ELECTRONIC DISTRIBUTING CO.**

DEPT. RC 12, 229 FULTON ST.,  
NEW YORK 7, N. Y.

# SENSATIONAL SURPLUS SALE

**NAVY COMPARTMENT SPEAKER AMPLIFIER UNIT.**  
With Heavy Duty Speaker (32 oz.). Speaker alone worth \$25.00.

Works from 110 V. AC DC used, but in operating condition. Uses 35-Z5 rectifier and 2 35L6's in P.P. audio input 006 watts, 600 ohm imp. 5 channels selection input. Volume control with tubes in grey case 14x14x7/2. **\$9.95**



## FREQUENCY METER

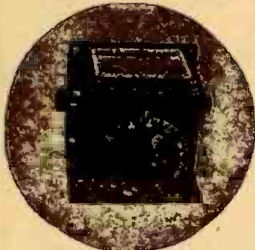

**\$3.49**

Value \$25.00

Directly calibrated on large vernier dial from 80 to 300 meg. Also includes Automatic switching arrangement. Beautiful black metal case. Instructions included.

## MALLORY LINE NOISE FILTER

**\$2.95**

Value \$10.00



Rating 110-220 V. (AC-DC). \$10.00 Value.

**A WIRE BUY** 1000 ft. \$3.50  
5000 ft. \$14.50  
No. 18-7. Strand Black Plastic 1/2" O.D.  
Indoor or Outdoor Wiring, 15,000 ft. (\$270 value) for \$33.00.



## CABINETS

CLOSE-OUT  
**\$1.43**  
each

12 or more \$1.25 each  
Radio or amplifier cabinets never again offered at these prices. All sturdily constructed. Stock up Now.

SEND POST CARD FOR LATEST BULLETIN

**MANUEL KLEIN**

74 CORTLANDT ST.  
NEW YORK 6, N. Y.

## WORLD WIDE STATION LIST

(Continued from page 88)

9.570	KWIX	SAN FRANCISCO, CALIF.: Alaskan beam, 0115 to 0345
9.580	GSC	LONDON, ENGLAND: 1100 to 1315; 1330 to 1415; 1430 to 1530; 1615 to 2300; 2345 to 0030
9.580	VLG	MELBOURNE, AUSTRALIA; 1100 to 1200
9.590	VQD5	DELHI, INDIA; 0900 to 1230
9.590	PCJ	HUIZEN, NETHERLANDS; 1400 to 1500; 1745 to 1815; 2000 to 2200
9.600	XEYU	MEXICO CITY, MEXICO
9.600	GRY	LONDON, ENGLAND: 1800 to 2230; 2300 to 0030; 1230 to 1600
9.910	ZRL	CAPTOWN, SOUTH AFRICA; 0300 to 0700; 0900 to 1030
9.910	ZYC8	RIO DE JANEIRO, BRAZIL; 1500 to 2200
9.910	VLC8	SHEPPARTON, AUSTRALIA; 0830 to 1200
9.910	TIP8	SAN JOSE, COSTA RICA; 0700 to 2330
9.920	XGNC	KALGAN, CHINA; 0400 to 0815
9.920	CXA8	MONTEVIDEO, URUGUAY; 1530 to 2100
9.920	GW0	LONDON, ENGLAND: 0045 to 0130; 0200 to 0300; 0600 to 0830; 0700 to 0900; 1045 to 1400; 1700 to 2030
9.930	CKL0	MONTREAL, CANADA; 1600 to 1800
9.940	GVZ	LONDON, ENGLAND: 1500 to 1730; 1800 to 2230; 0100 to 0500
9.950	X80Y	CHUNGKING, CHINA; 0630 to 1030
9.950	KRHO	HONOLULU, HAWAII; 0400 to 1100
9.950		MOSCOW, U.S.S.R.; 1100 to 1220; 2200 to 2235
9.950	WCDA	NEW YORK CITY; Caribbean beam, 1715 to 1745
9.950	KNBA	DIXON, CALIFORNIA; Hawaiian-Australian beam, 0245 to 0345
9.950	KCBA	DELANO, CALIFORNIA; Hawaiian-Australian beam, 0400 to 1000
9.950	KCBN	DELANO, CALIFORNIA; South American beam, 2000 to 2200
9.970	WRCA	NEW YORK CITY; Brazilian beam, 1900 to 2100; South American beam, 2115 to 2215
9.970	VUD4	DELHI, INDIA; 0125 to 0180; 0200 to 0400; 0730 to 0745; 0800 to 0830; 0845 to 1230; 2040 to 2245
9.970	WNRX	NEW YORK CITY; Brazilian beam, 1800 to 1800; 2000 to 2200
9.980	HVJ	VATICAN CITY; 1200 to 1330
9.980	XEQQ	MEXICO CITY, MEXICO; 0700 to 0045
9.980	VLB2	SHEPPARTON, AUSTRALIA; 0900 to 1100
9.980	EQC	TEHERAN, IRAN; 1200 to 1430
9.980	LRA1	BUENOS AIRES, ARGENTINA; 1600 to 2330
9.700	WLWR1	CINCINNATI, OHIO; South American beam, 1900 to 2400
9.700	KCBF	DELANO, CALIFORNIA; Japanese-Chinese beam, 0400 to 0900
9.700		FORT DE FRANCE, MARTINIQUE; 0900 to 1245; 1600 to 1010; 1730 to 2030
9.710		MOSCOW, U.S.S.R.; 2800 to 0730
9.720	PRL7	RIO DE JANEIRO, BRAZIL; 0430 to 0600; 1415 to 1445; 1500 to 2100
9.730	XG0A	CHUNGKING, CHINA; 0900 to 1030
9.730	CSW7	LISBON, PORTUGAL; 1900 to 2000
9.740	OTC	LEOPOLVILLE, BELGIAN CONGO; 1300 to 2015
9.750	KCBA	DELANO, CALIFORNIA; Philippine beam, 0400 to 0900
9.820		VIENNA, AUSTRIA; 2345 to 2030
9.820	GRH	LONDON, ENGLAND; 1215 to 1600; 1700 to 2300
9.830	COBL	HAVANA, CUBA; 0715 to 0045
9.860		MOSCOW, U.S.S.R.; 2200 to 0200; 0830 to 0930; 1000 to 1200
9.900	ZTJ	JOHANNESBURG, SOUTH AFRICA; 0315 to 0715
9.930	SVM	ATHENS, GREECE; 1300 to 1800
9.960	HCJB	QUITO, ECUADOR; 0545 to 0845; 1200 to 2230
10.000	WWV	WASHINGTON, D. C.; U.S. Bureau of Standards; frequency, time, and musical pitch; broadcast continuous by day and night
10.000	XG0L	FOOCHOW, CHINA; 0400 to 1000
10.228	PSH	RIO DE JANEIRO, BRAZIL; 1700 to 1800
10.730	VQ7L0	NAIROBI, KENYA; 0500 to 0800; 0830 to 0915; 0945 to 1100
10.780	SDB2	STOCKHOLM, SWEDEN; 1100 to 1720
11.040	C8W6	LISBON, PORTUGAL; 0900 to 1130; 1230 to 1500; 1600 to 1800
11.080		PONTA DEL GADA, AZORES; 1500 to 1600
11.630		MOSCOW, U.S.S.R.; 1930 to 0300; 0600 to 0800; 0930 to 1300
11.650	XTPA	CANTON, CHINA; 0400 to 0915
11.680	GRG	LONDON, ENGLAND; 0600 to 0845; 0700 to 0900; 1000 to 1130; 1145 to 1200; 1230 to 1430
11.690	XQRA	SHANGHAI, CHINA; 1830 to 2400; 0300 to 0930
11.700	HP5A	PANAMA CITY, PANAMA; 0700 to 2300
11.700	GVW	LONDON, ENGLAND; 2300 to 0030; 0600 to 0715; 0830 to 1015; 1130 to 1600; 1800 to 2300
11.700	SBP	STOCKHOLM, SWEDEN; 2000 to 2100
11.710	WLWS2	CINCINNATI, OHIO; South American beam, 1900 to 2400
11.710	VL63	MELBOURNE, AUSTRALIA; 0230 to 0345; 0100 to 0145
11.710	HE15	BERNE, SWITZERLAND; Tuesdays and Fridays, 1000 to 1130; Saturdays, 1350 to 1825
11.720		KIEV, U.S.S.R.
11.720	PRL8	RIO DE JANEIRO, BRAZIL; heard at 0500

## CIRCUIT TESTER

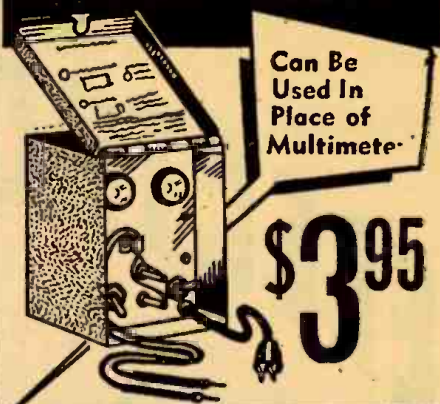

COMPLETE WITH INSTRUCTION BOOK

### TESTS:

1. Indicates AC and DC Voltages.
2. To Measure Resistances of Circuits.
3. Test for Fuses.
4. For Continuity of High-Resistance Circuits.
5. Test for Capacitors.
6. For Continuity and Measurement of Resistance of Circuits.

Small, compact unit contained in a strong metal box measuring approximately 5 1/2" long, 3 3/4" wide, 3 3/4" deep, weighs approximately 2 lbs. Test leads are provided. Power may be supplied to test unit from 115 to 130 volt AC or DC. Complete instruction booklet with each unit.

New. Shipped in Original Sealed Metal Container! Shipping Wt. 3 1/4 lbs. F.O.B. Chicago, Ill.

## SCHUH'S RADIO PARTS

1253 Loyola Avenue • Chicago 26, Illinois

## CONVERSION TELEVISION CABINETS



15" Television Set

**\$485.00**

Build yourself in two hours your own 15" or 20" Television Set from a new RCA latest Model 7" Television Receiver. We supply you with Cabinet, new RCA 13 Channel Television set complete with tubes, 15" or 20" Picture tube, Focusing Coil, Focus Control and diagram of changes.

Same, but with 20" Tube and Larger Cabinet ... **\$675.00**

World's First Specialized House in Television  
**ELECTRONICS SERVICE & SUPPLY CORP.**  
264 West 40th Street New York 18, N. Y.  
Phone PEansylvania 6-8730

# HOW'D YOU LIKE TO GET these famous Ghirardi Training Course Books FOR CHRISTMAS?

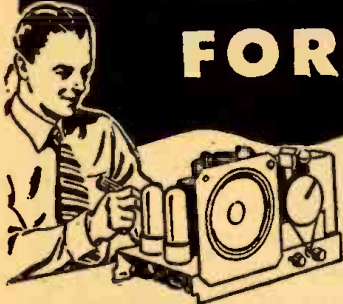

Friends or relatives are probably wondering what to give YOU this Christmas. They why not drop a hint that nothing would please you more than Ghirardi Radio-Electronic training course books? They'll appreciate the suggestion—and you'll appreciate the books every day of your life. What finer gift could you ever hope to receive than these giant training books that make it easy as A-B-C to learn basic Radio-Electronics and to troubleshoot and repair all kinds of radio and electronic equipment? And why not give these big books for Christmas to your own friends who are interested in radio?



## BEGINNERS! LEARN BASIC RADIO-ELECTRONICS

as fast as you can read!

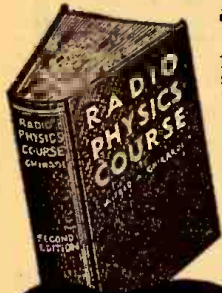

The most widely used radio training book in the world

Only \$5 for the entire course.

LEARN FAST!  
LEARN RIGHT!

No matter what phase of Radio or Electronic work you'd like to specialize in, you'll need the basic training that Ghirardi's 8 1/2 lb., 872-page RADIO PHYSICS COURSE book gives. More people have gotten their start from this giant book than any other book or course! On a survey among hundreds of radio service experts, engineers, instructors, etc., 9 out of 10 said that Ghirardi's RADIO PHYSICS COURSE is the finest, easiest-to-understand Radio-Electronic Training Course on the market. And you buy it for only \$5 for the complete course—on a money-back guarantee basis!

### 36 COURSES IN ONE!

RADIO PHYSICS COURSE is especially written for home study without an instructor. Nothing is omitted or condensed. Starting with a thorough, easily-understood foundation course in Basic Electricity, the book takes you step by step through the entire field of basic Radio-Electronics. Actually, RADIO PHYSICS COURSE gives you the scope of 36 complete courses in one big book. If broken into sections and sold as a series of lessons, you'd regard it as a bargain at \$50 or more. But you get it all at once! You learn as fast as you can read. Subjects that seem highly complicated in other courses are made crystal clear both in text and by over 508 clear pictures and diagrams. Mail coupon today. Remember, you don't actually risk a cent. OUR 5-DAY MONEY-BACK GUARANTEE IS YOUR ABSOLUTE PROTECTION.

## LEARN TO REPAIR RADIOS THIS FAST, EASY WAY!

You don't have to be an expert to make ordinary repairs in 4 RADIOS OUT OF 5! You don't need a lot of high-priced test equipment! Every receiver has its "weak" spots that give trouble first. Ghirardi has compiled case histories of these common troubles into a big 744-page RADIO TROUBLESHOOTER'S HANDBOOK. When you want to repair a set, just look up its make and model number. 4 times out of 5 the book tells you what the trouble is—and exactly how to fix it with a few simple tools. It's a service short cut that really works. The book pays for itself in time saved THE FIRST TIME YOU USE IT. Smart servicemen use it on every job.

### DO TWO JOBS ... IN THE TIME NORMALLY REQUIRED FOR ONE!

RADIO TROUBLESHOOTER'S HANDBOOK tells you what to do and exactly how to do it in repairing practically every radio model in use today. And that is just the beginning. It also contains the most complete, genuinely helpful Tube Chart you've ever seen. Dozens of pages contain I-F alignment peaks for over 20,000 superhets and data on I-F transformer troubles. Hundreds of additional pages contain tables, graphs, charts and service information to help you repair any radio ever made easier, AND TWICE AS FAST! You get the complete, 744-page, manual-size book for only \$5. See money-saving offer below!



Let this  
"AUTOMATIC  
TEACHER"

show you exactly  
how to repair  
OVER 4800  
RADIO MODELS

Fix Radios Without  
Costly Test  
Equipment!

## Get a complete PROFESSIONAL RADIO SERVICE TRAINING

At Home Without An Instructor

Ghirardi's famous 1300-page MODERN RADIO SERVICING is a complete, 1-volume course in PROFESSIONAL service methods of the kind that open doors to big money opportunities which only scientifically-trained men can grasp. It shows how to avoid guesswork by analyzing radio and other electronic circuits by professional methods. Explains how all basic types of radio test instruments work. Tells when, why, where and exactly how to use them. Shows how to troubleshoot both circuits and complete equipment; how to make repairs and replacements; how to analyze components—even how to run a successful radio service business of your own.

### Trouble Shooting Instruments and Repair

MODERN RADIO SERVICING is invaluable as a "refresher" course for men already in the radio service business—and it's worth its weight in gold to service beginners! Everything is explained so clearly it can easily be understood at home without an instructor. 706 clear illustrations and 720 Self-Test Review Questions speed up learning. Only \$6 for the big 4 lb. book—on our 5-DAY MONEY-BACK GUARANTEE. See money-saving offer in coupon.



Makes the  
hard jobs easy  
to do!

Trains You Scientifically for All Phases of Radio-Electronic Service.

### MONEY SAVING SPECIAL OFFER!

Let Ghirardi's RADIO TROUBLESHOOTER'S HANDBOOK save you time and money on common service jobs. Let his MODERN RADIO SERVICING train you for professional service work of all kinds! Get BOTH big books for only \$9.50 (\$10.50 foreign.) See Money-Saving Offer in coupon.

## 5-DAY MONEY-BACK GUARANTEE

Dept. RC-127, Murray Hill Books, Inc.,  
232 Madison Ave., New York 16, N. Y.

Enclosed find \$..... for which send me the Ghirardi Book(s) indicated below; or  send C.O.D. (no foreign C.O.D.'s) and I will pay postman this amount plus a small postal charge when he delivers my package. If the books are not entirely satisfactory, I'll return them within 5 days and you guarantee to refund my money.

- RADIO PHYSICS COURSE \$5 (\$5.50 foreign)
- MODERN RADIO SERVICING \$5 (\$5.50 foreign)
- RADIO TROUBLESHOOTER'S HANDBOOK \$5 (\$5.50 foreign)
- MONEY-SAVING COMBINATION OFFER! Both Modern Radio Servicing and Radio Troubleshooter's Handbook, only \$9.50 for the two (\$10.50 foreign).

Name .....

Address .....

City & Zone ..... State .....

# ESSE Specials!

## WILLARD LEAD ACID CELLS

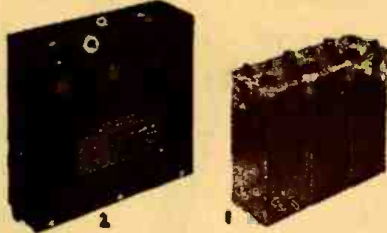

6 V. (In metal carrying case) ..... 4.00  
 6 V. (New) (Dry-charged) ..... 3.00  
 2 V. (New) (Dry-charged) ..... \$1.00  
 (Add electrolyte specific gravity 1.625) (Drug-store)

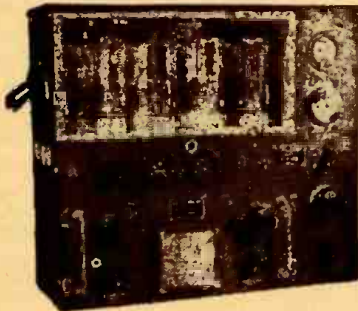

## BC-375E GE MOPA TRANSMITTER

with one tuning unit, choice ..... **\$17.50**



Antenna tuning unit BC-306A ..... \$3.95  
 Dynamotor PE-73C ..... 4.95



HS-33 Headphones (New) ..... \$1.60  
 HS-30 Headphones with cushions. Low impedance ..... 2.25

## (HRU) DC POWER SUPPLY

**\$59.50**



24-28 V. at 70 amp. 2000 W. gasoline engine generator with electric starter. Power supply which can be used to operate 24-28 V. equipment, to start air-

plane engines, to charge batteries, as a welding machine, lighting system, or for an amateur radio station. Height, 21 1/2"; Width, 17 1/2"; Length, 24 3/4" and weight, 115 lbs.

## TELRAD 18-A FREQUENCY STANDARD

Checks signals in the range of 100 Kc. to 45 Mc. with a high degree of accuracy. Self-contained power supply for 110, 130, 150, 220, and 250 V. 25-60 Cy. AC. Complete with tubes, dual crystal, and instruction book. Brand new. One of the best buys on the surplus markets ..... **\$24.95**



## BC-348 COMMUNICATIONS RECEIVER

**\$49.50**

6 bands, 200-500 Kc. and 1.5-18 Mc. 2 stages RF, 3 stages IF, BFO, crystal filter, manual or AVC. Complete with tubes and 24 V. dynamotor. These receivers have been thoroughly checked in our work-shop and found in excellent condition. BC-348, 110 V. AC power supply, including simple conversion instructions. Complete with tube ..... **\$8.95**



## COLLINS AN/ART-13 TRANSMITTER

A compact, light-weight, modern, high-powered transmitter. Frequency range 2-18.1 Mc. on any of its 11 autotune crystal controlled or master oscillator channels. December 1946 "Radio News" gives conversion data for converting 24 V. DC operation to 110-V. AC. All of these are in exceptionally fine condition, tested in our labs. Weight, 67 lbs. (Dynamotor included.) ..... **\$88.50**

All equipment advertised herein is unconditionally guaranteed to the customer's satisfaction to this extent: Return any item advertised within five days after delivery for full refund except transportation charges (both ways).

## SELSYN INDICATOR



Selsyn Indicator (operates from 15-25 V. 60 cy. AC supply)  
 5" model .... \$2.85  
 3" model .... 2.00



## BEAM ROTATING MOTORS

Motor with mounting plates, etc.  
**\$14.50**

Used to rotate your beam antenna  
 Motor only, 24-28V.  
**\$9.95**

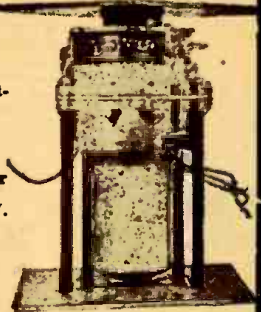

Power Supply (transformer 110 V.-30 V.) (New) ..... **\$4.95**

Telegraph keys (New) ..... **.45**

## ELECTOMODE HEATER

This is a heater used to heat the trucks of the CR-299 mobile units — which proved highly successful during the war. Operates from 110 V. AC or DC, 1,500 watts. Contains blower unit for forced air heating which can also be used for fan during warm weather. Thermostatically controlled with motor protect Thermotron. **\$29.50**



## CARBON MICROPHONES

T. 17 - B carbon microphones (hand-mike) (New)  
**\$1.35**  
 Headphone Extension Cords..... **.75**



**AIRCRAFT SUPPLIES**

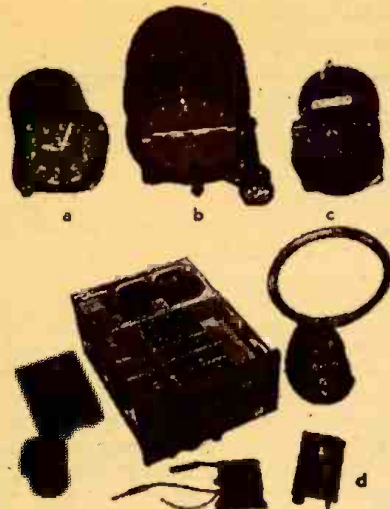

- a—Sensitive Altimeters ..... \$9.00
- b—Gyro-horizons ..... 7.50
- c—Magnetic Compasses ..... 6.00
- d—MN-26 Radio Compass (New) ..... 69.50
- SCR-269F Radio Compass (New) ..... 69.50

**LANDING LIGHTS**

Landing Lights, 24 V. retractable 600 watts.

**\$3.95**



**TUBE HEATERS**

Tube Heaters, 807's. Can be used for various purposes.

**.75**

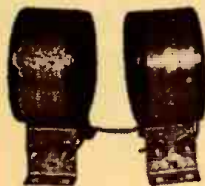

Westinghouse 0-500 Milliamps or 0-10 Milliamps meters, choice

**\$3.50**



- SCR-522 Transmitter and Receiver Closing Out) .....\$9.50
- RCA AVT-12A Aircraft Transmitters (Closing Out) ..... 3.00
- BC-929-A (Closing Out) ..... 4.00

**SETCHEL-CARLSEN RECEIVER BC-1206-C**

24-28 V. DC. Tubes, 3-14H7; 1-4R7; 2-8D7; 195-400Kc. Size, 4" x 4" x 6 1/2" wide, 4 lbs. With manual (New, in cartons)

**\$5.95**



**MG-149F INVERTER**

**\$5.00**

(Holtzer-Cabot Elect. Co.)

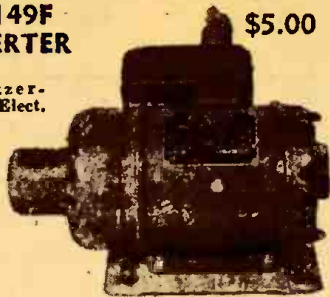

Input 24V. DC 36 amps. Output 115 V. 400 cy. AC, 500 V. A. Output at 90% P.F.



**PE-103 GENERATOR**

PE-103 Generator. Dynamotor power supply. Operates from 6 or 12 V.; delivers 500 V. DC at 160 Ma. (Brand New) ..... \$8.95

SCR-274N Command Set (ARC-5) components

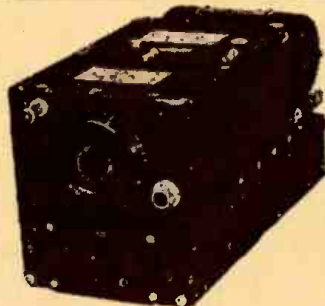

- Modulator with dynamotor .....\$4.75
- Receiver, 3-6 Mc. (BC-454-A) ..... 3.80
- Receiver, 190-550 Kc. (BC-453-A) ..... 4.75
- Receiver, 6-9.1 Mc. (BC-455-A) ..... 3.75

- Transmitter, 3-7 Mc. (BC-966-A) .....\$4.95
- Transmitter, 4-5.3 Mc. (BC-457-A) ..... 4.95
- Transmitter, 5.3-7 Mc. (BC-458-A) ..... 4.95



**ARB (CRV-46151) AIRCRAFT RADIO RECEIVER**

6-tube, 4 band, super-heterodyne receiver with built-in dynamotor. Designed for reception of MCW, (tone or voice) or CW with in the frequency range 195 Kc. to 9.05 Mc. We bought a carload of these in order to sell them at this price ..... \$16.50

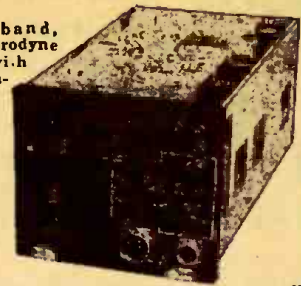

**GENERATOR CONTROL BOX**



**\$5.85**

Contains one 2 1/2" round 0-300 AC voltmeter and one 2 1/2" round 30-0-30 DC ammeter. Also plug, switch, relay, condensers and choke coil. (New.)

**RECTIFIER RA-63-A**

Battery charger or rectifier or power supply units. 110 V. 60 cy. input; 12 V. 8 amp. output. (New)

**\$19.75**



**BC-221 FREQUENCY METER**

Covers 125-20,000 Kc. Battery or 110 V. AC vibratorpack operated. Beautiful equipment.

**\$39.95**



**TWO BAND BC-222 WALKIE TALKIE**

Operates 28-38 and 38-52 MC. Ideal for use as ten meter field units. Less accessories and tubes. (Uses type 30 and type 33 tubes)

Price .....\$19.50  
 Battery pack for above unit \$5.00 (New)  
 Hand set for above unit \$5.00 ea. (New)  
 Telescoping antennae \$2.95 ea.

ADDRESS DEPT. RC-12



**Radio Co**  
 130 W. New York St.  
 Indianapolis 4, Ind.

Unless Otherwise Stated, All of This Equipment Is Sold As Used  
**CASH REQUIRED**  
**WITH ALL ORDERS**  
 Orders Shipped F.O.B. Collect

# TRANSVISION

## 7" TELEVISION KIT with COMPLETE FM RADIO



**COVERS  
ENTIRE  
FM BAND  
(87.5 TO  
108.5 MC)**

### TRANSVISION 7" De Luxe Television Kit with FM Radio Receiver

Easy to assemble; no technical knowledge required. 18 tubes and picture tube. Folded Dipole Antenna and 60 ft low-loss lead in cable ..... LIST \$199.00  
7" Standard Television Kit ..... LIST \$169.00  
Table Model Cabinets for above ..... LIST \$32.50

### 10" CONVERSION KIT

with 10" Electromatic Tube and Directions. Converts any 7" Television Kit to 10" size ..... LIST \$69.00  
Also 10" STANDARD TELEVISION KIT. LIST \$239.00  
Table model cabinet ..... LIST \$35.00

### TRANSVISION PICTURE BLOW-UP LENS

Brilliantly enlarges any 7" television picture to equivalent picture of 10" television set.

Has adapter arrangement for Transvision Panels and cabinets. Optically ground and polished to high accuracy. Plastic, gives 50% greater light transmission than equivalent glass lens.  
LIST ..... \$19.95



### TRANSVISION 8-TUBE FM RADIO RECEIVER

Covers entire FM Band (87.5 to 108.5 mc)

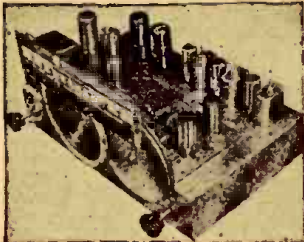

No technical knowledge required for assembly. Makes an FM Radio Receiver worth 2 to 3 times cost of Kit. Model FM-1 8-tube FM Radio Receiver Kit with 10" Speaker and Tubes ..... LIST \$64.95

### FM CONVERSION KIT

enables you to incorporate a complete FM Radio into your present television receiver ..... LIST \$29.95

### HIGH-FIDELITY FM TUNERS

Model FMF-2 ..... 2-tube Tuner Front End (less tubes) ..... LIST \$21.65  
Model FMF-3 ..... 3-tube Tuner Front End (less tubes) ..... LIST 30.75  
Model FM-107R ..... 3-Tube IF Amplifier Kit (less tubes) ..... LIST \$21.65  
Model FM-107 ..... 3-Tube IF Amplifier Kit (less tubes) ..... LIST 41.20

All prices fair traded. All prices 5% higher west of the Mississippi River.

See your local distributor, or for further information write to:

**TRANSVISION INC.** Dept. R. C.  
385 North Ave., New Rochelle, N. Y.

## FM AND TELEVISION DESIGN

(Continued from page 38)

to a double superheterodyne circuit is shown in Fig. 7. The unusual feature of this circuit is the use of a single oscillator (Colpitts) for both mixing operations.

There are 3 coaxial tuners: C1T1, T2C2C3, and C4T3. C1 and T1 tune over the 88-108-mc range. They receive the input signal and apply it to the grid of V1 ( $\frac{1}{2}$  7F8). At the same time V1, using C3, C2, and T2, is operating as a Colpitts oscillator and generating a voltage which mixes with this input signal. For a station signal of 100 mc., the oscillator frequency is 47.85 mc. The difference between these 2 frequencies is 52.15 mc, and T3 and C4 are resonant to this frequency. The 52.15-mc signal now mixes in V2 with the 48.75 mc of the oscillator, producing a difference frequency of 4.3 mc, and i.f. in this particular receiver. The signal is thus lowered twice to reach the final 4.3-mc value.

**RCA Transmission-Line Tuner:** A tuner using what might be termed a parallel-wire transmission line is found in the latest RCA television receivers. (See Fig. 8.) A television receiver must be capable of tuning to each of the 13 television channels; so the line is constructed to act as a quarter-wave transmission

insure a sufficiently wide band spread.

The 10,000-ohm loading resistor is effective only in channel 9 and all lower channels. Above channel 9 the resistor is shorted out by the shorting bar. In the 4 highest frequency channels, sufficient band spread can be achieved without the use of this loading resistor.

It is obvious that in tuners of this type, each coil switched into the circuit depends upon the coils which are already in the circuit ahead of it. Hence, in alignment, we start with the highest channel and adjust coils progressively until the lowest frequency channel is reached. In the r.f. amplifier line, adjustments can be made only at the beginning of the 7 higher channels and at the beginning of the 6 lower channels. The same number of adjustments are available for the converter line. If the circuits are functioning properly, all of the remaining channels will fall into line. In the oscillator, adjustments are provided for each channel. This is necessary because a single frequency is generated in each instance and it must be accurately set.

In the tuner of Fig. 8, double triodes are used in each r.f. circuit. In the r.f. amplifier, the transmission line lead-in

(Continued on page 71)



Fig. 9—Permeability tuner used by Zenith.

line for each channel. To vary the effective length of the line, a movable shorting bar is used. Adjustable coils L25 and L26 provide the correct length of line for the highest channel, No. 13. Its frequency range is from 210 to 216 mc. For each lower channel, the shorting bar is moved progressively down the line. As we insert more inductance into the line, the frequency becomes proportionately less. Between channels 6 and 7 there is a frequency gap of 86 mc. Channel 6 extends from 82 to 88 mc; channel 7 from 174 to 180 mc. Adjustable coils L11 and L12 are inserted into the line to make the transition between these 2 channels.

The inductances which compose the line are of 2 types. From L11 to L26 inclusive, each coil is a small nonadjustable silver strap between the switch contacts. Each strap is cut to represent a 6-mc change in frequency. Coils L1 to L10 inclusive are wound in figure-8 fashion on fingers protruding from the switch wafer.

Each of the 3 input circuits, the r.f. amplifier, the oscillator, and the mixer, have the same type of construction. The mixer is coupled to the r.f. amplifier through C10, C12, C13 and a single turn of link coupling. The coupling is close, purposely so, to produce at least a 4.5-mc band pass on each of the 13 channels. Within the mixer itself, a 10,000-ohm resistor is shunted across the circuit to

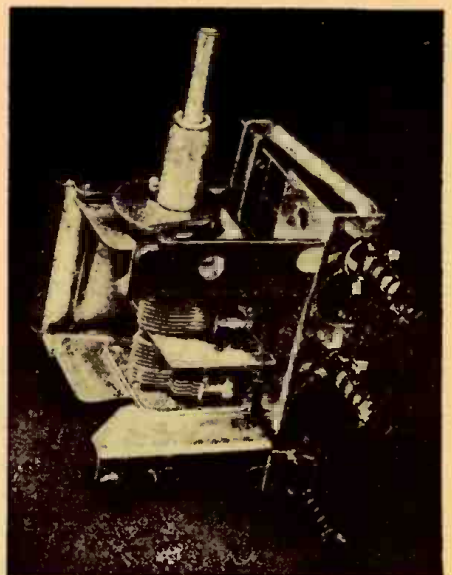
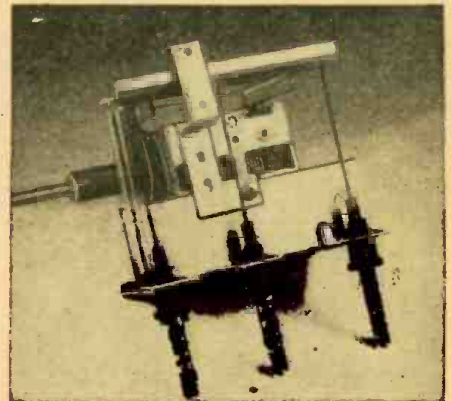
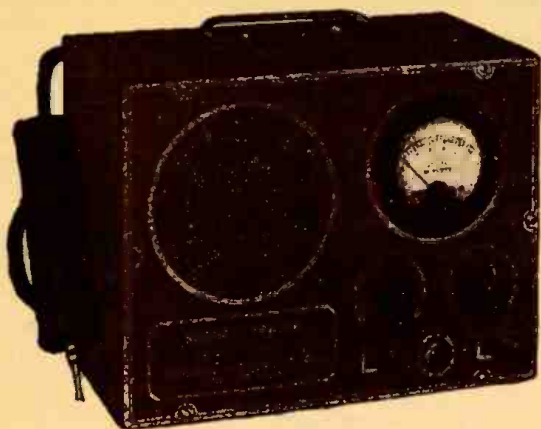

Fig. 10—AM-FM tuning assembly, two views.

# BUILD YOUR OWN SIGNAL TRACER

## and Save!!



MODEL CA-12 Kit includes ALL PARTS assembled and ready for wiring, circuit diagram and detailed operating data for the completed instrument.

**\$24<sup>85</sup> NET**

We are pleased to announce we have obtained an exclusive franchise to distribute the well known Model CA-12 Signal Tracer in kit form. The Model CA-12 sells regularly for \$34.85, here is your opportunity to save \$10 with the added advantage of complete familiarity of design and operation made possible when you build your own instrument.

**THE MODEL CA-12 KIT COMES COMPLETELY ASSEMBLED.** Can be wired in 30 minutes. Components and circuit guaranteed to meet the following:

### FEATURES:

- ★ COMPARATIVE INTENSITY OF THE SIGNAL IS READ DIRECTLY ON THE METER—QUALITY OF THE SIGNAL IS HEARD IN THE SPEAKER.
- ★ SIMPLE TO OPERATE—ONLY ONE CONNECTING CABLE—NO TUNING CONTROLS.
- ★ HIGHLY SENSITIVE—USES AN IMPROVED VACUUM-TUBE VOLT-METER CIRCUIT.
- ★ TUBE AND RESISTOR CAPACITY NETWORK ARE BUILT INTO THE DETECTOR PROBE.
- ★ BUILT-IN HIGH GAIN AMPLIFIER—ALNICO V SPEAKER.
- ★ COMPLETELY PORTABLE—WEIGHS 8 POUNDS—MEASURES 5 1/2" x 6 1/2" x 9".

20% DEPOSIT REQUIRED ON ALL C.O.D. ORDERS

**GENERAL ELECTRONIC DISTRIBUTING CO.** Dept. RC-12, 98 Park Place  
NEW YORK 7, N. Y.

### NAVY CRV-4615 AIRCRAFT RADIO Receiver

INCLUDING  
CASE

**\$16<sup>50</sup>**

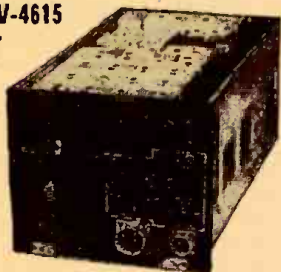

Four bands, including broadcast (1195-9,050 KC). Circuit is six-tube superheterodyne with mechanical band change or remote operated electrical band change. Remote band change and tuning controls included, making this set readily adaptable to mobile ham use. Powered from self-contained 24 V. DC dynamotor.

The sets are complete with tubes, mounting rack and remote controls. No cables.

### ARC-4 TRANSMITTER and RECEIVER

INCLUDING  
CASE

**\$19<sup>75</sup>**



Operates on any of its 4 predetermined crystal controlled frequencies in the range of 140 MC. Complete with tubes, remote control, junction box, shock mounting base and connecting plugs. This unit is ideal for amateur UHF or mobile telephone. Operates from self-contained 24 V DC dynamotor. 12 V available upon request.



### RADIO ALTIMETER APN/1

A complete 460 mc. radio receiver and transmitter which can be converted for ham or commercial use. Tubes used and included: 4-12SH7, 3-12SJ7, 2-6HG, 1-VR150, 2-955, 2-9004. Other components such as relays, 24 V dynamotor, transformers, pots, condensers, etc., make this a buy on which you can not go wrong. Complete as shown in aluminum case 18" x 7" x 7 1/2".

**\$8<sup>95</sup>**



### OXYGEN TANKS

These oxygen tanks, removed from surplus aircraft have a capacity of 500 lbs. pressure, Type D2, with complete regulator assembly. Size of tank 22"x5".

**\$8<sup>95</sup>**

FOB INDPLS.

TERMS: CASH WITH ORDER  
Address Orders to Dept. B

**AMERICAN SURPLUS  
PRODUCTS CO.**

537 N. CAPITOL AVE.  
INDIANAPOLIS, IND.

### NEW WILLARD RECHARGEABLE STORAGE BATTERY



New 6 Volt battery in spill-proof clear plastic case, housed in metal case for easy mounting. Applicable for a wide range of uses where battery power is needed. Shipped dry. Uses standard battery electrolyte available everywhere.

Price, each .....	\$4.00
Lots of Ten .....	3.35
Without metal case, each .....	3.00
Lots of Ten .....	2.85

### Brand New SCR-625 MINE DETECTOR

Attention, Prospectors, Miners,  
Oil Companies, Plumbers, Etc.

#### Metallic Objects Only

Used by the Army to detect buried metallic mines, its private use suggests the location of underground or underwater pipes, cables and ore bearing rock, the location of metallic fragments in scrap materials, logs, etc., and the screening of personnel in plants for carrying of metallic objects.

New, complete in original overseas packing container. Originally sold by War Assets for \$166.00.

The U. S. Forestry Service has recommended procedure for using the SCR-625 Mine Detector to find concealed metal in tree logs and other timber products.

**\$55<sup>00</sup>**

# RADIO and ELECTRONIC SUPPLIES for ALL PURPOSES

## RADIO KITS

All kits have been designed by a reputable radio engineer with a background of many years experience with some of the leading manufacturers in the radio industry. The kits contain all the required parts except wire and solder for their construction into an efficient working unit comparable with the best post-war type of units. The simplified diagrams furnished make it possible for any radio student experimenter, or amateur to construct these kits.

### FIVE TUBE AC-DC SUPERHET KIT:

Furnished in a brown plastic cabinet of artistic design, cabinet size (9"x5"x6"). Variable condenser tuned with 2 double tune I.F.'s. Tubes used: 1-12SA7, 1-12SQ7, 1-12SK7, 1-35Z5, and 1-50L6 ..... PRICE **\$12.45**  
(Including 5 Standard Tubes)

### SIX TUBE 3 WAY PORTABLE KIT:

For operation on 110 volt AC or DC and battery. Superheterodyne circuit. Full vision dial. High gain loop. Cabinet of Blue Acroplane cloth finish, size 12 x 9 1/2 x 7". Tubes used 1A7, 1H5, 3Q6, 117Z6 and 2-1N5. PRICE ..... **\$13.75**

Not including tubes. Extra for kit of Tubes 3.75

### POCKET SIGNAL GENERATOR

RCP Model 710 Genuine Pocket Signal Generator. This instrument can be conveniently carried in a pocket, measures only 3x6x2 1/4" and weighs 2 lbs. Indispensable for on the job service work. With this instrument you can do a complete and aligning job on a broadcast receiver. Broadcast band alignment is provided for by fixed frequencies of 1500 KC and 550 KC. Intermediate frequency alignment is provided for by fixed frequencies of 455 and 465 KC. PRICE **\$17.95**

### THREE TUBE PHONO AMPLIFIER

An assembled unit ready for installation using tone and volume control and six feet of rubber cord ..... PRICE **\$2.95**  
(Not including Tubes)

### PHONO OSCILLATOR

Wireless phono oscillator transmits recording for crystal pick-ups or voice from carbon mike through rough radio without wires. Can also be used as an intercomm by using P.M. speaker as mike. Price (excluding tubes) .. **\$2.95**

### TELEVISION-CATHODE RAY HIGH VOLTAGE

2000 volt D.C. Power Supply

For an unbelievable low price, we can supply a completely filtered television or cathode ray 2000 volt D.C. power supply. Why bother with bulky and dangerous 60 cycle supplies or expensive R.F. power supplies when you can purchase a complete 2000 volt D.C. power supply (not a kit), ready to plug into the 110 volt A.C. power line. The ridiculously low price has been made possible by a fortunate purchase of high quality components. These units are brand new, completely tested and guaranteed. Here are the advantages:

- Low cost
- 2000 volts D.C. at 1 ma.
- Safe
- Small size
- Completely wired and tested
- Ready to connect to your television set or other equipment
- Will operate from 110 volts. 25 to 60 cycles.

PRICE ..... **\$7.95**

At small additional cost, we can furnish these units to operate from 110 or 220 volts D.C. lines or 220 volts A.C.—any frequency. Write for quotation, giving us your requirements.

### PORTABLE SIGNAL GENERATOR

Army Type 1-198-A

Frequency range 8-15 mc. Fully stabilized. Can readily be converted to Broadcast Band or any other frequency range by simply changing one coil. Attenuation consists of 4 position multiplier switch with variable potentiometer. Internal modulator can be turned off. Manufactured by Monarch. Excellently designed, fully assembled. Operates from 110 volts 60 cycle line ..... **\$11.95**

### A SCIENTIFICALLY DESIGNED SCRATCH FILTER

Resonated at approximately 5000 cycles effectively reducing objectionable needle scratch without altering the brilliancy of reproduction. Contains a HI-Q SERIES resonated circuit. Tested by means of an audio oscillator and an oscilloscope to give 22 1/2 db attenuation at 5000 cycles with very low signal loss at low frequencies. Attenuation may be regulated by means of a SPECIAL MINIATURE gain control.

EASY TO ATTACH

Just two wires to clip on to the leads coming from phone pick up. Compact. Price ..... **\$1.65**

### MAGNETIC RECORD CUTTER and PICKUP

PRICE **\$2.95**

All Prices are  
F. O. B.  
New York City

## RADIO DEALERS SUPPLY CO.

135 Liberty St., New York, N. Y.

Available, a large stock of radio parts, test equipment, etc., at attractive prices. Write for free catalogue.

WE SHIP  
ANYWHERE  
PROMPTLY

## 3 WAYS TO BE AHEAD in Buying Test Equipment

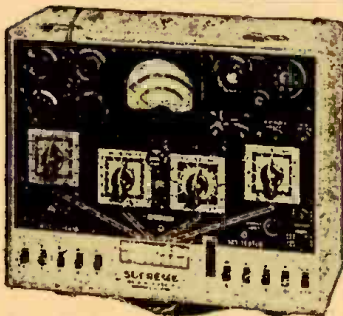

Model 599-A Tube and Set Tester

**SPECIFICATIONS:**  
DC Volts — 5 ranges 0/6/15/150/600/1500 volts, 1000 ohms per volt.  
AC Volts — 3 ranges 0/15/150/600 volts.  
DC Current — 3 ranges 0/6/60/600 milliamperes.  
Output Volts — 0/15/150/600 volts.  
Ohmmeter — 4 ranges 0/200/20,000 ohms and 0/2/20 megohms.

Condenser Checker—Ohmmeter provides fast method of checking leakage of both paper and electrolytic condensers.  
Battery Tester — Tests most commonly used dry portable batteries of 1.5/4.5/6.0/45/90 volts. English reading "Replace-Good" scale.



WRITE FOR  
NEW  
CATALOG

**SUPREME INSTRUMENTS CORP., Greenwood, Miss., U.S.A.**

Export Department: THE AMERICAN STEEL EXPORT CO., Inc.,  
347 Madison Ave., New York 17, N. Y., U.S.A.

- 1 BUY ACCURACY
- 2 BUY DEPENDABILITY
- 3 BUY SUPREME-ACY

Ask your nearest SUPREME jobber for a demonstration of Model 599-A Tube and Set Tester (above), Model 561-AF & RF Oscillator, Model 546-A Oscilloscope, Model 592 Speed Tester. Ask to see the complete line of SUPREME equipment.



Tube Testing — Circuit incorporates proven and modernized emission circuit. Checks for short, leakage, and noise tests between elements.  
Power Supply — 100-133 volts—50/60 cycles. Special voltages and frequencies on request.

## RADIO-ELECTRONIC PATENT

(Continued from page 52)

ated and may be reflected from any target in the path. If the reflected power is received during an instant when the superregenerator is not oscillating, there is no effect. However, if the pulses return just before the initiation of the pulses from the variable oscillator, they combine and cause the latter to start earlier than normally. The results are: lowered hiss (which is ordinarily present in a superregenerator) and a reduction of plate current. Therefore a meter in the plate circuit indicates when an "echo" is being returned.

To determine distance, the pulse frequency is varied for lowest plate meter reading (or minimum hiss). If the frequency is known, the distance can be calculated. The pulsed oscillator dial may be calibrated directly in terms of this distance, either by experiment or calculation.

### AUTO RADIOS

Six or seven volts from a filament transformer rated at about 10 amperes can be used for testing auto radios if they use nonsynchronous vibrators in the power supply. Remove the vibrator and ground one side of the primary winding of the power transformer and replace the speaker with a PM unit. Connect the secondary of the filament transformer in series with the primary of the power transformer.

JOSEPH FRIEDERER,  
Worcester, N. Y.

(This method should not be used for prolonged periods since many automobile power transformers are designed to operate at almost twice the standard line frequencies.—Editor)



is terminated in 300 ohms of resistance (the two 150-ohm series resistors), its characteristic impedance. T1 prevents signals at frequencies lower than the television channels from passing through the set. It is essentially a simple high-pass filter. C3 and C4 are small neutralizing condensers, designed to prevent the tube from oscillating. This tendency may arise in the upper television channels. Similar condensers are not required in the converter because here the grid and plate circuits are tuned to different frequencies. All 3 stages operate their tuned circuits in push-pull.

**Permeability Coil Tuning:** We have covered every type of tuner but the permeability coil tuner. In this unit, an iron core is moved up and down in a coil, with a corresponding inductance variation. This method of changing frequency has recently become popular in standard AM broadcast sets and is certain to find wide acceptance in the FM receiver.

The design used in Zenith AM-FM sets is shown in Fig. 9. Four parallel wires are used to overcome the difficulty of obtaining by using a single wire, the necessary inductance change (and hence frequency change) for a complete travel of the core within the distance allotted to it on the dial. If we take a coil formed by using a single strand of wire and increase the width of that wire, we find that for a given change in core displacement, a greater tuning variation is obtained. A similar result may be achieved by winding the coil with parallel wires.

Another unusual constructional feature of the coil is the uneven spacing of the turns. If the winding is made uniform in pitch, the tuning curve for the permeability unit is found not to be linear. The nonlinear slope at each end occurs because the incremental inductance variation is maximum when the leading edge of the coil core is in the center of the coil and minimum at the start or finish of the core travel. To straighten out the curvature at the ends of the characteristic, the coil turns are bunched at the ends and spread out in the center. The inductance variation with core movement is thereby increased at each end and decreased at the center. To further insure that the tuning curve will be linear, the coil and core lengths are made longer than necessary and only part of the complete tuning curve is used. The core, with this construction, is never out of the coil turns.

Any difference in tracking is compensated for by a single initial advance or retraction of the iron core of each coil.

A photograph of the entire assembly is shown in Fig. 10. The standard AM broadcast frequencies are tuned by the conventional ganged condenser. For the FM portion of the set, the antenna, mixer, and oscillator coils are mounted on a bracket fastened to the side of the ganged condenser.

# TRAIN FOR GOOD PAY IN A FIELD THAT ISN'T CROWDED!

**New! Different! Easy to Understand! Opportunities Everywhere!**

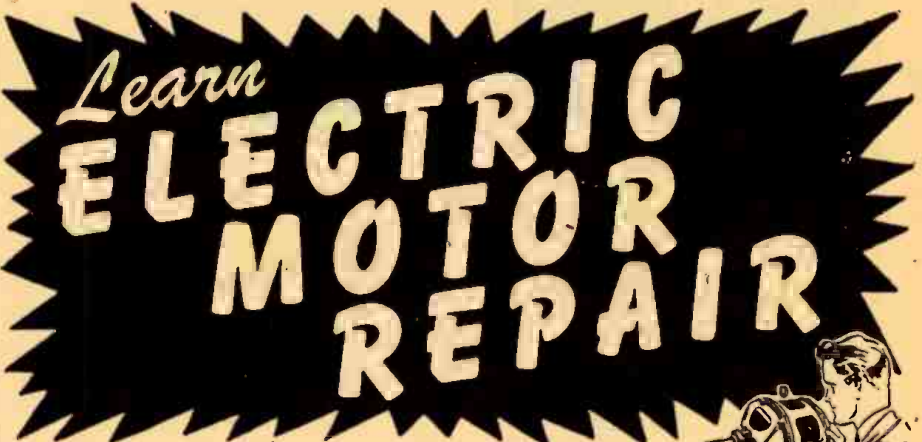

**This Big Training Course Book Teaches You Every Step of the Work . . . for only \$5 complete**

Get where the real profits are—in Electric Motor Repair! There are more motors than any other type of electrical equipment. Good repair men are scarce and well paid. Now, for the first time in modern training history, you can learn this work at home, QUICKLY, in spare time, for only \$5. **ELECTRIC MOTOR REPAIR**, the big new 570-page training course book, is especially written for beginners. No previous experience needed. Start training now for better pay and big opportunities in a field that isn't crowded.

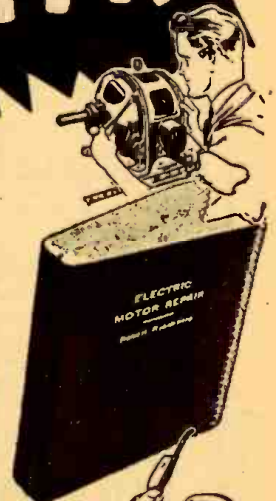

**Based on this big book alone, you can TRAIN FOR PROMPT, PROFITABLE SERVICE ON PRACTICALLY ANY MOTOR IN COMMON USE!**

**570 PAGES . . .  
OVER 900  
ILLUSTRATIONS**

**ELECTRIC MOTOR REPAIR BOOK** teaches you the work from the very beginning. Over 900 specially prepared diagrams and pictures make your training easier and **TWICE AS FAST**. You learn every step of the work from motor trouble diagnosing to repair—from simple motor cleaning and adjustments to complete rewinding. Covers every type of motor in common use and **BOTH** mechanical and electrical motor control systems. Quick reference guides show exactly how to handle specific jobs. When a certain type of motor comes in for repairs, just look it up. The book shows exactly what to do, exactly how to do it. Duo-Spiral Binding divides book into 2 sections so text and related illustrations can be studied together.

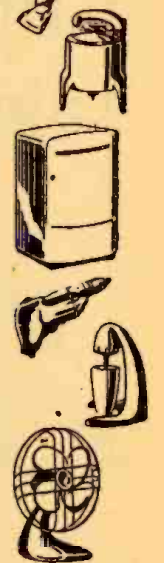

**"BORROW" IT AT OUR RISK!**

**ELECTRIC MOTOR REPAIR** is the ideal, easy-to-understand book for beginners. Hundreds of motor repair shops use it for training new helpers and for daily use at the bench. Send coupon today! Practice from **Electric Motor Repair** for 5 full days. If not more than satisfied—if you're not fully convinced that, at least, here is the ideal training for YOU, just send the book back. Every cent of your money will be cheerfully refunded **AND NO QUESTIONS ASKED!**

**5-DAY MONEY-BACK GUARANTEE**

**YOU CANNOT LOSE!**

Dept. RC-127, Murray Hill Books, Inc.,  
232 Madison Ave., New York 16, N. Y.

Send me a copy of "ELECTRIC MOTOR REPAIR" for which I enclose \$5 (\$5.50 foreign); or  send book C.O.D. for this amount (No foreign C.O.D.'s) and I will pay postman \$5 plus postal charges when he delivers it to me. If book is not satisfactory for any reason, I'll return it within 5 days and you guarantee to refund my \$5.

NAME .....  
ADDRESS .....  
CITY & ZONE ..... STATE.....

# NEW SERIES 16

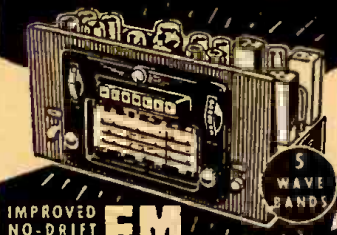

IMPROVED NO-DRIFT **FM**  
in the Sensational 1948  
**MIDWEST RADIOS**

Separate Chassis Like This Powerful Series 16 AM-FM models or Beautiful Radio-Phone Consoles Available

## The SYMPHONY GRAND



RADIO-PHONOGRAPH  
AM-FM CONSOLE

A truly magnificent instrument that offers new, improved No-Drift FM, 5 Wave Bands, Automatic Intermit Record Changer that handles both 10" and 12" records, 14 1/2" Panasonic Speaker, and exclusive Midwest Tri-Magnadyne Coil System and Color-Ray Tone Selection. Luxurious cabinets. Other Console and Table Models with Series 16, 12, and 8 Chassis.

EASY TERMS

30 DAYS TRIAL

SEND FOR FREE Catalog

BUY DIRECT FROM FACTORY AND SAVE!

FILL IN COUPON AND MAIL TODAY OR JUST SEND YOUR NAME AND ADDRESS ON A POSTCARD

**MIDWEST RADIO CORPORATION**  
Dept. 22-12, 909 Broadway, Cincinnati 2, Ohio  
Please send me your new FREE 1948 Catalog.

NAME.....  
STREET.....  
CITY.....ZONE.....STATE.....

## HIGH, WIDE and ECONOMICAL\*

*It's the new*

# UNIVERSITY TWEETER

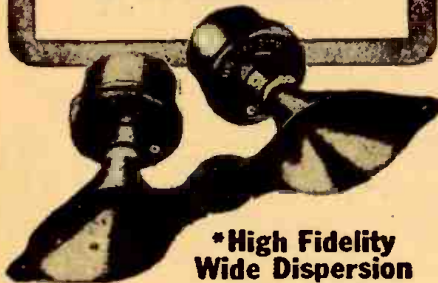

**\*High Fidelity  
Wide Dispersion  
Low Cost**

It's the new UNIVERSITY Tweeter! Extends the range of any cone speaker to 13,000 cycles. Install it in your present equipment by merely attaching two wires to the voice coil terminals of the existing speaker, without creating any electrical unbalance. Simply connect, listen and enjoy. Twin units provide 100° horizontal and 50° vertical dispersion. Three models to choose from—walnut cabinet type, and single or dual unmounted types. Priced from \$20.00. Write today for complete details to UNIVERSITY LOUDSPEAKERS, INC., 80 South Kensico Avenue, White Plains, N.Y.

*University Loudspeakers*

# SELLING A RADIO

By JACK KING

WHEN the prospective purchaser of a radio receiver enters the store he has an idea of the kind of set he wants. In most cases that idea is vague and general. His mind is not made up. The salesman's business is to sell him a radio of a type that will satisfy his needs and will make him a regular customer for other electrical equipment.

The first consideration with most people is price. More fortunate people may be interested first in quality and second in cost, but they also expect to get full value for every dollar spent. Selecting a good radio from among the many types and brands available is not, for the non-technical and inexperienced customer.

The price-minded customer is well aware that price is generally a clue to quality. Both radio dealer and customer have been beset with low-priced radios which offer aurora borealis dials, automatic frequency control, silent a.v.c., a battery of loudspeakers, and multicolored pilot lights. Faced with such an array of talking points, the wise salesman will do well to point out that, of several sets at the same price level, the one with fewer special features is likely to be a better buy. Common sense indicates that costs must rise as the number of gadgets is increased. Flimsy soldering, hasty assembling, and decrease in the quality of individual components may be expected in the elaborate set which sells at a bar-

gain price. There is absolutely no percentage in handling these sets, for the kickbacks and ill will engendered by frequent breakdowns and poor operation will more than eat up any profit gained in the original sale.

After price, the customer usually has in mind a generalized picture of the type of set desired—whether plastic or wood table model, console or combination. Women especially are impressed with appearance and styling. They want the radio to fit harmoniously into its surroundings. They may be shopping for a receiver for Junior's or the maid's room, living room, or kitchen.

In some cases the woman of the house may be looking for a piece of furniture in which the radio—though important—is of secondary significance to her. To the technician used to thinking of a radio as a chassis this may seem illogical. Actually it is good sense. She is thinking of a room as a whole and of the room as part of the home picture, and seeking to integrate into that picture a new element—the radio receiver in its cabinet. A console radio may be one of the most important features in a living room, and if well and suitably styled will add greatly to the room's appearance.

If the purchaser is a music lover, the salesman has an opportunity to sell a receiver priced in the higher range, particularly an FM set. For adequate reproduction a large speaker or combination

ED'S RAD  
ELECTRIC REPAIR  
RADIO FM TELEVISION  
ED'S RADIO SERVICE  
CALLEY

Suggested by J. B. Calley,  
Red Bank, N. J.

"Come on in and get spliced."

of speakers, with adequate baffling, is a necessity. Fortunately, the music lover is quick to recognize even small differences of quality, and equally quick to see the advantage of paying more for a radio that will give him the quality he wants.

Few prospective buyers take the trouble to look inside radio cabinets. If a chassis is well made and of good size, with the parts not crowded and jammed together, it is worth the salesman's while to call that fact to the customer's attention. Such a chassis speaks of quality and workmanship and the customer is usually quick to see the point.

The man of the house is usually more technically minded than his wife, sister, or mother. He is the one who will be interested in such items as chassis construction. He may also be the victim of the gadgeteer. While many people like such conveniences as push-button tuning, it is well to point out that such tuning adds to the cost of a receiver. In an automobile set, the additional cost is well justified, since the push-buttons permit tuning without taking too much of the driver's attention away from the all-important job of handling the car. There is no such problem in the home, and push-buttons are simply a convenience.

The demand for automatic record players is a mystery to the average radioman. It is no great task to change a record, but to avoid that task the owner of a record player is willing to trust his fine records to an automatic unit which too often goes berserk and starts destroying them. He is willing also to pay the increased maintenance costs and tolerate the loss of service during the periods when his player is in the repair shop. The radio dealer can do little to change human nature, but if any manufacturer *should* eliminate the changer and substitute a one-record type of player, the salesman should assist him by pointing out its simplicity and ruggedness of construction as well as the freedom from the annoyance and cost of excessive maintenance.

Cost is tied in with the pickup used in record changers. The crystal is light and cheap, but is subject to mechanical shocks during operation and is relatively fragile and delicate. More ruggedness and much better quality are claimed for many of the new pickups. Some of these are magnetic and others are based on various principles. As they are new, the radioman will have to use good sense and theory as well as drawing on such experience as he gains with these pickups when making recommendations to customers.

There is little point in recommending a receiver with short wave to the average customer, as most people are not interested as soon as they find that the quality of short-wave reception is not equal to that from a good local. This is not true of certain classes of buyers. Some people who have short-wave bands on their receivers become short-wave fans. They may then become good prospects for communications receivers. Many people of foreign extraction are

*(Continued on page 76)*



Make **YOUR SHOP** a  
modern, profitable

## SERVICE LABORATORY

Two things — and only two things — spell success or failure in radio servicing today. One is knowledge and skill. The second is instruments. McMURDO SILVER brings you the *Laboratory Caliber Electronic Test Instruments* which turn your shop into a modern service laboratory. Simple instructions make them easy to use. They are proved by thousands upon thousands of users. Compare value and prices and LCETI will be your selection, too.

**MODEL 906 FM/AM SIGNAL GENERATOR:** The basic need for AM, FM, and television servicing. 8 ranges calibrated  $\pm 1\%$  accurate, 90 kc. thru 210 mc. 0-100% variable 400 AM; 0-500 kc. variable FM sweep built-in. Metered microvolts; variable 0-1 volt Strays lower than \$500 laboratory generators. Only \$99.50 net.

**"VOMAX" UNIVERSAL V.T.V.M.:** The overwhelming choice of experts. 51 ranges, d.c., a.c., a.f., i.f., r.f., current, db., and resistance. Visual signal tracing to 500 mc. New 5" pencil-thin flexible r.f. probe. Only \$59.85 net.

**MODEL 904 CONDENSER/RESISTANCE TESTER:** Measures accurately  $\frac{1}{4}$  mmfd. thru 1,000 mfd.;  $\frac{1}{4}$  thru 1,000 megohms. Internal 0-500 V. variable d.c. polarizing voltage. Measures condensers with rated d.c. volts applied. Only \$49.90 net.

**MODEL 905 "SPARX" SIGNAL TRACER:** Time-saving visual and audible signal tracing; also tests phono pickups, microphones, speakers, PA amplifiers. Is your shop test-speaker, too. 20 thru 200 mc.; PM speaker; moins-insulated transformer power supply. Only \$39.90 net.

SEND FOR COMPLETE CATALOG. See these, and Silver communication transmitters, receivers, "Micromatch," Xtal-controlled VFO, pretuned frequency multiplier at your jobber.

OVER 36 YEARS OF RADIO ENGINEERING ACHIEVEMENT

*McMurdo Silver Co., Inc.*

EXECUTIVE OFFICES: 1240 MAIN ST., HARTFORD 3, CONN.  
FACTORY OFFICE: 1242 MAIN ST., HARTFORD 3, CONN.

# GIVE YOURSELF THE FINEST XMAS PRESENT EVER

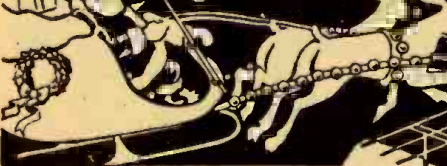

What better time to obtain the Test Equipment you've been wanting . . . especially when Walter Ashe's big "Surprise" Trade-In Allowance on your used Equipment means such really important money-saving! To avail yourself of this wonderful opportunity simply indicate your choice of new equipment in stock at Walter Ashe. Tell us what you have to trade. We'll follow with an offer that's sure to please you. Wire, write or phone today.

- TEST EQUIPMENT IN STOCK**
- |           |                      |          |
|-----------|----------------------|----------|
| Hickok    | Meissner             | Tripiett |
| Jackson   | McMurdo Silver       | R.C.A.   |
| Precision | Special Products Co. | Biley    |
| Simpson   | Industrial Equipment | Weston   |
| Waterman  | Cornell-Dublier      | Sprague  |
| DuMont    | Coastwise Electronic | Supreme  |
| Fetler    |                      | Superior |

Walter Ashe offers you EXTRA Special Deals on Top Condition—slightly used Test Equipment at savings that will amaze you! Tell us your requirements and we'll quote you on the deal of your choice of good-as-new merchandise now in stock. As always . . . a wide selection available.



**SURPLUS HEADPHONES**  
TYPE HS-16A ARMY SURPLUS phones. Canvas Web headband and long standard type cord. Packed in original overseas shipping boxes. Shpg. Wt. 3 lbs. **ONLY \$1.47**

**PE-103 DYNAMOTOR**  
WALTER ASHE still has that ideal power supply for your emergency set-up or mobile rig. Brand new in original overseas shipping crates, genuine SURPLUS PE-103 DYNAMOTORS that deliver 500 Volts D.C. at 160 Ma. with either 6 or 12 volt D.C. input. Get yours while the fast dwindling SURPLUS supply lasts. Shpg. Wt. 81 lbs. **ONLY \$9.95**

**TIME PAYMENTS AVAILABLE**

**FILTER CONDENSER**  
3 MFD. X 440 VAC filter condenser. Good for at least 1500 VDC. Shpg. Wt. 3 lbs. **\$1.50**

**S.B. CARBON HANDMIKE**  
Regular T-37B SURPLUS carbon mikes as used by the AIR FORCES during the WAR. 300 ohm. with push-to-talk switch, cord and plug. Brand New in original overseas shipping boxes. Shpg. Wt. 3 lbs. **ONLY 98c**

**THROAT MIKES**  
200 ohm CARBON, BRAND NEW. **ONLY 35c**

**FLOOR MIKE STAND**  
Black heavy base and 2 section black and aluminum tube. Extends to 60". The purchase of a manufacturer's closeout enables us to offer these \$6.54 value mike stands for **ONLY \$3.95** Shpg. Wt. 13 lbs.

**DUAL FILAMENT XFORMER**  
Two 5 volt windings at 5.25 Amps each and 115 VAO Pri. Shpg. Wt. 9 lbs. **\$1.95**

**IMPORTANT REMINDER!**  
Place your order NOW for the 1948 issue of ARRL "RADIO AMATEURS HANDBOOK" and EDITORS AND ENGINEERS "RADIO HANDBOOK"

**"DO YOUR XMAS SHOPPING EARLY"**  
To make sure of pre-Christmas delivery place your order now! Despite the holiday rush Walter Ashe will continue to ship the same day . . . often the same hour following receipt of your order!

**COMING! . . . AND SOONER THAN YOU THINK!**



The new, bigger, better Walter Ashe Catalog, featuring all that's new and best in Radio and Electronics. For "priority" delivery on your free copy ask to have your name placed on our mailing list.

ALL PRICES F.O.B. ST. LOUIS

**REMEMBER** your trade-in's worth more at the Walter Ashe store. So get Walter Ashe's offer before you make that trade.

**Walter Ashe RADIO CO.**  
1125 PINE ST. • ST. LOUIS 1, MO.

- |       |       |       |       |
|-------|-------|-------|-------|
| W0JWD | W0WTM | W0PGI | W0ULH |
| W9NRF | W0QDF | W0IYD | W0KES |

**ORDER NOW**

**NEW**

**"ELEMENTS OF MAGNETIC TAPE RECORDING and 999 APPLICATIONS"**  
by A. C. Shancy

**AVAILABLE AT ONLY 25¢**

**AMPLIFIER CORP. of AMERICA**  
338-10 Broadway New York 10, N.Y.

**RADIO PILOTED OCEAN FLIGHT**  
• (Continued from page 23)

This is wrong. In the All-Weather plane the flight control is completely within the plane and its only outside collaborator is the radio beam on which it is homing.

The trans-Atlantic flight last September was not the first major pilotless flight accomplished by the All-Weather C-54. In January 1947 it flew from New York to Wilmington, Ohio, and the following June it flew from Long Beach, California, back to its home base at Wilmington which is also the head-

quarters of USAF's All-Weather Flying Center.

The Automatic Flight is accomplished in 12 successive phases. The 1st is the pre-takeoff during which the plane is manually aligned with the runway. Second is the takeoff and the first phase under automatic control. When the aircraft reaches an altitude of 50 feet, phase 3 sets in automatically and the landing gear is retracted. This phase holds until an altitude of 1,000 feet is reached when the 4th phase takes over, automatically retracting the flaps. This phase continues until the plane reaches the previously determined cruise altitude.

The next 4 phases are navigational, during which the aircraft flies a ground course based on directional information from radio stations, magnetic lines of force of the earth and the air miles computer. In the trans-Atlantic flight there were two relay surface ships at sea on which the plane homed. After passing the second ship, the beam at Brise Norton brought the plane to its destination.

The 9th phase is the beginning of the descent to landing at destination, dropping to approach altitude over a pre-selected radio station (in this case the radio station at Brise Norton). The 10th phase becomes operative after the plane has descended below a 2,000 foot altitude. The flaps are dropped and landing gear lowered. Phase 11 occurs when the plane reaches the glide path and begins the final approach on localizer directional beam and glide path beam. The flight is concluded with phase 12 as the aircraft touches down on the runway and the brakes are activated.

Of all the steps in automatic flight, the application of brakes on landing is the only operation not electronically guided. They are applied by purely automatic but mechanical means. As the wheels touch the runway a mechanical process takes over, which gradually and effectively slows down and stops the plane. The stimulus for this operation comes from the momentum of the wheels as they start revolving on contact with the runway.

The brain for automatic flight is called the *master sequence selector*. It is located in the main cabin and is powered by an auxiliary gasoline generator. Navigation is controlled by 2 mileage counters and magnetic heading selectors. These instruments control the flight until the plane clicks off the pre-set number of miles on the predetermined heading. Final descent is at present geared to the AAF Instrument Low-Approach System (SCS-51 localizer and glide path).

The *master sequence selector* is used in conjunction with the A-12 Automatic Pilot and is essentially a coordinated system of aircraft controls whose functions are pre-set much in the same manner as a calculating machine. Various mathematical operations are set in the machine, then the total button is pressed and the answer is given accurately. Similarly all flight data is fed into the brain a button is pushed and the destination is reached safely despite the

most hazardous weather conditions.

Through the ingenuity of the U. S. Air Force it is conceivable that one day you can sit in your own private plane and instead of being confronted with a maze of dials and controls, to face a set of buttons marked, "New York," "Chicago," "Rochester," or "Philadelphia" . . . just as your push-button radio is marked. Press the button marked "Rochester" and you take off, fly to, and land there without touching a control, looking at a navigational chart or worrying about the weather. All the intricate operations of flying will be fed into the automatic flight controller before you take off. Indicative of the universal application of this device, is the fact that any broadcast station can be used as a homing beam.

According to Colonel Kelsey, "new doors are now open to aeronautical progress and toward practical and sane flying, regardless of weather, since the functioning of equipment is unaffected by outside weather conditions. It now becomes possible through radio and electronics to set up a flight at any point, over any route. This can be done simply by pre-selecting settings of automatic components."

Automatic Flight is just one of the many radio-electronic projects of the peacetime Air Force, directed at making all flying—civilian and military—safer and more economical. In this fascinating sphere of activities, hundreds of young men each month are taking advantage of the career opportunities in radio and electronics offered by the United States Air Force.

**"SUPER-R" FM RECEIVER**  
(Continued from page 35)

When the set has been built and wiring checked, it should be turned on and allowed to warm up. As the regeneration control is turned up, a loud "hiss" should be heard. When a station is tuned in, the hiss disappears.

You will find that the best reception is obtained when a very slight amount of hiss is allowed to remain in the background. If no hiss is heard when the set is not tuned to a station, the set is not operating properly. Check the wiring.

If C3 is not the proper value, the hiss will sound like a hum, feedback, or roar; and the value should be varied till best results are obtained.

No external ground of any kind may be used with the set under any circumstances. If you must experiment, connect the ground through a 50- $\mu$ f condenser.

The set is easy to build and make work. Be sure the coil-condenser combination, (L and C1) "hit the band." Check with a wave-meter if necessary.

Quality of reproduction will not stand comparison with that of receivers which use a discriminator and which do not superregenerate. It does serve as an excellent stopgap receiver for use in areas with an FM broadcaster and few or no FM receivers, as it is much easier and cheaper to construct than a tuner with a standard FM circuit.

# METROPOLITAN

is the largest specialized testing instrument house in the country. We carry approximately 5,000 testing instruments, in stock, of all nationally advertised brands. The items listed below are only a few selected models offered at specially attractive prices in order to meet the present day demand for good merchandise, at fair prices. All units factory guaranteed for one year and available for immediate delivery from stock.

The New  
Model B-45  
**BATTERY  
OPERATED  
SIGNAL  
GENERATOR**



for servicing AM, FM and Television Receivers. R.F. frequencies from 150 Kilocycles to 50 Megacycles (150 Kc. to 12.5 Mc. on Fundamentals and from 11 Mc. to 50 Mc. on Harmonics). Complete with shielded test lead, self-contained batteries and instructions. **\$27.75** NET

**The Model 689-IF  
WESTON OHMMETER**

A convenient, pocket size ohmmeter for checking circuits by the resistance and continuity method. The energy for the resistance reading is supplied by a self-contained 1.5 volt No. 2 standard large flashlight cell. Built to meet U.S. Army Requirements for Accuracy and Durability! This Ohmmeter also has a double range 0-10 and 0-1000 ohms for the accurate measurement of low resistance values.



Model 689-IF comes complete with operating instructions, test leads and LEATHER CARRYING CASE. List price \$25.50 **\$14.85** Our Price . . . . .



**The New Model 111  
AC-DC QUALITY MULTITESTER**

A new pocket-size volt-ohm-milliammeter with features never before available in an instrument of this size and price.



D.C. Voltmeter: 0-5-50-250-500-2500 volts. A.C. Voltmeter: 0-10-100-500-1000 volts. Output Voltmeter: 0-10-100-500-1000 volts. D.C. Milliamperes: 0-1-10-100 milliamperes. D.C. Amperes: 0-1-10 amperes. Ohmmeter: 0-500-100,000 ohms; 0-1 megohm. Decibel Meter: -3 to +55 db. The scale is calibrated for line of 500 ohms impedance. For other impedances correction charts are supplied. Model 111P, in portable case (not illustrated) including testing leads and complete instructions . . . . . **\$19.85** Model 111A, open face, as shown, complete with instructions . . . . . **\$16.85**

**The New Universal  
COMBINATION TEST SPEAKER**

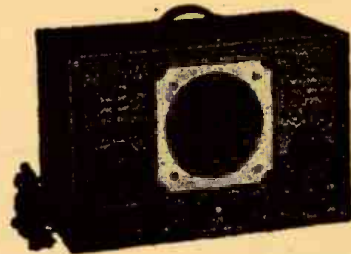

A new combination test speaker plus resistor substitutor plus condenser substitutor plus resistor tester plus condenser tester plus output meter

**A MUST FOR EVERY RADIO  
SERVICE MAN AND ENGINEER**

No need to carry the speaker to your shop in servicing any radio from the small midget to the most elaborate console. Any output tube or tubes can be matched simply by rotating input switch to listed tube and rotate field switch for proper impedance and proceed with testing. External voice coil connection permits testing of set-speaker to determine if output transformer is open or shorted. Field impedances: 500, 1000, 1500 and 2500 ohms at 175 Ma.

This unit comes housed in a rugged, battle-ship-gray, crackle-finished steel cabinet, complete with operating instructions, size 7"x11"x5", operates on 110 V. AC, 60 cyc. **\$27.50** NET

Model 570 PREMIER  
Band Spread Dial  
**SIGNAL  
GENERATOR**



AIR TRIMMERS ON ALL BANDS  
TRIPLE COPPER PLATED SHIELDING EFFECTIVE LINE FILTER  
Pure 400 cycle modulation  
(less than 5% distortion)

Range 75KC-50MC on fundamental, and 50-150MC on 3rd harmonic, useful for aligning FM and Television Receivers. Accuracy better than 1%. A.C.—115 volts, 50-60 cycles. Overall size—12"x12 1/2"x5 1/2". Complete with co-axial cables and operating instructions. **\$54.75** NET

**SPECIAL VALUE!**

National Union 5-BPI Picture and Oscilloscope Tube—Brand New, Guaranteed—Reg. list price **\$3.75** \$24.75. Our SPECIAL Price. **\$3** NET

**ORDERS FILLED SAME DAY RECEIVED!**

TERMS: 20% Deposit, Balance C.O.D. Or Full Payment with Order.

SEND FOR FREE CATALOG

Inquire about amazingly high allowance for your used Test Equipment. Write for information about New Metro Time Payment Plan. We repair all types of Testing Equipment.

**Metropolitan ELECTRONIC & INSTRUMENT CO.**

DEPT. RC-12, 42 WARREN STREET NEW YORK 7, N. Y., U. S. A.

# The Answer To Your Gift Problem

## GIVE ALL 10 BOOKS



## RADIO-CRAFT LIBRARY SERIES

**Complete Set of 10 Books \$5.00**

**Individual volumes 50c each**

Instead of the usual neckties and socks, give him something *really* different this Christmas—not only useful but something that he had his heart set on buying “some day.”

What better fits this description than the complete RADIO-CRAFT LIBRARY SERIES containing 10 practical technical books, each dealing with different phases of radio construction, testing and servicing. The books are profusely illustrated, printed in readable type and bound in handsome modern covers.

The man who receives this gift of the RADIO-CRAFT LIBRARY from you will thank you this Christmas and countless Christmases to come for giving him the means to a sound radio education and increased earning power.

SEE YOUR RADIO PARTS DEALER; IF HE CAN'T SUPPLY YOU

### MAIL THIS COUPON

RAD-CRAFT PUBLICATIONS, Dept. 127  
26 West Broadway, New York 7, N. Y.

Send me the volumes (50c each, postpaid) checked. My radio dealer is unable to supply.

I enclose \$.....

ALL 10 BOOKS \$5.00

- NO. 29—HANDY KINKS AND SHORT CUTS
- NO. 30—UNUSUAL PATENTED CIRCUITS
- NO. 31—RADIO QUESTIONS AND ANSWERS
- NO. 32—ADVANCED SERVICE TECHNIQUE

- NO. 33—AMPLIFIER BUILDER'S GUIDE
- NO. 34—RADIO-ELECTRONIC CIRCUITS
- NO. 35—AMATEUR RADIO BUILDER'S GUIDE
- NO. 36—RADIO TEST INSTRUMENTS

- NO. 37—ELEMENTARY RADIO SERVICING
- NO. 38—HOW TO BUILD RADIO RECEIVERS

Your Name..... Address.....  
(Print Clearly)

Dealer's Name..... Address.....

### SELLING A RADIO

(Continued from page 73)

interested in hearing broadcasts from their native country, and to them the short-wave band is often a most important one.

Tone controls help to get better quality or at least make the radio sound more pleasant. The presence or lack of one always should be pointed out to a customer.

In cities where electrical interference makes AM reception very noisy, FM is a boon and a blessing. A good FM set will of course cost more than a good AM receiver, but is well worth the difference in price because of the better quality achieved not only by FM's greater tone range but by the reduction of noise and static which often spoils AM programs.

Television may be a luxury for some time in the future for all but those of higher-than-average incomes. But don't shy away from the possibility of a sale for that reason! More than one television set has been sold to a buyer whose income would not seem to warrant it. Some people are very much interested in the new form of entertainment and are willing to scrape and save to have a receiver. Others with large families feel that the set is well worth its cost because it provides home entertainment for the children, and part of the cost is returned in reduced expenses for movies and other forms of outside amusements.

### THE "Book" RADIO

The Lightweight Portable That Plays Anywhere!

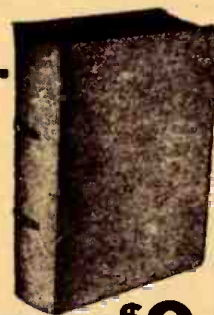

COMPLETE KIT

**\$9.95**  
less batteries

#### FEATURES

- 4" FM Alnico Speaker.
- Fingertip control of station and volume.
- Four miniature tubes.
- Size; 7½" x 9½" x 3".
- Weight: Only 4 lbs.
- Leatherette bound.

Here's the Ideal gift for Xmas ... the Ideal radio for everybody. Send \$3.50 with order. Balance C.O.D.

#### GENERAL RESEARCH LABORATORIES

222 St. Marks Avenue  
Brooklyn, New York  
DEALER'S INQUIRIES INVITED

**THIS NEW PORTABLE RADIO TAKES PICTURES**



volt B and two 1½-volt flashlight cells, No. 2 size.

The camera occupies the top 2½ inches of the 9½-inch case (which is 4¾ inches wide and 3¾ inches deep). It is of the common miniature box type, using No. 828 film (picture size roughly 1 x 1½ inch). A 50-mm fixed-focus meniscus lens is used, with a single stop and provision for both time and instantaneous exposures. The viewfinder is direct, mounted on top of the case, with the film-winding knob beside it.

The loop is so mounted in the lid that it does not depend on the hinges for contact. One heavy lead soldered to a contact in the middle of the door

A new development in portable radios is this combination of a radio and a small camera, making a single unit interesting to amateur photographers and radio enthusiasts alike.

Known as the *Air-King Radio-Camera* Model A410, it is a superheterodyne radio with a 1R5, 1T4, 1S5 and 3Q4 as tube complement. Batteries are a 67½-

acts to prevent it from swinging too widely open. The other, a wiping contact, "makes" when the door is closed.

Volume, quality and sensitivity appear to be average or above the average for this type of receiver, and the workmanship on the radio is excellent. Total weight of the radio-camera is less than 4 pounds, with batteries.

**NOW—GLASS THAT CONDUCTS ELECTRICITY**

Conductive glass, which can be electrically heated to keep it free of ice, is being installed in the control cabins of the giant Stratocruiser passenger planes, it was revealed last month.

This glass, called Nesa and developed by the Pittsburgh Plate Glass Company, has inside and outside layers of plate glass with a layer of a clear vinyl plas-

tic between. On the inside surface of the outer layer is a transparent but electrically conductive coating, whose composition is secret. By passing an electric current through the coating, regulated heat can be applied to the glass, keeping it ice and fog free at all times. The idea, it is suggested, may be applicable to automobile windshields.

*it's new  
it's timely  
it's FREE!*



**LAFAYETTE'S** new Radio Supplement and Gift Guide

**Here are some typical Lafayette Bargains**

**Phono and Amplifier Case**

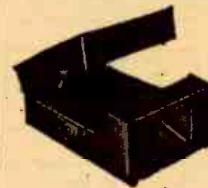

Handsome airplane luggage type case, lightweight and sturdy. Will hold phonos built to play 10 or 12-inch records, with space for 6" spkr. and amp. circuit. 13 x 14" mtg.

panel. 19 x 13¾ x 7½" overall. 8 lbs.  
X19444 Your Cost, Only .....\$6.95  
10 for .....\$55.00

**TRUTEST 67½ Volt Battery**

A powerful miniature "B" battery for portable radios, hearing aids, etc. Can be used in place of similar Burgess, Minimax, RCA, etc., batteries.



2-11/16 x 1¾ x 3-11/16"  
1½ lbs.  
XPS737 .....\$1.29

**Sensational Tube Values**



- 872A .....\$1.79
- 61 8020 ..... 3.45
- Eimac 15 E ..... 1.95
- 327 A ..... 2.95
- VT-127 A ..... 2.95
- 78P7 ..... 3.95
- 954 ..... .39

*Lafayette Radio*

RADIO WIRE TELEVISION, INC.  
100 SIXTH AVENUE, NEW YORK 13, N. Y.  
542 E. Fordham Rd. 24 Central Ave. 130 Federal St.  
Bronx 58, N. Y. Newark 2, N. J. Boston 10, Mass.

MAIL THIS COUPON TODAY

Lafayette Radio, Dept. JL-7  
100 Sixth Ave., N. Y. 13  
Rush Free Supplement & Gift Guide No. 888

Enter my order for X19444 \_\_\_\_\_  
XPS737 \_\_\_\_\_  
 Check  M.O. tube(s) \_\_\_\_\_  
Name \_\_\_\_\_  
Address \_\_\_\_\_  
City \_\_\_\_\_ Zone \_\_\_\_\_ State \_\_\_\_\_

**USE A**  
MODEL 6

**KILOVOLT FOR YOUR**

**TELEVISION POWER SUPPLY**

GIVE HIM (OR EVEN YOURSELF) ONE FOR CHRISTMAS

4000-6000 Volts D.C.  
Filtered & Shielded

\*IT'S SAFE. No 60 cycle a.c. means no dangerous high capacity condensers.

\*Does a PERFECT JOB with the 7GP4: the new, brighter 7JP4: the just out 10" electrostatic tubes.  
\*Guaranteed 3 months.

\*ECONOMICAL. Compare cost of transformer, filter condensers, rectifier and insulation.

**\$17.95**

**C. B. MFG. CO.**  
412 W. 37 St., N.Y. 18, N.Y.

**VERIFIED SPEAKERS**

*"They Glorify the Tone"*

**WRIGHT Inc.**

2234 University Avenue

St. Paul 4, Minnesota

# LEOTONE END-OF-YEAR SPECIALS

**ALNICO MAGNETS**  
Powerful ALNICO MAGNETS in many sizes and shapes always in stock. Write for latest descriptive illustrated supplement.

RO-SU CO-AX CABLE, 52 ohm, 4 ft. lengths with two PL-259 connectors (83-13P) .39  
CO-AX CABLE CONNECTORS, PL-259 (83-18P), Plated brass, Cable to 3/8" O.D. .23

**TUBES:** Perfect condition, but not in sealed cartons. Most types in stock at up to 80% off list. Every tube guaranteed 90 days.  
#20, 27, 46 or 56 .29  
or 76, 78, 77, 78, 80, 89, 513, 6H6 .39  
#35, 36, 37, 39, 54, 574, 6C5, 6V6, 6J7 .49  
6N7, 6U7, 6SA7, 6SK7, 12SA7 or 12SK7 .49  
#1A7, 1B5, 1N5, 1N6, 6A3, 6U5, 6X5, 7A7, 7C5, 7C8, 7Y4 or 50 .59  
**TUBE CARTONS:** Plain white, OT size (1 1/4" sq. x 3 1/4"), Per 100 .125  
Medium size (1 1/4" sq. x 4 3/4") Per 100 .149  
Large size (2" sq. x 5") Per 100 .179

**PHONO MOTORS** - Twin-coil 110V. AC rim-drive with 9" turntable .295  
#7 MCUIRE CHANGER ARM (Astatic), Brown enamel finish, Less L-71 cartridge .69

**T-444 DYNAMIC MICROPHONE (A.A.P.)** quality bi-polar unit with 5 1/2" ft. cord, PL-179 plug & JK-26 ext. jack .69  
**FORMEX WIRE (S.O.C.) #17 & #18 A.W.G.** Per lb. 5 to 25 lbs. Per lb. .80

**HANDY RADIO PARTS KITS**  
#1-R.F. ANTENNA & OSC. COILS, 10 ass'd. .99  
#2-MOULD'D BAKELITE COMPONENTS, 30 ass'd. 00001 to .2mfd, 200-800WV, Clearly marked .293  
#3-TUBULAR BY-PASS CAPS, 25 ass'd. .293  
#4-TUBULAR BY-PASS CAPS, 25 ass'd. .293  
#5-WAFER SOCKETS, 22 to 10 protog. .23  
#14-VARIABLE & TONE CONTROLS, 10 ass'd. wire-wound & carbon, Less switches .149  
#15-WIRE WOUND RESISTORS, 15 ass'd. ohmages, 5 to 20 watt .99  
#19-HIGH RESISTANCE UNITS, 25 carbon & wire, Ferrule-end 25K to 5 meg .49  
#20-SPEAKER REPAIR KIT, Save with this professional kit. Contains: 25 ass'd. paper rings, 10 spacers, 25 voice coil forms, 3 yds. felt strips, 20 chamois leather segments, kit of 15 splices & tube of speaker cement .249  
#27-PRECISION RESISTORS (Weston, Shafcross, etc.) 10% wire-wound, 10 ass'd. ohmages to 400K .199  
#28-ROTARY SELECTOR SWITCHES, Six model, standard makes, Incl. multi-deck & ceramic insul. .179

**MINIATURE ALNICO V PHONE UNITS** (replacement for 8-30 headsets). Approx. 75 ohms imped. Wide freq. response & sufficient volume for use as: FM or PULLOW SPEAKER, DYNAMIC or CONTACT MIKE (using "Dancer" input below) or as HEARING AID UNIT. 3/4" O.D., 1/2" deep .39

**UTC "DANCER" INPUT TRANSFORMERS** (1/2" x 1-1/2"). Dynamic mike or low impedance pick-up to grid. 49 oh. .12 for 5.00

**GLIDE PATH RECEIVER R-80/ARN-5A.** Used in instrument landing. 892-325MC. Perfect condition, less tubes & crystals. With complete schematic .495  
R-63 SCHEMATIC ONLY .EA. .10

**PHONO SCRATCH FILTER TRANSFORMER** (1 1/4" sq. x 3/4"). Complete with hook-up diagram. PE-187 POWER SUPPLY. Incomplete unit, but a "gold mine" of relays, switches, jacks, selenium rect. chokes, etc. Portable housed in metal case (6" x 3 1/2"). OD crackle finish. PLUS descriptive 173p. tech. manual. Shpg. wt. 20 lbs. .249

**PROMPT EXPERT SERVICE ON ALL SPEAKER & PHONO PICK-UP REPAIRS**  
MINIMUM ORDER \$2.00 - 20% DEPOSIT REQUIRED ON ALL ORDERS  
PLEASE ADD SUFFICIENT POSTAGE  
WRITE DEPT. RC-12

**LEOTONE RADIO CO.**  
MAKERS OF CONES AND FIELD COILS  
65-67 DEY STREET, NEW YORK 7, N.Y.  
WORTH 2-0284-5  
12,000 SQ. FT. OF RADIO PARTS

## SHOULD SERVICEMEN BE LICENSED?

(Continued from page 17)

time country-wide licensing by authorities is not necessary if the radio servicing industry can regulate itself.

♦ **RADIO-CRAFT believes that the issue is urgent.** It believes also that unless corrective steps are taken in the near future, licensing will very certainly result.

♦ **RADIO-CRAFT would welcome suggestions from within the radio servicing industry and particularly welcomes codes set up by local associations which will be publicized as models in future issues of this magazine.**

♦ **RADIO-CRAFT will welcome all suggestions on this important subject and will devote ample space to it in future issues.**

Silent Sound with power enough to pop corn, light a pipe or kill a mouse was reported from the Pennsylvania State College last month. The sound is produced by an ultrasonic siren which operates on the same principle as those on fire or police cars.

White mice placed in the sound field died after one minute of exposure. Another mouse, exposed a half minute, appeared normal eight minutes later. The following day, however, its outer ear had deteriorated. The silent siren also was found effective in killing insects. Mosquitoes died in 10 seconds but a monarch butterfly caterpillar lived 215 seconds.

## LOWEST PRICES ANYWHERE TUBES

Standard brands, in sealed cartons, 60% to 80% off, all types. No discount less than 60%.  
5 tube kit: 60L6, 35Z5, 12SA7, 12SK7, 12SQ7: . . . . . \$2.75  
5 tube kit: 50B5, 85W64, 12AT6, 12BA6, 12BE6 . . . . . \$2.75  
70L7: 79c-60L6: 59c-35Z5: 49c-12SA7: 69c-12SK7: 59c-12SQ7: 59c-35L6: 59c-35W4: 49c-12BE6: 69c-9001: 69c-9002: 69c-6J6: 69c.  
Transmitting Tubes: RK34: 98c-717A: 69c. Raytheon Acorn Tubes: Nos. 954, 955, 956, 957: 49c each. Raytheon Hearing Aid Tubes: Nos. 501ax to 509ax: 49c each.

**CONDENSERS**  
All popular brands, fresh stock, guaranteed 1 full year 20 @ 150; 25c-20/20 @ 150; 35c-8 @ 450; 30c-3/8 @ 450; 40c-16 @ 450; 49c-50/30 @ 150; 49c-30 @ 150; 29c-20 @ 100; 15c.  
**VOLUME CONTROLS, 8" Shaft:** 1/4, 1/2, 1 & 2 meg, with switch: . . . . . \$ .47  
P.M. Speakers: 5" Alnico #5 P.M., 1 oz. magnet: . . . . . \$1.39  
with output transformer: . . . . . \$1.79  
6" G-E Alnico #5 P.M., 2.47 oz. magnet: \$2.49  
12" G-E Alnico #5 P.M., 16 oz. magnet: \$7.95  
KIT OF 100 IRC assorted carbon resistors, most popular types, at 1/2 & 1 watt: \$1.79  
SET OF 2 I.F. transformers (466 KC) & matching oscillator coil: . . . . . \$1.19  
Money back guarantee.  
20% deposit with order; balance C.O.D.

**COMMERCIAL RADIO**  
36 BRATTLE ST., BOSTON 8, MASS.

## 2 NEW HIGHS IN VALUE

**Portable Kit Model B-4**

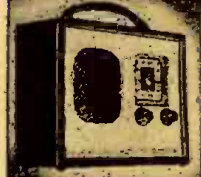

Introducing our new Kit Model B-4, a 4 tube portable receiver which operates on self-contained batteries. Approximate size: 8 x 6 1/4 x 4. Uses the following tubes: 1R5, 1U4, 1S5 and 354. Power switch is conveniently located on front of set. Alnico V permanent magnet dynamic speaker. Case covered with weather tested aircraft material. Price of kit complete with tubes . . . . . **\$9.95**

**Kit Model FM-7**



A splendid, low-priced, self-contained table model frequency modulated radio receiver kit, including speaker and beautiful Bakelite cabinet. It has a frequency response of 85-110 MC, can also be used as a TUNER with a high quality amplifier. Phono-jack is provided in rear of chassis with double pole, double throw switch control for feeding signal to either the radio speaker or to the phonojack. Additional jack for connecting extra loud speaker is included. The R.F. section of the kit is pre-tuned at the factory. Uses 2 I.F. stages, 1 limiter stage and 1 discriminator. Miniature tubes used throughout. Price of kit complete with **\$29.95** tubes

All kits accompanied by a detailed, illustrated instruction sheet. Now ready! New educational pamphlet . . . complete & simplified diagrams & instructions on all our models . . . . . 50c  
Many other kit models available. Write for catalog M.

**RADIO KITS COMPANY**  
120 Cedar Street New York 6, N. Y.

More than **2000** up-to-the-minute **RADIO and ELECTRONIC PARTS** in this just-off-the-press **ICA CATALOG**  
Standard Items  
NEW ITEMS  
New Prices

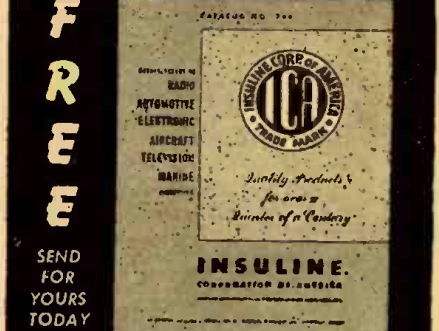

**FREE**  
SEND FOR YOURS TODAY  
NOTE: The new sensational ICA self-service MERCHANDISER IS READY!  
Write and learn how to get one FREE  
**insuline**  
CORPORATION OF AMERICA  
Insuline Building - Long Island City - New York  
More than a quarter century of quality production



# The New Model 247

# TUBE TESTER

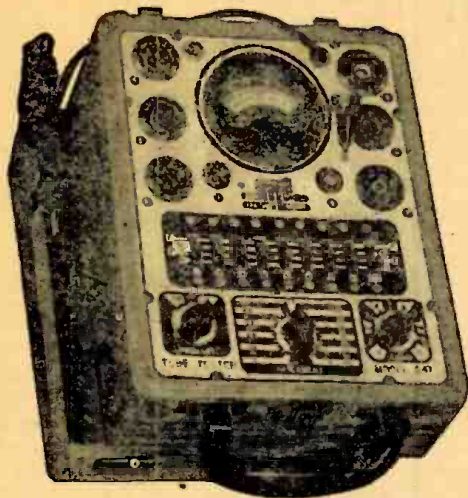

Model 247 comes complete with new speed-read chart. Comes housed in handsome, hand-rubbed oak cabinet sloped for bench use. A slip-on portable hinged cover is included for outside use.  
Size: 11¼" x 8¼" x 5¼".

20% deposit required on all C.O.D. orders.

**Features:** The Model 247 incorporates a newly designed element selector switch which reduces the possibility of obsolescence to an absolute minimum. Any pin may be used as a filament pin and the voltage applied between that pin and any other pin, or even the "top-cap."

The new free-point system described above permits the Model 247 to overcome the difficulties encountered with other emission type tube testers when checking, Diode, Triode and Pentode sections of multi-purpose tubes, because sections can be tested individually when using the new Model 247. The special isolating circuit allows each section to be tested as if it were in a separate envelope.

The Model 247 provides a super sensitive method of checking for shorts and leakages up to 5 Megohms between any and all of the terminals. Continuity between various sections is individually indicated. One of the most important improvements, we believe, is the fact that the 4 position fast-action snap switches are all numbered in exact accordance with the standard R.M.A. numbering system. Thus, if the element terminating in pin No. 7 of a tube is under test, button No. 7 is used for that test.

ONLY  
**\$29<sup>90</sup>**

**MOSS ELECTRONIC DISTRIBUTING CO.**

229 FULTON STREET  
Dept. RC-12, NEW YORK 7, N. Y.

## RADIO AND RAILROADS

(Continued from page 18)

or with ships equipped with ship-to-shore phone.

The train phone service will be available at all times when the train is within 25 miles of the 30 or more cities which have mobile telephone systems. As the use of mobile telephone increases, it will be possible to call from almost any point along any railroad line. Calls can be received while the train is within the



Radio Central of "The Train of Tomorrow." Radiophone handset is at (1) a control box at (2) wire recorder at (3) broadcast receiver at (4) and PA amplifier at (5). Mobile radio transmitter and receiver are in cabinet below.

same range of mobile service control stations. (Mobile service has already begun on standard railroad runs, as described in RADIO-CRAFT in October.)

A person who wishes to talk to a passenger first calls long distance, then asks for the mobile operator. Given the approximate location of the train, the operator routes the call over regular land lines to the nearest mobile radio operator, and the last link is by radio-phone.

Communication with the train is effected with FM. An antenna is mounted on the roof of the lounge car for transmission and reception. The train transmitter operates on 157.89 mc, the receiver on 152.63 mc.

Your work looks better  
with



**AMCON PLASTIC**

**3 Star Performers!**

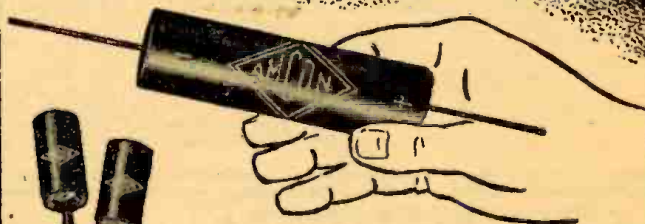

Point out the Amcon Plastic-encased Capacitors the next time you return a chassis you have serviced. Your customer can see the quality of your work as well as appreciate the improved performance it has accomplished. Amcon Plastics are top-quality components that look the part—they have sales appeal as well as "engineer" appeal!

ASK YOUR JOBBER FOR THE "3 STAR PERFORMERS" CATALOG



**AMERICAN CONDENSER CO.**

4410 N. Ravenswood Ave., Chicago 40, Illinois

# Watch for The Big **RADIO CRAFT** Television Number Next Month

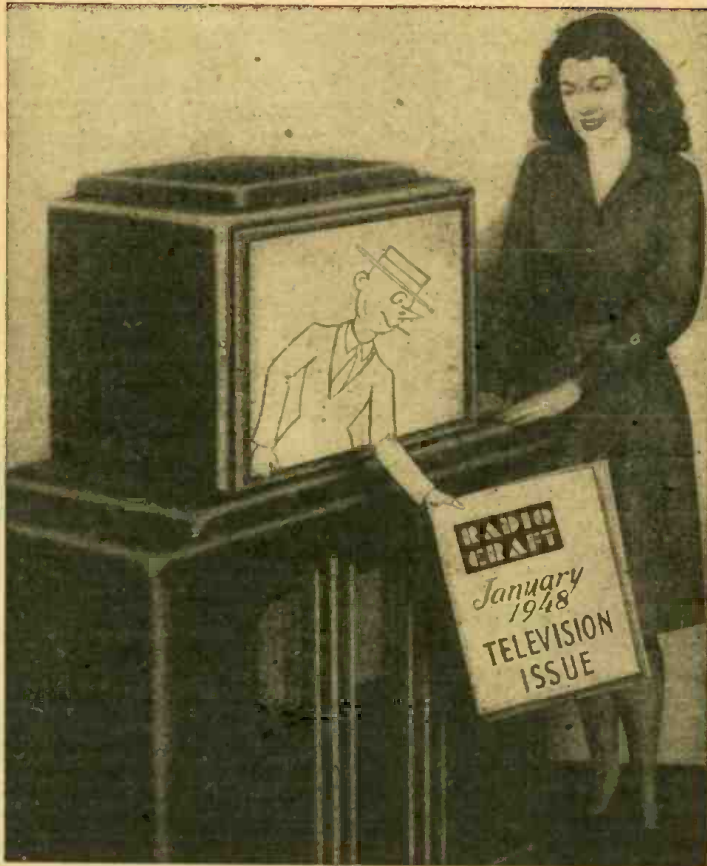

The beginning of 1948 will be an important milestone in the technical advance of television. It is in keeping with the upsurge in popularity which television receivers are now experiencing. The first six months of 1947 have shown over 900% greater television set production than the last six months of 1946. A half million sets are expected to be produced by June, 1948. About 20 broadcast stations will be in operation. This will be increased to 30-40 by the end of the year. Such production figures have an indirect bearing on technical developments. The public purchases sets when performance as well as price satisfy. It is the purpose of RADIO-CRAFT'S Special Television Number to report recent technical improvements to help our readers, in servicing television sets—to advance the art of television, in general, and to benefit the public.

The January Television Issue will not be a historical review number—nor will it carry opinions of personalities in the industry. The Special Issue will be confined strictly to practical, technical news—news that will be really fresh and worthwhile in January, 1948. Be sure to watch for the big January Television Issue. If you are not already a subscriber, it will be an excellent issue to start a RADIO-CRAFT subscription.

## FOR CASH OR CREDIT NEWARK VALUES LEAD THE FIELD!

Authorized Distributors of  
ALL STANDARD MAKES OF RADIO  
AND ELECTRONIC EQUIPMENT  
TELEVISION SETS, KITS & PARTS  
PUBLIC ADDRESS & SOUND EQUIP'T.

TAKE ONE YEAR TO PAY  
for Equipment Totalling \$75 or Over  
20% Down—12 Monthly Payments\*  
\*Plus 6% Carrying Charge—Send for Order Blank

NEW YORK  
Offices & Warehouse  
242 W. 55th St., N.Y. 19

**NEWARK**  
ELECTRIC COMPANY, INC.

CHICAGO  
323 W. Madison St.  
Chicago 6, Ill.

New York City Stores: 115-17 W. 45th St. & 212 Fulton St.

### \$3.00 FOR CARTOON IDEAS

RADIO-CRAFT prints several radio cartoons every month. Readers are invited to contribute humorous radio ideas which can be used in cartoon form. It is not necessary that you draw a sketch, unless you wish.

#### IDEAS NOT WANTED

No electrical or radio definitions wanted. Some of these were published in the past, but the subject is about exhausted.

All checks are payable on publication.

Address RADIO CARTOONS, RADIO-CRAFT, 25 West Broadway, New York 7, N. Y.

Radar equipment designed by Raytheon for use on the Great Lakes has 6 ranges: 1, 2, 4, 8, 20 and 40 statute miles. The short ranges are expected to be particularly useful at the close ranges encountered in lake navigation.

## HIGH-RANGE OHMMETER

(Continued from page 34)

If the scale could be expanded at the ends and compressed in the middle either arithmetically or logarithmically, the difficulty could be overcome. A satisfactory and simple method of expanding the scale distances at the ends and compressing them in the center was found. Through this scale the value of the ohmmeter was immensely enhanced.

The scale is best drawn on a piece of good strong drawing paper. The longer the scale the better, as readings will be clearer. The maximum length is limited by the available space on the panel. A length of 8 inches is excellent.

Four horizontal lines, about 1/4-inch apart and 8 inches long, should be drawn. The exact center is determined. Then the beginning is marked 0, the middle 0.5, and the end 1. ma. Vertical lines are drawn from the top to the bottom lines. The spacing for the other values of milliamperes is arrived by marking off 5 to 6 and 5 to 4 each 1/2 inch apart. From 6 to 7 and 4 to 3 the distance is 1/2 inch. From 7 to 8 and 3 to 2 it is 1/4 inch. From 8 to 9 and 2 to 1 there is 1 inch distance, and the last gap at both ends is 1 1/4 inches.

This produces a scale with ends 3 times as open as the middle. Ample space is provided for writing in ohmic values. The scale is therefore compressed in the center and expanded at both ends.

TABLE I

READING, MA	MEGOHMS
0.1	2.7
0.2	1.2
0.3	0.7
0.4	0.45
0.5	0.3
0.6	0.2
0.7	0.13
0.8	0.075
0.9	0.033
1.0	0

Full-scale reading (1 ma) corresponds to zero resistance with 300,000 ohms in the internal circuit. Half scale (0.5) will correspond to 300,000 ohms limiting, plus 300,000 ohms test resistance, so the 300,000-ohm mark falls at the center of the scale. Values for other markings will be as per Table 1, provided always that the instrument is working on exactly 300 volts.

A better method of marking appears in Fig. 2. The readings of this latter table have been rounded off, but are near enough for all practical purposes. A glance shows that useful readings are obtained from 10,000 ohms to 14 megohms. For voltages other than 300, a corresponding set of scales would have to be worked out, either by measuring actual resistances or by computation based on Ohm's law.

The help offered by this scale may not seem important at first glance, but use will convince you of its value.

## FM TUNERS

(Continued from page 25)

and are wound with No. 12 enameled wire. Turns are spaced  $\frac{1}{4}$  inch. RFC-1 and RFC-2 are 5 millihenries each. RFC-3 is 15 turns of No. 16 wire, close-wound on a  $\frac{1}{4}$ -inch dowel.

The physical layout for the 10.7-kc i.f. amplifier should be made with caution. Each wire from the i.f. transformer can should be brought out through a hole drilled as close to the correct socket pin as possible. It is preferable to mount the stages in a straight line to avoid extra shielding. The interstage shield needed in this tuner can be seen in the under-chassis photograph. Also, small circular shields were soldered in the center of the circle of pins on 2 of the tube sockets. If the i.f. transformers are not provided with swamping resistors, each winding should have a 37,000-ohm resistor (or such resistor value as the manufacturer recommends) paralleled across it.

The tuner of Fig. 2 is like that of Fig. 1 in most details. A 6BE6 is used as the oscillator. The oscillator coil is tapped 1 turn from the bottom. Limiter voltages and constants differ from those used when there are 2 limiters. If desired, a 6AL5 discriminator can be used instead of the crystals. This will probably result in a saving in expense, but will increase the filament drain slightly.

### Some important points

Many considerations are overlooked by the constructor who is assembling his first FM receiver or tuner. In wiring the r.f. mixer, and oscillator sections it is important not only to secure the shortest grid lead but also to provide thorough grounding and bypassing. Especially important are low inductive paths to the tuning-condenser frame and wiper contacts. Each stage should have its own heavy braid ground wire from the coil (if the coil is not mounted on the condenser) and tie point for the bypass condensers running as directly to the tuning condenser as possible. If tuning is noisy, it is usually the result of poor rotor contacts. This common trouble is easily cured by a cleaning and lubricating job. If the circuit is wired properly and decoupled, there should be no oscillation trouble in the i.f. stages. Filament bypassing is very important in high-gain circuits. Don't forget it!

Oscillation is not usually evidenced as a whistle or squeal in an FM receiver. Heavy oscillation is evidenced by complete closing of the tuning eye even without any signal. Light oscillation results in distortion on strong FM signals.

As stated before, all the bugs have been worked out of this circuit and there should be little trouble. For alignment of the circuit it is best to beg, borrow, or steal a high-frequency generator. It can be done by hand, but it is tedious business. Much better alignment information is given in the handbooks and circuit manuals than could be given in this brief article, and their use is recommended.

## NUMBERS 4 and 5 OF THE WALSCO Hit Parade

THE SENSATIONAL, NEW, SCIENTIFIC

### WALSCO STANDARD TEST RECORD

FOR IMMEDIATE... ACCURATE... AUDIBLE ADJUSTMENT OF RECORD CHANGERS AND COIN OPERATED PHONOGRAPHS... SOLVES THE PROBLEM OF ADJUSTING PICKUP AND TRIPPING MECHANISM THROUGH

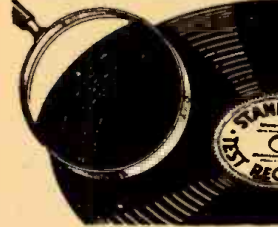

- Three Tone lead-in grooves permits immediate adjustment to proper set down position of the pick-up through audible means.
- Made to RMA and NAB standards.
- Record plays in less than 40 seconds.
- Audio tone at end of record indicates proper adjustment of tripping action.

The WALSCO Standard Test Record saves time and increases efficiency in the adjustment of record changers and coin operated phonographs. Write for full information.

## WALSCO UNIBELT THE UNIVERSAL DIAL DRIVE BELT CAN BE CUT TO FIT ANY DIAL DRIVE Will not Slip or Stretch

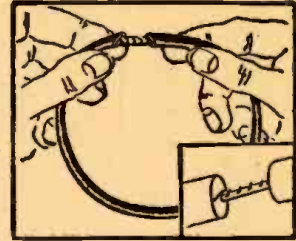

"UNIBELT" comes in 5-foot length spools and can be installed without taking dial mechanism apart. A real time and money saver. Eliminates the need for stocking numerous sizes of belts.

Free sample and literature. Write to Dept. 12B

## WALSCO products

WALTER L. SCHOTT CO. BEVERLY HILLS CALIF. CHICAGO 5, ILL.

## RED HOT SPECIALS

Limited quantity for immediate shipment— while they last

### 8,000 OHM DUAL HEADSET H-16/U

Priced at **\$1.89**

Include 25c to Cover Cost of Postage



### Combination Offer

Both Items **\$2.25**  
Include 25c to Cover Cost of Postage

20% deposit on all orders unless rated.

Light, durable, and efficient phones featuring a permanent magnet with an 8000 ohm transformer built into each unit. Molded soft neoprene earcup strapped to snugly and comfortably envelop the entire ear. Steel headband with new type adjustable sliding brackets allow earcups to be extended or retracted. Cover plates constructed of lightweight magnesium. No removable parts to become loose or lost. Especially suited to hams and commercial operators, recording engineers, aircraft pilots and similar exacting applications. Hi-impedance, extremely sensitive. May be used as sound powered interphones without use of a battery. Can even be used with simple tctal to make a complete radio receiver.

### Carbon Throat Microphone

This microphone will work into any 200 ohm impedance input circuit. Has adjustable strap to fit any neck. In operation this microphone is strapped around the throat thereby facilitating full freedom of both hands and head movement. Ideal for ultra high frequency mobile work for hams. Can also be used as a hi-grade Carbon Mike by simply drilling three holes. In case. Sensitivity of this mike equal to mikes costing \$10 and \$15. Supplied with strap, 10' cord and plug. Your Cost .....



**49c**

## NIAGARA RADIO SUPPLY CORP.

160 GREENWICH ST., NEW YORK 6, N. Y.

All prices F.O.B. N. Y. C. Write for latest Bulletin 10RC

## THE PRICES SPEAK for THEMSELVES

### RADIO TUBES-KNOWN BRANDS-BULK

	EACH
80, 5U4G, 5Y3GT, 5Y4GT.....	\$.42
35W4, 25Z5, 25ZSGT, 35Z5.....	.45
6F5G, 6F6GT, 6J5, 6BA7, 6SK7, 6SQ7....	.47
12BE6, 12BA6, 12AT6, 12SK7, 12SA7, 12SQ7	.49
6H6 6J7, 6K7, 6Q7, 6SF5GT, 6SN7GT....	.55
5Z3, 35A5, 35L6, 50B5, 50L6.....	.55
43, 6A7, 6A8, 6V6GT, 25L6GT.....	.59
OZ4, 6X5GT, 7A8, 7B4, 7B5, 7B7.....	.65
1A5GT, 1A7GT, 1H5GT, 1N5C7, 1R5, 1R4, 1S5	.74
1T4, 3Q4, 3Q5GT, 50A5, 14A7, 14B6, 14Q7	.79
6AC7, 6L6G, 25A6G, 35Y4, 117Z6GT.....	.95
1LA6, 1LE8, 1LN5, 70L7, 117L7GT, 117N7GT	1.35

### ELECTROLYTIC CONDENSERS

	EACH
10-150 V	.22
20/20-150 V	.26
30-150 V	.28
40/40/20-150 V, 25 V	.44
8-450 V	.27
10-450 V	.32
16-450 V	.36
16/16-450 V	.59
20-450 V	.39
30-450 V	.47
40-450 V	.54

WIRE — WRITE — PHONE

## BROOKS RADIO DISTRIBUTING CORP.

80 VESEY STREET (DEPT. A), NEW YORK 7, N. Y. (CORlandt 7-2312)

## BONAFIDE VALUES

**SHURE T17B**  
Push Button Carbon Mike  
**98c**  
With Cord and Plug Value \$12.00

**SHURE CRYSTAL MIKE**  
**\$6.95**  
With Stand, Base and 7 Ft. Cable Value \$18.50

**HAZELTON INSTRUMENT CO. MODEL 100**  
Pocket Multimeter 2" Movement, 1000 ohms PV, A.C. Volts 0-15, 150, 1500; D.C. Volts 0-15, 150, 300, 1500; Ohms 0-3000, 300,000; Mills 0-1.5, 15, 150 ..... **\$9.95**

**DETROLA AUTO-MATIC RECORD CHANGER**  
Plays 10- and 12-inch records. Enjoy almost 30 minutes of uninterrupted music. Special Low Price ..... **\$14.49**

Webster #50 .....	\$21.09
Webster #56 with automatic stop .....	25.95
Seeburg 2 post changer .....	21.97
Maguire, 2 post automatic stop .....	11.95

**2 TUBE PHONO OSCILLATOR**  
Complete with tubes, 35Z5, 12SA7. Use with record player, and tune in on any radio.  
Complete, **\$4.75**  
All Wired

3 Tube PHONO AMPLIFIER Volume and tone control, ALL WIRED with Tubes .....	\$4.95
ASTATIC Pick Up Model L-70 .....	2.25
A.C. Phono Motor .....	2.25

### SPEAKER BUYS

4" Heavy Alnico Slug PM .....	\$1.35
5" Heavy Alnico Slug PM .....	1.39
6" Heavy Alnico Slug PM .....	4.95
10" Heavy Alnico Slug PM .....	5.95
12" Heavy Alnico Slug PM .....	7.95

### 5 TUBE AC-DC KIT

Superhet radio kit—complete with plastic cabinet, tubes, instructions ..... **\$14.95**

### STANDARD TUBE KIT

Consists of 35Z5, 50L6, 12SA7, 12SK7, 128Q7 **\$3.50**

### CONDENSERS C.D., SOLAR, ETC.

40 MFD—150 v. ....	\$.38
40 MFD—450 v. ....	.79
50 Assorted Mica Condensers.....	2.29

### MISCELLANEOUS

HS-30U Hearing Aid type Earphones .....	\$.98
Signal M-100 Brass Key .....	.79
92 Ohm Twin Coaxial Cable .....	per ft. .09
505U Coaxial Cable .....	per ft. .06
1/2 meg. Vol. controls & switch .....	Lot of 6 .49
100 Assort. IRC Resistors .....	1.79
Trim—P-16 Headphones .....	1.95
8 Section Telescopic Aerial with clamping brackets with heavy lead .....	1.95
Model 680—5000 ohm per volt—volt-ohm milliammeter, Regular \$28.50 .....	19.75
B-45 All wave Signal Generator .....	27.75
Dial Light with "dimout" .....	.29 ea. 4 for 1.00

25% Deposit, Bal. C.O.D. Plus Charges  
Write for Latest Catalog

## BONAFIDE RADIO CO.

89 1/2 Cortlandt St., Dept. F, N. Y. 7, N. Y.

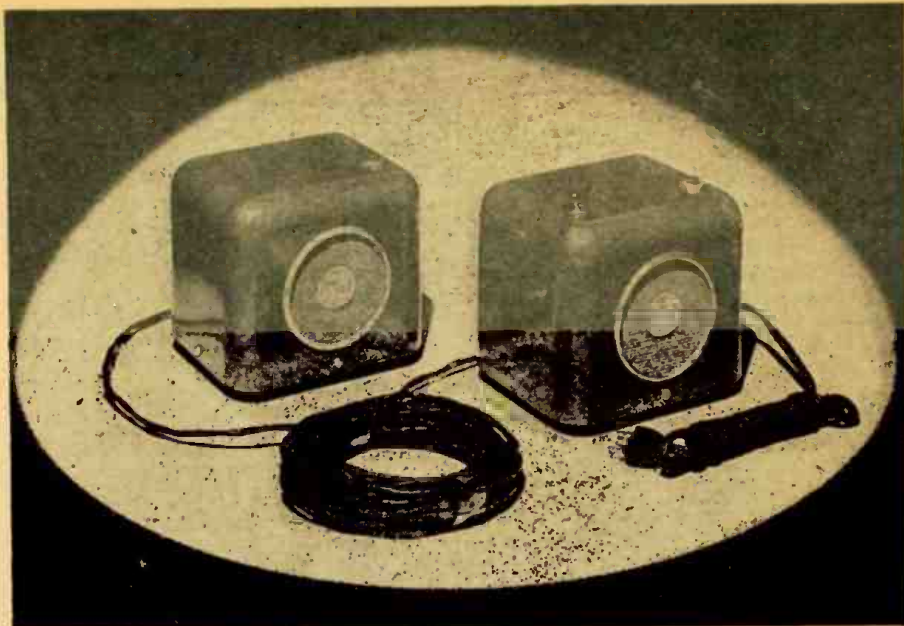

Courtesy Electronic Laboratories

## Interesting Intercommunicator

THE widespread use of intercommunications systems in the Armed Forces and industry during the war has resulted in ever-increasing demands for these versatile units on farms, in homes, stores, offices, and business organizations. Remote stations at the front entrance to the home, in basements, attics, garages, barns, nurseries, and numerous other places are becoming very common as well.

An interesting postwar intercom recently tested by RADIO-CRAFT is the Utiliphone manufactured by Electronic Laboratories, Indianapolis. It is a wired intercommunications system consisting of a master and 1 remote station operating up to 500 feet apart. Each unit is housed in a gray, wrinkle-finished metal box with a chromium-trimmed speaker grill. Each station is only 5 1/4 inches wide, 4 1/2 inches deep, and 5 inches high. It can be mounted on a desk or hung at a convenient place on a wall by 2 key-slots on the rear panel. Three-wire cable is used between stations with connections made to a 2-screw terminal strip

and common ground screw on each unit.

A 3-tube amplifier is included in the master unit. The amplifiers are available in 3 models. Loctal tubes are used in Model 2660, miniatures in the 2660A, and octals in 2660B. The circuit, Fig. 1, is the same in all models. V1 is the speech amplifier, which is resistance-coupled to the power amplifier V2. Operation is from 117-volt, a.c.-d.c. lines with the half-wave rectifier V3. The series-connected filaments are supplied through a dropping resistor. The tube line-up of the 3 models is:

Function,	MODEL		
	2660	2660A	2660B
Speech Amplifier T1	14A7	12BA6	12SK7
Power amplifier T2	50A5	50B5	50L6
Rectifier T3	35Y4	35W4	35Z5

A remote station can be installed in a child's playroom or nursery. When its switch is locked in position, the parents are able to listen to the child while in remote parts of the house.

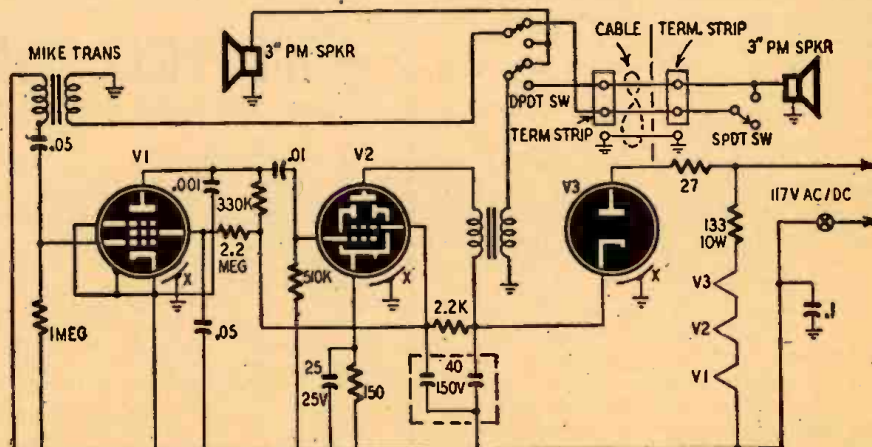

X—EXTERNAL SHIELD ON LOCTAL TUBES ONLY

Fig. 1—This 3-tube circuit combines high sensitivity, good speech quality and high output.

KNOWLEDGE  
THAT HAS  
ENDURED WITH  
THE PYRAMIDS

## A SECRET METHOD FOR THE MASTERY OF LIFE

WHENCE came the knowledge that built the Pyramids? Where did the first builders in the Nile Valley acquire their astounding wisdom that started man on his upward climb? Did their knowledge come from a race now submerged beneath the sea? From what concealed source came the wisdom that produced such characters as Amenhotep IV, Leonardo da Vinci, Isaac Newton, and a host of others?

Today it is known that they discovered and used certain *Secret Methods* for the development of their inner power of mind. They truly learned to master life. This secret art of living has been preserved and handed down throughout the ages and today is extended to those who dare use its profound principles to meet and solve the problems of life in these complex times.

This Sealed Book — FREE

The Rosicrucians (not a religious organization) have prepared an unusual book, which will be sent free to sincere inquirers, in which the method of receiving these principles and natural laws is explained.

Write today for your copy of this sealed book. Possibly it will be the first step whereby you can accomplish many of your secret ambitions and the building of personal achievements. Address your inquiry to: Scribe K.T.X.

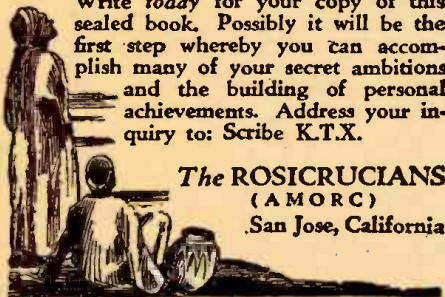

The ROSICRUCIANS  
(AMORC)  
San Jose, California

Do you need

### BINDING POSTS?



The XL PUSH POST with its Spring Action assures Constant Contact and quick connection. Manufactured in All Aluminum Type M at 12¢ each. Aluminum Body, Bakelite Top Type B1 at 15¢ each. Types CP or NP, ALL BRASS—STAINLESS STEEL SPRING & PIN. PROVEN BY 240 HR. SALT SPRAY TEST as NON-CORROSIVE at 28¢ each. Manufacturers and Dealers Liberal Discounts

X. L. RADIO LABORATORIES  
420 West Chicago Ave., Chicago 10, Ill.

### TUBE SHIELDS

While constructing a small portable receiver, I found that I could not obtain shields for the 1N5G and other tubes in this series. I salvaged the can of a discarded wet electrolytic condenser. The top was sawed off and the can sliced into lengths equal to the length of the tube. Screw lugs were fastened to the bottom edge and used for mounting on the chassis. These make good shields.

JOHN L. TARDIF,  
Toronto, Ont.

## ELEMENTARY RADIO QUIZ

By HAROLD GLENN

Check your radio knowledge. A more advanced quiz will appear in an early issue.

1. Light and electricity are energy, and travel in the form of: 1.—waves; 2.—frequency; 3.—amplitude; 4.—electrons.
2. Which has the longest wave length? 1.—light; 2.—heat; 3.—radio.
3. The inductance is: 1.—a coil; 2.—a condenser; 3.—an air core; 4.—an iron core.
4. The to-and-fro surge of an electric current in a circuit is called: 1.—detection; 2.—inductance; 3.—oscillation; 4.—capacitance.
5. The loudspeaker changes: 1.—sound into electric waves; 2.—r.f. to a.f.; 3.—a.f. to r.f.; 4.—electric waves into sound waves.
6. In order to operate, the loudspeaker must have: 1.—r.f. waves; 2.—a.f. waves; 3.—pure direct current; 4.—pure a.c. sine wave.
7. The purpose of the detector is to change: 1.—a.f. to r.f.; 2.—r.f. to a.f.; 3.—resonance to oscillation; 4.—oscillation to resonance.
8. The action of the detector is called: 1.—resonance; 2.—rectification; 3.—oscillation.
9. Resistance in the tuned circuit causes: 1.—distortion; 2.—rectification; 3.—broad tuning; 4.—oscillation.
10. What is the frequency of 60-cycle, 117-volt, 100-watt house current?

(See page 93 for answers)

## THE QUESTION BOX

(Continued from page 56)

Expansion and compression is made possible by taking the amplified signal from the grid circuit of the 6SC7 and applying it to a 6C8-G where it is amplified and rectified. The output of the rectifier section is applied to the No. 3 grid of the 6L7. Polarity of the control voltage may be changed to give either compression or expansion.

Sufficient gain has been built into the amplifier to enable it to operate efficiently from almost any microphone or phonograph pickup.

If you find that the 6L7 is microphonic in this application, use its non-microphonic version, the 1612.

## ELECTRONIC VOLT-OHMMETER

\$11.85

110 VOLTS AC 20 RANGES  
0/5/10/50/100/500/1000/5000  
volts DC and AC, 0-1,000,000,000  
ohms in six overlapping ranges. Sen-  
sitivity: over MILLION OHMS per  
VOLT on 5 volt range.

POSTPAID

Complete kit includes all component parts, tubes, punched and drilled chassis and beautifully enameled panel. Easily assembled and wired.

Special all-back circuit developed during war by scientist at the California Institute of Technology gives amazing sensitivity and flexibility while completely eliminating necessity of batteries and expensive meter. Each instrument is individually calibrated. Dial scale over nine inches long!

In addition to performing the usual volt-ohm functions, this instrument easily measures these voltages: SUPERBET OSCILLATOR, AVC, APC, TRUE GRID BIAS AT THE GRID, BIAS CELLS without affecting the circuit. Measures the exact leakage resistance of INSULATION, TUBES, CONDENSERS. It can be used with a signal generator for SIGNAL TRACING.

STERLING ELECTRONIC COMPANY  
BOWLING GREEN, KENTUCKY

## GOVERNMENT SURPLUS

We have on hand a large selection of Radio and Electronic Equipment purchased from the United States Government, and solicit your inquiry on practically any equipment or component parts used by the Army or Navy. Listed below are only a few of the many items we now have in stock.

Gasoline engine generating plant, PE-182, 9.4 kva @ 0.8 power factor 7.5 kw, 120/208-volt, three phase, 26-ampere unit. It consists of a Willys Model G.F. gasoline engine and miscellaneous engine auxiliaries directly connected to an alternator with built-in exciter. Export packed with spare parts and tools. Full instructions. Weight 1035 lbs. New .. \$699.00

Scope, 5" 110 V 60 Cycle input. Control unit BC-1266. 15 tubes including 6CP11. Has all power supplies built in except for 360 Volt amp. B Voltage. Our price .. 39.95

Indicator I-22A. Uses Selsyn with indicating rose, 100 TH power tube, assorted breakers, high voltage condensers, etc. Good for antenna and transmitter control and remote modulator basic kit. 110 V 60 cye .. 27.50

SAVE EIGHT DOLLARS! Purchase both of the preceding items, packed in original shipping case and crate .. 59.50

Handset TS-13, 200 ohm carbon mike and 2500 ohm ear phone with battery switch. Has 6 ft. rubber cord with 1 PL55 and PL68 plugs attached Bakelite case, light weight .. 2.95

SCR-522 Receiver Transmitter. Get this swell VHF Transceiver. One of the finest and most economical 2-meter rigs you can buy today. Now available for a small fraction of the original cost. Covers 100-156 MC. Ideal for aircraft communication airport control and taxi-cab radio. Furnished with 17 tubes .. 19.95

Lifesman's polo climbers with straps and pads 4.50  
Safety Belt with strap. State belt sizes .. 5.75

Strap, adjustable from 4' to 5' with snap on hooks. Heavy duty webbing 2" wide. For strap-on console in trucks, etc. .... 29

Asbestos Gloves. Suitable for welders, hot material handlers. Heavy duty. Sizes 10 & 11 pair .. 1.25

Clipboard, 8 1/2 x 11" full length clip and cover. New .. 89

Spark Plug Suppressors—6 for .. 35

Box of 50 .. 2.25

SHURE Featherweight, crystal pick-ups. New .. 2.89

RGS/U Coax. 52 ohm, 50' and over—per ft. ... .06

300 ohm twin lead transmission lines. 25' or more, per ft. .... 025

7 conductor cable, heavy duty, 65' #14 stranded. Rubber covered. Connector on both ends .. 3.95

14 conductor heavy duty. Rubber covered cable #15 stranded 50' roll. Receptacle on one end 3.95

Terminal lug tinned copper 5/16" hole, per 100 .. 50

Terminal lug tinned copper #6, per 100 .. 38

Pilot lamp socket bayonet base. 18" lead. 2 for Fusetron, 10 amp plug style #710 Bussman 4 for .. 19

Kit of tubes 25 all new. Satisfaction guaranteed, or money refunded .. 6.95

Resistors, 1/2 watt. Kit of 100, assorted .. 1.89

45 V BA-26 Heavy Duty "B" Batteries 8 x 4 1/2 x 7 1/2". Date of mfg. May 1945 or later. Carton of 4 .. 1.98

6 V Lantern Battery. 2 1/2 x 2 1/4 x 3 1/2". Date of mfg. June 1945 or later. Box of 30 .. 2.75

Fluorescent kitchen units. 2 tube 20 watt. Just plug in .. 7.29

Standard Typewriters. L. C. Smith, Remington, Underwood. Shipped subject to your inspection. Reconditioned. Perfect Shape .. 59.50

## SPECIAL \$25.00 OFFER

On a deposit of \$5.00 we will ship you C.O.D. Freight Collect a large quantity of Government Surplus Radio items subject to your inspection and approval. If, after inspecting you are not more than satisfied, return to us Freight Collect and all it will have cost you will be freight charges one way. You should be able to dispose of a few of the items that you may not need for the entire cost. This is the cheapest way we can sell you War Surplus Radio Material. Our warehouses are filled with thousands of choice Government Surplus Radio items. Lots of them we do not have in sufficient quantity to advertise nationally and the cost of inventorying, itemizing, corresponding, etc., would only increase their cost; therefore, we make this offer. If you wish to mention a few items you desire, we will endeavor to include them in this assortment.

Above prices F.O.B. Baltimore  
Minimum Order \$2.00

The Abell Distributing Company  
5 E. Biddle St. Baltimore 2, Md.

Send for our Flyer—  
Name Items Interested in

### TEST UNIT 1-35-E

One of the component units required to test the "Walkie Talkie" Transmitter and Receiver EC-511. Consists of a 4" rectangular multi-range meter, Switching facilities, Microphone, receiver, earphone, R.F. oscillator, audio oscillator, crystal set socket, pin jacks, test terminal cabinet, plus. Comes in cabinet with removable cover 9" wide, 14" long, x 5" high with Technical Manual and circuit diagram. Full scale ranges of 3 & 150 D.C. 1.5, 5, 30 & 600 MA D.C.; and 80 V A.C. Suitable for modification into a versatile radio test unit.  
NET fob, NY ..... \$13.50

### BC-1072-A RADAR TRANSMITTER

150 to 210 Megacycles: Operates off 115 volt, 60 cycle power line. This unit can be adapted to a 2 meter band transmitter but its chief value is for the parts it contains.  
BLOWER, 115 volt 60 cycle 28 watts .38 1625 R.P.M. A.G. Redmond.  
VARIAC, Gen. Radio type 200 B 115 volt input, 135 volt 1.5 amps. Max. output.  
TUBES, 2-5U4G's; 1-807; 1-2X2; 1-6SN7; 1-6J5; 1-9002; 2-9009; 2-826.  
METER, Simpson, 3 1/2", round, 0-5 Kilovolt and 0-10 M.A. D.C.  
TRANSFORMERS, 1—with primary variable from 0-135 volt, secondary 0-350 V; 1—with primary 117 volt secondary 6.3 V at 1A; Amps. 27.5 volt center tap to each side, 5.0 volt at 3 Amp.; 1—with 117 volt primary, secondary 4 volt at 16 amp. and 2.5 volt at 1.7 amp.  
Consists also of many other parts, relays, transformers, circuit breakers, interlocks, resistors, chokes, too numerous to mention.  
Complete in metal cabinet 18" x 20" x 17 1/2"; net wt. 150 lbs.  
NET FOB, N.Y. .... \$22.50

FILAMENT TRANSFORMER, G.E., 110 volt, 60 cycle input, 2.5 volt 4 Amp. Output, 100 KVA, 3 KV. Insulation, @ \$2.75 each, Ten for ..... \$17.50  
STEP DOWN TRANSFORMER, Jefferson Electric, 115 volt 60 cycle primary 20 volt, 10 Amp. secondary, Ten mounted in watertight box, @ \$3.95 each, Ten for ..... \$39.00  
VARIABLE RHEOSTAT, Ward Leonard 8" Class, 20 Ohms 4.0 Amp. Complete with all hardware, @ \$3.50 each, Ten for ..... \$29.50

### INVERTER PE-206-A

INPUT: 27.5 Volt 38 Amps D.C.  
OUTPUT: 80 Volts 500 V.A. 800 cycle 1.0 P.P. 1 phase 6000 R.P.M.  
Manufactured by the Leland Electric Co., Type #DA. Complete with filter, carbon pile regulator, selenium rectifier, etc. with circuit diagram and handbook of maintenance instructions. Dimensions 13" L x 10" H x 8" W ..... NET fob, \$6.90  
D.C. MOTOR—Permanent Magnet Type 10,000 R.P.M. Deico Type 2509970 27.5 Volt D.C. 2 1/2", Long (1/2 shaft) x 1" W 1 1/2" High ..... \$4.95

### POWER LEVEL INDICATOR

Weston Model 895 Type 3 A: A rectifier type voltmeter with 8 ranges of 1.5, 6, 15, 60 and 150 volts and  
A multi-range DB meter for a zero signal level of 6 milliwatt on a 500 ohm load. Adjusted to indicate -3, -4, "0", +4, +8, +12, +16, +20, +24, +28, +32 DB at "0" on the DB scale or a total spread of 58 DB.  
A plate fastened on back of instrument gives instructions and conversion data for use on other than 500 ohm circuits.  
Dimensions 5 1/2" x 3 3/4" x 3 1/8". NET \$19.50

### PANEL METERS

SIGNAL STRENGTH ("S") METER—Simpson 25, 3 1/2" rd & bake case. Use this on the plate circuit of your receiver to show the relative strength of incoming signals. Sc calibrated—6 to 100 DB above 1 microvolt, 5 MA zero right with translucent sc, for internal sc illumination from rear of meter. Comp with socket, lamp and leads. For further details refer to pages 184-185 & FIR. 730 B of Radio Amateur's Handbook ..... \$3.50  
DECIBEL METERS—Weston 301, Type 21, 3 1/2", rd & bake case, minus 10 to plus 6, 0 M.W., 600 ohms; General purpose for constant and variable reading, 45-82% overthrow, 5000 ohms internal resistance at ODB ..... \$3.50  
—W.H. RC-35, minus 10 to plus 6, ODB scale, 5000 ohms internal resistance, 3 square ..... \$4.50  
TOTALIZING HOUR METERS—G.E., 3 1/2", rd & bake case; Up to 9,999.9 hrs. Operates on 10-12 volt, 60 cycle. Ideal for counting the total hours of operation of the power tubes on transmitters, etc. .... \$3.50  
—Industrial Timing Corp., indicates up to 9,999.9 hrs. for 50 or 60 cycle operation on 105 to 130 volts. Black scale 3" rd & bakelite case. Clamp mounted ..... \$4.00  
FREQUENCY METERS—B.T. 312, rd & metal case, 58-62 cycle, 5 reed, 100-150 volts ..... \$4.50  
—J.B.T. 30-F, Dual range covers frequency ranges from 48-52 cycles to 1000 cycles. Dial element, Vibrating Reed type, 115 volt, 3 1/2", rd & metal case ..... \$5.95  
D.C. VOLTMETERS—W.S. 500 V, 1000 ohms per volt; 3 1/2", rd & bake case, concentric style \$3.99  
—Weston 301, 3 1/2", 4 K.V. with external "re" resistor ..... \$6.50  
—W.E. NX-65, 1.5 K.V. with 5000 ohms per volt, ext prec wire wound resistor & mtg clips, 3 1/2", rd & bake case ..... \$7.25  
—W.H. NX-35, 20 KV ext prec wire wound 1000 ohms per volt resistor and mtg clips \$21.00  
D.C. MILLIAMMETERS—G.E., DO-41, 30 MA, 3 1/2", rd & bake case ..... \$3.50  
—G.E., DO-41, 30 MA, black case, 3 1/2", rd & bake case ..... \$3.25  
—G.E., DO-41, 200 MA, 3 1/2", rd & bake case ..... \$3.25  
D.C. MICROAMMETERS—Set Carrier, 100-0-100 microampere, approximately 950 ohms resistance, 3 1/2", rd & bake case, concentric style ..... \$6.50  
—Triple, 100 ua mvt, approx. 500 ohms resist, sc cut off, 0-15 & 0-100 V MA, 4" rd & bake case, Knife edge pointer ..... \$5.50  
—G.E., DO-41, 200 microampere mvt, Knife edge pointer, sc mtd "Set Carrier" supp with caper V.O.M.A. sc, 3 1/2", rd & bake case ..... \$4.95  
A.C. VOLTMETERS—W.H., NA-35, 15 V, (100 MA) 3 1/2", rd & bake case ..... \$3.95  
—W.H., NA-35, 150 V, (10 MA) 3 1/2", rd & bake case ..... \$5.50

All items are Surplus-New-Guaranteed. C.O.D.'s not sent unless accompanied by 25% Deposit. Orders accepted from rated concerns, public institutions, etc., on open account.

The above is only a partial listing of the many items we have in stock. Send for free circular.

MANUFACTURERS, EXPORTERS, DEALERS—we invite your inquiries.  
**MARITIME SWITCHBOARD**  
336 Canal Street New York 13, N. Y.  
Worth 4-8217

## A.F. WATTMETER TESTS SPEAKERS

(Continued from page 31)

### Calibration

After the circuit is wired up and checked, the plate voltage is adjusted to 120 and the 500-ohm wire-wound (bias) potentiometer is varied until the plate meter reads just above cut-off. A slight residual reading of less than 1% of full-scale may remain but does not interfere with the operation. The impedance switch in the grid circuit is set to 8 ohms (center contact) and a variable 60-cycle voltage is applied to the wattmeter input circuit. This voltage may be from a variable toy transformer, a variac, or a voltage divided across a fixed voltage. Two 6.3 filament windings in series and correctly phased are suitable for the latter. A reliable voltmeter should be used in any case.

Fig. 2 shows required input voltages for specified plate currents. For example, a 4-volt input causes the meter to read 2.0 watts, that is 20 micro-

tentiometer. The cathode resistor has the same effect on the spread when it is decreased. A slightly different setting of the grid (2,000-ohm) potentiometer also may be tried if necessary.

After several adjustments, the wattmeter should be within 2% of the graph calibration. Still leaving the impedance switch at 8 ohms, adjust the meter to mid-scale. This requires 8.95 volts (9 volts for practical purposes). If this comes out right, throw the switch to 4 ohms and note that the plate current rises to full-scale. Now change to 16 ohms and the reading should drop to 50 microamperes. If these values are not obtained, the resistance of the input impedance loads are probably not exactly 8 and 4 ohms each.

With the 8-ohm load, the meter is direct-reading, 0-20.0 watts. Voice coils of this impedance are usually designed for a maximum of about 15 watts, so

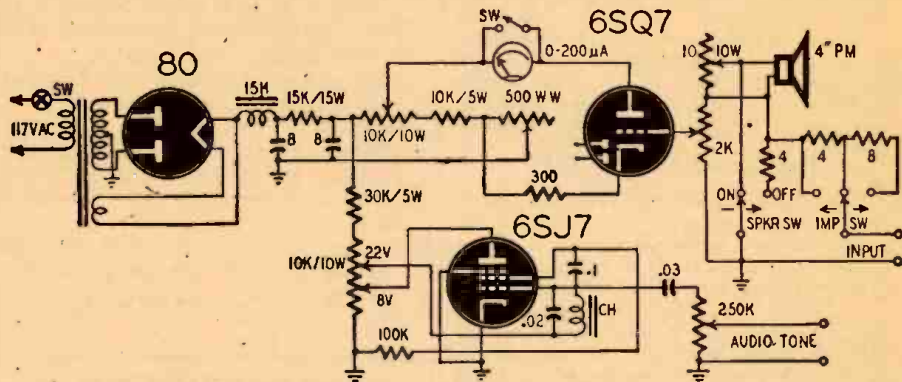

Fig. 1—Circuit of the a.f. wattmeter. The 6SJ7 is a sine-wave transistor signal generator.

amperes. The grid potentiometer may be adjusted for this value. Then as the input is increased the plate meter should show current values like those in the graph. At 12.6 volts (2 filament windings in series) the meter reads just a hair above full-scale.

With the voltages previously given the first attempt will probably give a result close to that desired. It can be improved by slight adjustments. Increasing the grid bias (and plate voltage if necessary) produces a greater spread of the readings, and vice versa. In other words, if the upper scale readings do not advance fast enough, increase the resistance of the 500-ohm po-

there is plenty to spare for peak or instantaneous values. With the 4-ohm load, the meter readings must be divided by 2 since it actually shows 0-100 watts. With the 16 ohm load, the wattmeter measures 0-400 watts so the readings must be multiplied by 2. To accommodate the high power handled the impedance switch should be of heavy construction, such as an Ohmite multitap power switch.

The auxiliary PM speaker may be switched into the circuit when an audio check is desired. It is shunted by a variable 10-ohm resistor to bring the combined impedance to 4 ohms. The shunt is correct when no change is noticed

## LOOK AT THESE SUPER-VALUES!

← RECORD PLAYER



COMPLETE AT ONLY  
**\$985 ↔ \$1475**

with tube

A complete kit at a new low price. Powerful rim drive motor. High output low pressure crystal pickup. Five inch Alnico 5 speaker. Dual tube amplifier. All wood cabinet. Durable leatherette covering. Including all necessary hardware, wire and solder. Model RP410 complete with all instructions, nothing else to buy. Ship. wt. 7 lbs.

TEST OSCILLATOR →



with tubes

Two bands, 180-575 and 575-1800 Kc. 12SK7 ECO 36Z5 rectifier and 991 modulator. Designed and priced to save you money. Kit ..... \$14.75. Wired ..... \$20.25

Terms—Cash with order or C.O.D. with 20% deposit. Send for our new bargain list.

**HALLMARK ELECTRONIC CORPORATION**  
592 Communipaw Ave., Jersey City 4, N. J.

when switching the speaker in or out. A sustained audio tone is needed for this test. Distortion may be checked with the speaker, the meter itself showing only power level.

The transitron is conventional and is included as a source of pure sine wave audio power. With the voltages shown in Fig. 1, the output has very low distortion. In some cases it may be found that the feedback is so low (for pure wave form) that the oscillator does not start. The line switch may be thrown off and then on again quickly to start it oscillating.

The choke coil in the screen circuit of the oscillator may be a small filter or transformer winding. A small inductance bypassed with a large condenser gives low distortion. The condenser may be chosen to give the desired frequency,

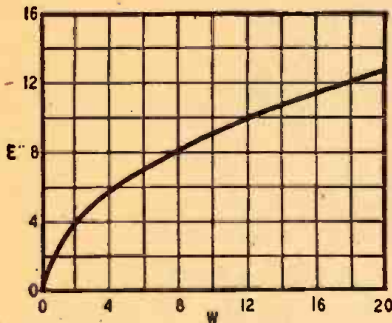

Fig. 2—Input voltage vs plate current curve.

which should be about 400 cycles. The power output is sufficient for amplifier testing.

The 10-watt voltage divider used to provide transitron voltages, as well as the other 10-watt voltage dividers in this circuit, may be of the "Dividohm" or similar type. A shorting switch is added across the microammeter to protect it when not in actual use. (When the instrument is turned off, the needle will tend to slam off scale on the lower impedance ranges.)

The wattmeter may be used not only for direct measurement of power but also for alignment or adjustment of a receiver or amplifier. Wattmeter readings are much more sensitive to changes than are voltmeter readings. For example, a 41% increase of voltage is equivalent to a 100% increase of power. Thus where a linear wattmeter will deflect from mid-scale to full-scale, the same change will only bring a voltmeter from mid-scale to less than three-quarters scale.

Amplifier distortion is checked by switching in the speaker while noting the power. It will be interesting to vary the load impedance while listening. The correct load is the one which gives minimum distortion but not necessarily greatest output.

**NOW *Sound* FOR YOUR SILENT PROJECTOR Economically**

**\$5995** Convert your 16mm silent projector to sound (regardless of make) with Apex sound head & radiofilm adapter. Guaranteed excellent performance. Write today for free information.

**APEX VIDEO • 12209 U Branford St. • Roscoe, Calif.**

Living Room Concerts

More Economical

Airport & Train Announcements

Cannot Tangle

Broadcast Station Monitoring

**Now Available! 8 HOURS OF CONTINUOUS PLAY ON THE MAGNETAPE\* RECORDER!**

Now — record and play back on this amazing instrument any sound that can be heard, and many that cannot — from a concert hall symphony, to the beat of your heart. Simple interchangeable capstans provide a choice of three tape speeds for high fidelity, medium fidelity, or up to 8 hour voice recording. The ideal recorder and playback unit for home, office, industry, and broadcast station.

Write today for our free illustrated technical catalog featuring our complete series of Magnetape Recorders, and accessory equipment. Send 25¢ in stamps or coin for our new booklet, "Elements of Magnetic Tape Recording — and 999 Applications." \* Trademark

Longer Playing Time

30 Second Rewind

Industrial Factory Work Music

Quieter Operation

Conference Recording

Passenger Entertainment

Improved Response Range

Copying Valuable Disc Records

Complete Automatic Erasing

Recorded Lectures

**AMPLIFIER CORP. of AMERICA**

398-10 Broadway
New York 13, N. Y.

**Here's how University can help you plan**

## BETTER SOUND SYSTEMS

**WITH LESS POWER!**

University speakers require minimum amplifier power. Having a higher conversion efficiency, they deliver more acoustic output per watt input, than any other speaker of comparable size and weight.

**WRITE TODAY FOR THIS HANDY SPEAKER SELECTION CHART — NO OBLIGATION!**

APPLICATION	SPEAKER MODEL	FUNCTION	POWER (APPROX)	MIN NO SPEAKERS
OFFICES STORES STOCK ROOMS	MH OR 18B	Paging and announcing. Substitute for low efficiency speakers in intercomm sys. Same as above, but distribution 360°	1.3 watts per 1000 sq ft	1
FACTORIES (light assembly) SHIPPING—RECEIVING	18B OR 18C WITH MAIN OR 18C WITH SAH OR 18C WITH SAH OR 18C 12	Paging and announcing. Same as above, but distribution 360°	1.3 watts per 1000 sq ft	1-2

**UNIVERSITY LOUDSPEAKERS, INC.**  
80 South Kensico Avenue, White Plains, N. Y.

MODEL 18B  
PRICE \$34.00

MODEL SAH  
PRICE \$37.00

**University Loudspeakers**



Ne-O-Lite Tester  
Electronic Chemical Lab.  
Needle Packet

**G-C NE-O-LITE  
TESTER**

For testing fuses, appli-  
cances and any electrical  
circuits. 90 volts to 560V  
A.C. or D.C. No. 5100

List 50c



**G-C ELECTRONIC  
CHEMICAL  
LABORATORY**

Ideal for ex-  
perimenters,  
servicemen, etc.

19 different  
bottles and  
chemicals in steel rack (free  
rack). No. 998 ....List \$11.12

**G-C SERVICEMAN'S  
PHONO NEEDLE PACKET**

For every serviceman. Easy  
to carry needles and sell on  
the job with this handy  
packet of 10 assorted types.  
No. 1432.....List \$3.50  
(RESALE Value \$9.50)



**G-C NO. 5023  
ALIGNMENT KIT**

Complete kit that  
will take care of  
most sets. Contains  
nine excellent  
tools, with leather-  
ette case.

List \$6.25



Sold by ALL Jobbers

**WRITE FOR YOUR COMPLETE NEW  
COPY OF OUR CATALOG TODAY!**

**RADIO DIVISION DEPT. D**

**GENERAL CEMENT Mfg. Co., Rockford, Ill., U.S.A.**

Manufacturers of over 3,000 products  
Sales offices in principal cities

**RADIO PROPAGATION**

(Continued from page 22)

tance of the station with which com-  
munication is to be established.

At lower frequencies the E-layer may  
enter into the picture. An E-layer chart  
in the *Predictions* helps the radioist to  
use reflections from that layer. After  
selecting the best frequency from the F  
charts, consult the E chart. If the E-  
layer muf is higher than that reflected  
by the F-layer, use the E-layer fre-  
quency.

**Adopting the predictions**

All these methods are excellent for  
transmission between 2 fixed points,  
such as 2 commercial or government  
stations. They are not so good for the  
amateur or short-wave listener. The  
amateur wants to know what frequen-  
cies to use to cover a large area—pos-  
sibly a continent—or in what direction  
to send a CQ to get results and dx on  
his transmitter's frequency. The short-  
wave listener would like to find out  
when to listen for elusive short-wave  
broadcasters. Both are on the alert for  
times when higher frequencies than  
those predicted are useful, for these are  
the periods of dx.

A few attempts have been made to  
broaden the scope of the *Predictions* to  
cover amateur and general require-  
ments. The most successful of these is  
based on the observation that a given  
muf "cloud" drifts along the earth from  
east to west, maintaining a constant  
angle with the sun. The amateur who  
works on 10 meters, for example, can  
note the area over which 30 mc or high-  
er is the muf. If this area covers the  
control points between him and any de-  
sired station, he can work that station  
on 10 meters. Another system calculates  
owf's for narrow strips along the Amer-  
ican coast and that of other countries.

The table presented here represents a  
new approach to the problem. Based on  
latitude 40 N in the western zone, a  
large number of calculations have been  
made, giving the optimum frequency for  
any part of the day for any distance and  
any direction. As conditions drift west  
with the sun, this chart will be correct  
for any part of the United States on the  
40th parallel, and approximately cor-  
rect for considerable distances north  
and south of that line.

The table shows conditions at inter-  
vals of 3 hours and at ranges from 2500  
miles (4000 km) to 12,500 miles (20,000  
km) at intervals of 2500 miles. These  
intervals are close enough to permit in-  
terpolation for times and distances be-  
tween those given. The same is true of  
directions.

Use of the table is simple. The user  
merely consults it for the current hour  
and notes the optimum working fre-  
quencies in each direction for the vari-  
ous ranges. A combination of high  
working frequencies and great distance  
spells dx. Low frequencies in a given di-  
rection indicate the limits within which  
a receiver or transmitter should be held

(Continued on opposite page)



**RCA Outdoor Speaker**

Sturdy metal case defies worst weather.  
Magnet weight 7 lbs. rated wattage 30 watts;  
complete with multiple use output trans-  
former and 8 ohm impedance voice coil. Your  
cost at Almo \$9.95. No. MI-2917-S.

**80% OFF ON POWER RHEOSTATS**

IRC 25 watt 10 ohm.....	49c each
IRC 25 watt 50 ohm.....	49c each
IRC 25 watt 25 ohm.....	49c each
Ohmite 25 watt 100 ohm.....	49c each
Ward Leonard 25 watt 25 ohm.....	49c each
Ward Leonard 25 watt 50 ohm.....	49c each
Ward Leonard 25 watt 15 ohm.....	49c each
Hardwick 25 watt 30 ohm.....	49c each
IRC 50 watt 80 ohm.....	75c each
IRC 50 watt 100 ohm.....	75c each
IRC 50 watt 185 ohm.....	75c each
IRC 50 watt 375 ohm.....	75c each
O'mite 50 watt 9.5 ohm.....	75c each
Ohmite 50 watt 20 ohm.....	75c each
Ward Leonard 100 watt 34 ohms.....	95c each
Ward Leonard 100 watt 120 ohms.....	95c each
Triplet 327T 3" 0-1.2 DC AMP.....	\$1.95
Beede 3" 0-1000 DC MA.....	2.50

10% Cash with Orders  
**ALMO** Covers the Globe  
Phone LO 3-9225

509 ARCH STREET  
PHILADELPHIA, PENN.

**Get a new  
ELECTRIC SOLDERING IRON  
FREE**

... and assemble your own  
**MAGI-KLIPS**  
Radio & Electronic Experimenter's Kit



This is the same MAGI-KLIPS Kit—com-  
plete with all parts—that we sell ready as-  
sembled for \$29.75.

In knocked-down form with full instruc-  
tions for assembly, it is now available at the  
new low price—

**\$19.75**

... complete with a new Electric Solder-  
ing Iron—the ideal iron for wiring your un-  
assembled MAGI-KLIPS Kit.

Remember, you build 18 different experi-  
ments with your MAGI-KLIPS Kit. You  
actually teach yourself radio and electronics  
and have a lot of fun at the same time.

**RADIO RECEIVER, HOME BROADCASTER, PHOTO-  
ELECTRIC RELAY, CODE PRACTICE OSCILLA-  
TOR, SIGNAL TRACER, REMOTE CONTROL RE-  
LAY, Phonograph Transmitter, Intercommuni-  
cation Amplifier, Code Transmitter, Radio Fre-  
quency Oscillator, Telephone Line Amplifier,  
Electronic Switch, Phonograph Amplifier, Tem-  
perature Control Relay, Contact Detector, Elec-  
tronic Metronome, Interval Timer (one-shot),  
Interval Timer (repeating).**

Send for your copy of FREE booklet, "Electronics  
Made Easy."

**DEER & TAYLOR COMPANY**

Dept. O 1342 Milvia St. Berkeley 9, Calif.



**SPECIAL!  
SPECIAL!  
SPECIAL!**

Highest Grade Standard Output Trans-  
formers. Push-Pull 50L6 to 4 ohm Voice  
Coil ..... 49c  
Single 50L6 to 4 ohm Voice Coil..... 39c  
Single 42, 43, 6V6, to 4 ohm V.C. .... 42c  
Filter choke 300 ohm, 70 mills, 10 hy 39c

• Include sufficient money for postage; unused  
postage refunded. • 20% deposit with order,  
balance C.O.D. Minimum order \$3.00.

Write for Giant Bargain Catalog.

**BUYERS SYNDICATE**

786 Carew Street Springfield, Mass.

**GREYLOCK  
A Dependable Name in  
RADIO TUBES**

QT. Glass, and Miniature Types.  
12SA7, 12SK7, 12SQ7, 50L6, 12AY6.  
128P6, 128E6, 35W4, 50B5 ..... each 39c  
1A7, 1A5, 155, 174, 354 ..... each 49c  
32L7, 70L7, 117L7 ..... each 59c  
All Tubes carry RMA 90-Day Guarantee

**PM SPEAKERS**

4" Alnico No. 5 .....	each \$1.19
5" Alnico No. 5 .....	each 1.29

Standard Crystal pickup for 3 Tube Amplifier 1.49

TERMS: Not C.O.D. No order accepted for less than \$5.00

WRITE FOR BARGAIN CATALOG

**GREYLOCK ELECTRONIC SUPPLY CO.**  
30 Church Street New York 7, N. Y.

A thyatron motor control announced  
by Sylvania makes it possible to op-  
erate a special electric motor at a  
speed of 120,000 revolutions a min-  
ute.



# HARD-TO-GET PARTS

## POWERFUL ALL-PURPOSE INDUCTION MOTOR

IDEAL FOR EXPERIMENTERS—101 USES



Sturdily constructed to precision standards, this self-starting shaded pole A.C. induction motor is powerful enough for a number of uses. Some of these are: Automatic Timing Devices, Current Interrupters, Electric Fans, Electric Chimes, Window Displays, Photocell Control Devices, Electric Vibrators, Small Grinders, Buffers and Polishers, Miniature Pumps, Mechanical Weighs, Sirens, and other applications.

Consumes about 15 watts of power and has a speed of 3,000 r.p.m. When geared down, this sturdy unit will constantly operate an 18-inch turbine loaded

with 200 lbs. dead weight—THAT'S POWER!  
Dimensions 3" high by 2" wide by 1 1/4" deep; has 4 convenient mounting studs; shaft 1/8" long by 3/16" diameter, and runs in self-aligning oil retaining bearings. Designed for 110-20 volts, 50-60 cycles, A.C. only. Shp. Wt. 2 lbs.  
ITEM NO. 157  
YOUR PRICE ..... \$2.95

## ULTRA MAGNET

LIFTS MORE THAN 20 TIMES ITS OWN WEIGHT

LITTLE GIANT MAGNET

Lifts 5 lbs. easily. Weighs 4 oz. Made of ALNICO new high-magnetic steel. Complete with keeper. World's most powerful magnet ever made. The experimenter and hobbyist will find hundreds of excellent uses for this high quality permanent magnet. Measures 1 1/2" x 1 1/4" Shp. Wt. 3/4 lb.  
ITEM NO. 159  
YOUR PRICE ..... \$1.50



## GENUINE MICROPHONE TRANSMITTERS



Regular telephone transmitters taken from a single telephone supply company's overstock. Work perfectly on 2 dry cells. Can be used on P.A. systems, call systems, inter-communications, etc. etc. Includes telephone circuits, house-to-house or farm-to-farm phone lines, also to talk through your own radio or as concealed dictaphone pick-up. Useful replacements for battery-operated rural telephone lines.

THESE ARE GENUINE TRANSMITTERS, MADE BY KELLOGG, WESTERN ELECTRIC AND STROMBERG-CARLSON, excellent in appearance and operation. A remarkable value and one seldom offered in these times. Shp. Wt. 1 lb.  
ITEM NO. 160  
YOUR PRICE ..... \$2.10

## AMAZING BLACK LIGHT!

Powerful 250-Watt Ultra-Violet Source



The best and most practical source of ultra-violet light for general experimental and entertainment use. Makes all fluorescent substances brilliantly luminescent. No transformers of any kind needed. Fits any standard lamp socket. Brings out beautiful opalescent hues in various types of materials. Swell for amateur parties, plays, etc. to obtain unique lighting effects. Shp. only. Shp. Wt. 2 lbs.  
ITEM NO. 87  
YOUR PRICE ..... \$1.95

## WESTERN ELECTRIC BREAST MIKE

This is the light-weight aircraft carbon microphone, it weighs only 1 lb.

Mike comes with breastplate mounting and has 2-way swivel adjustment so that it can be adjusted to any desired position. There are 2 woven straps; one goes around neck, the other around chest. Straps can be snapped on and off quickly by an ingenious arrangement.

This excellent mike can be adapted for home broadcasting or private communication systems. By dismantling breastplate, it can be used as desk mike.

Comes complete with 6-foot cord and hard rubber plug. Finished in silver-plated plate, non-rustable. Shipping weight, 2 lbs.

ITEM 152  
YOUR PRICE ..... \$1.49



## WATTHOUR METER

Completely overhauled and ready for immediate service. Designed for regular 110-volt, 60 cycle 2-wire A.C. circuit. Simple to install: 2 wires from the line and 2 wires to the load. Sturdily constructed in heavy metal case. 8 1/2" high, 6 1/4" wide, 5" deep. Wayne Sangamo or other available make Shp. Wt. 14 lbs.

ITEM NO. 33  
YOUR PRICE ..... \$7.50



## HUDSON SPECIALTIES CO.

40 West Broadway, Dept. RC-12-47, New York 7, N. Y.

I have circled below the numbers of the items I'm ordering. My full remittance of \$..... (include shipping charges in enclosure, NO C.O.D. ORDERS UNLESS ACCOMPANIED WITH A DEPOSIT.)  
OR my deposit of \$..... is enclosed (20% refund), ship order C.O.D. for balance. NO C.O.D. ORDER FOR LESS THAN \$5.00. BE SURE TO INCLUDE SHIPPING CHARGES.  
Circle Item No. wanted:  
147 159 160 87 152 33

Name .....  
Address .....  
City ..... State .....

to work or hear from stations in those great-circle directions.

A great-circle chart based on a point near the user's location is exceedingly useful for ascertaining the bearing of distant points. Less convenient is the chart published in the *Instructions*, but distances as well as directions can be obtained from it. A globe and piece of string is possibly the simplest means of finding direction and distance.

For example, to find the muf for working between New York and San Francisco at 9 p.m. Eastern Standard Time during December, 1947, first find the bearing and distance by any of the means above. The distance is between 2500 and 3000 miles, and thus fits most closely the 2500-mile table. Bearing is a little north of west (in spite of the fact that San Francisco is south of New York). At 21 hours the maximum usable frequency west is 24 mc. For reliable work this should be converted to the optimum working frequency (owf) by multiplying by 85%. The owf is then about 20.5 mc. The nearest amateur band is 14 mc, though short-wave listeners may look for Treasure Island right up to its 21-mc frequency.

Again, suppose a short-wave listener is interested in getting Shanghai or Nanking. Distance is ascertained to be approximately 12,000 km and the bearing slightly west of north. Looking at the chart, it appears that 13 mc at 9 p.m. offers the best opportunity, as read from the 7500-mile chart in the direction N. Checking with NW, the best times appear to be between 3 and 9 p.m., with a frequency as high as 33 mc at 6 p.m. However, the bearing is much more nearly north than northwest, leaving 9 p.m. the best hour.

Only one direction is given for the 12,500-mile range, as it is the same distance in all directions. There is very little difference in muf over a wide angle from NE to NW. The operator with a rotatable antenna may find it worth his while to try various paths.

## Radio Thirty-Five Years Ago

In Gernsback Publications

### HUGO GERNSBACK

Founder

Modern Electrics .....	1908
Electrical Experimenter .....	1913
Radio News .....	1919
Science & Invention .....	1920
Radio-Craft .....	1929
Short-Wave Craft .....	1930
Wireless Association of America .....	1908

Some of the larger libraries in the country still have copies of ELECTRICAL EXPERIMENTER on file for interested readers.

From the December, 1913, ELECTRICAL EXPERIMENTER:

Dr. de Forest on the Audion Amplifier.

Modern Radio-Telegraphic Receiving Sets by H. Winfield Secor.

Constructing an Oscillation Transformer by Samuel Cohen.

How to Make a Novel Wireless Recorder by Albert E. Shaw.

Effect of Sunlight on Radio Waves. Wireless Helps Explorers 800 Miles Away in Anarctic.

Learning the Radio Codes.

# LEEDS

The house you have known for 25 years



## BC-438 FREQUENCY METER

110 volt AC operated, range 195 to 215 megacycles; complete with tubes, crystal, calibration curves and schematic; only \$9.95

RC-106GA—UIHF 2 Band Receiver, battery powered Tubes 2-957, 1-1D8GT. Very easily adjusted to 2 meters. In wooden case, with schematic ..... \$3.95

### MICA CONDENSERS

Aerovox, type 1590-H-229 low loss, bakelite case; capacity 0.4 Mfd 600v EFF. 18 amps at 3000 KC; 25 amps at 1000 KC. Special ..... 95c  
0.1 Mfd 600v DC postage stamp type ..... 5c  
15 ass't silver micas, special ..... 85c

### VARIABLE CONDENSERS

100 Mfd double bearing, silver plated, Isolantite insulation; can be ganged either end—29c; 10 for \$2.50  
25 Mfd balanced stator one hole mtg. Isolantite insulation, polished plates; Swell for UIHF—29c; 10 for \$2.50

110v Pilot assemblies ..... 39c  
ARC-5 Banana plugs silver plated; doz. .... 10c  
Antenna plug 46-PS-1 for 522A ..... 15c  
RT-243 Crystal holders ..... 15c  
FUSES—8 AG 1/100 amp Inst type; doz ..... 50c

### GENERAL RADIO POWER TRANSFORMER

550-0-550 V at 100 Ma. 6.3 V at 3 amps. 5 V at 3 amps ..... \$1.95

Relays G.E. high current, 24v coil, 200 amp. contracts ..... 39c  
Sigma plug in type; 5-prong, 200 ohm. 4 Ma DC 95c  
300 ohm twin leads, outdoor or indoor, 100 ft. \$2.95  
Circuit Breaker, Heineman, 3-5-25-35-85 amp. .... 95c  
50 Millivolts, basic movement, can be used for any range, with use of shunts and resistors. .... \$1.95

## Radio Transmitter & Receiver APS 13

Tunes 410/420 megacycles; light weight airborne Radar. 17 tubes, including 5/6J6; 9/6AG5; 2/2D21; 1/VR105 and \$11.95  
30 megacycle I.F. strip. All for.....



### OIL FILLED CONDENSERS' All Standard Brand—Guaranteed

16 Mfd. 400v DC WE 98c	10 Mfd. 1500v DC. \$3.50
0.95 Mfd. 600 vDC dtr 15c	7 Mfd. 930v AC. \$1.25
0.1 Mfd. 600v DC. .... 15c	7.5 Mfd. 330v AC. \$1.25
2 x 0.1 Mfd. 600v DC 25c	1.78 Mfd. 200v AC WE 25c
1 Mfd. 600v DC. .... 25c	1 Mfd. 5000v DC. \$2.95
2 Mfd. 600v DC. .... 49c	0.1 Mfd. 7500v DC \$1.50
10 Mfd. 600v DC. .... 98c	2 x 0.1 Mfd. 7500v DC ..... \$2.00
1 Mfd. 1000v DC. .... 39c	0.2 Mfd. 8000v DC. 98c
2 Mfd. 1000v DC. .... 79c	2 Mfd. 10000v DC \$7.50
0.5 Mfd. 1500v DC. .... 25c	
8 Mfd. 1500v DC. .... \$3.25	

### General Radio Co., VARIACS

200-B 170KVA 0-135v output, 1 amp.....	\$12.50
V-5 860KVA 0-135v output, 5 amp.....	\$18.50
V-5MT 860KVA 0-135v output, 5 amp.....	\$25.00
V-10 1.725KVA 0-135v output, 10 amp.....	\$33.00
V-10MT 1.725KVA 0-135v output, 10 amp.....	\$40.00

### NATIONAL CO. PRODUCTS

ACN Verber dial 5 x 7 1/4 .....	\$2.98
AR-18 air spaced exciter coils, for 5-10-20-40-80 meters; end, center or swinging link ..... \$1.15	
XB-18 Socket for above ..... 33c	
Complete stock of NATIONAL CO. Receivers Condensers, dials and other parts ON HAND. Catalog on request	

Crystal Mike, guaranteed perfect. Use for replacement of your shot mike. Less holder. Special ..... 69c  
Octal socket, low loss bakelite molded in metal ring 1 1/4" diameter ..... 5c  
Octal socket, Isolantite molded in metal ring, 1 1/4" diameter ..... 8c

## WIRE WOUND POTENTIOMETER

100,000 ohm, precision made. G.R. type; 25 watt, 6" diameter. Brand new ..... \$1.95

Our supply of chassis, panels and cabinets, black crackle finish, are priced LOW—as usual.

If not rated 25% with order, balance C.O.D. All prices F.O.B. our warehouse New York. No order under \$2.00. We ship to any part of the globe.

# LEEDS RADIO CO.

75 Vesey Street, Dept. RC12  
CORTland 7-2612 New York City, 7

## A TWO-TUBE FM CONVERTER

(Continued from page 30)

CIRCUIT ALIGNED	DIAL POINTER	SIGNAL GENERATOR 30% Modulation Freq. Connection	TRIMMER OR SLUG ADJUSTMENT	PROCEDURE
I.f.	108 mc.	21.75 mc. Through .01-capacitor to point A or pin No. 1 of F8 tube	Bottom slug i.f. can	Adjust for maximum output.
R.f.	105 mc.	105 mc. Through 300 ohms to terminal No. 1 and terminal No. 2	Local osc. trimmer	Adjust for maximum output.
R.i.	108 mc.	105 mc. Through 300 ohms to terminal No. 1 and terminal No. 2	Antenna trimmer	Adjust for maximum output while rocking the variable condenser.

## Senco Successfully Continues Buyers Dividend Plan To Include An Exclusive Radio and Radio Phonograph Combination Buy

### 4 TUBE AC-DC SUPERHETERODYNE RADIO

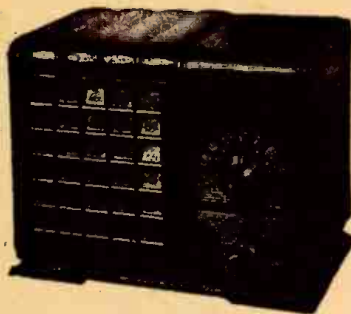

featuring Angle Dial for easy tuning

### 5 TUBE AC SUPERHETERODYNE RADIO PHONO COMBINATION



This model is a four tube superheterodyne receiver, AC-DC, giving six tube performance by the use of multi-purpose tubes, covering the frequency range of 530 to 1600 kilocycles and incorporating the features of beam power output, super-sensitive, high-efficiency, permanent-magnet dynamic speaker automatic volume control, and numerous other features producing improved performance. (Complete with tubes)

**\$13<sup>95</sup>**

This model is a five tube superheterodyne receiver, giving seven tube performance by the use of multi-purpose tubes, covering the frequency range of 540 to 1700 kilocycles Standard Broadcast and incorporating the features of beam power output, tone control on both radio and record player operation, super-sensitive, high efficiency, permanent-magnet dynamic speaker, automatic volume control, loop aerial and numerous other features producing improved performance. (Complete with tubes)

**\$29<sup>47</sup>**

### AC PHONO MOTOR AND PICKUP

60 cycles, 115 volts with Turntable **\$4<sup>35</sup>** Complete



### OUTPUT TRANSFORMERS

50LS	.....	.45 ea.
50S	.....	.45 ea.
50V	.....	.50 ea.

### SPEAKERS

4" P.M. Speaker	.....	\$1.19
5" P.M. Speaker	.....	1.16
6" P.M. Speaker	.....	1.83
8" P.M. Speaker	.....	ca. 2.73
12" P.M. Speaker	.....	.....
Alnico 5 Magnet	.....	2.49
Kit of 100 assorted insulated resistors popular ohmmeters, 1/3, 1/4 & 1 watt	.....	1.79
300 M ohm V.C. with Switch 2 1/2" Shaft Popular Brand	.....	ca. .40
40 x 40 Electrolytic Cond. 160V	.....	1.49
50 x 30 Electrolytic Cond. 150 V.	.....	1.49
Mal'oy-6 Volt 4 Prong Auto Vibrator	.....	3.10 ea.
2 Volt vibrator	.....	.99 ea.
825 Push Pull twin-mnt. Beam power amp for tube	.....	1.49 ea.

25% Deposit on All Orders—Bal. C.O.D. All Prices F.O.B. New York City

the converter was connected to an a.c. d.c. receiver, even when the plug was reversed for optimum connection.

The serviceman is likely to find this the first 1-tube-and-rectifier set he has been called on to align. Nevertheless, it is a superheterodyne and calls for standard alignment procedure, which is given in the table.

In the absence of a high-frequency signal generator, the r.f. section may be easily aligned on a local station. With the proper antenna attached, tune in an FM station, preferably between 97 and 108 mc. Note any difference in calibration and correct accordingly with the local oscillator trimmer. Then, adjust the antenna trimmer for maximum output while rocking the variable condenser.

## OPPORTUNITY AD-LETS

Advertisements in this section cost 25¢ a word for each insertion. Name, address and initials must be included at the above rate. Cash should accompany all classified advertisements unless placed by an accredited advertising agency. No advertisement for less than ten words accepted. Ten percent discount on all issues, twenty percent for twelve issues. Objections or misleading advertisements not accepted. Advertisements for January, 1948, issue must reach us not later than November 27, 1947. Radio-Craft • 25 W. 57th St. New York 7, N. Y.

AMATEUR RADIO LICENSE COMPLETE CODE and theory preparation for passing amateur radio examinations. Home study and resident courses. American Radio Institute, 101 West 63rd Street, New York City. See our ad on page 64.

MAGAZINES (BACK DATED)—FOREIGN, DOMESTIC, etc. Books, records, subscriptions, etc. Catalog 10¢ (refundable). Citicross's, 803 Fifth Ave., New York 17, N. Y.

FREE WHOLESALE BULLETIN, TUBES, PARTS, Bargain prices. Henshaw Radio Supply, 3213 Delaware City, Kansas City, Kansas.

RADIOMEN, SERVICEMEN, BEGINNERS—MAKE more money easily. \$250 weekly possible. We show you. Information free. Merrit, 215 82nd, 132nd Avenue, Springfield Gardens 13, New York, New York.

WRITE DEPT. RC 20 FOR OUR LATEST FREE BARGAIN list of Radio and Electronic parts. R.C. Radio Parts and Distrib. Co., 733 Central Ave., Kansas City 6, Kansas.

TESTING EQUIPMENT, ALL TYPES AND MODELS. Expertly repaired and calibrated. Free estimates. METROPOLITAN ELECTRONICS, 48 Weverton St., N. Y. 7, N. Y.

PRICES SLASHED—TERRIFIC BARGAINS—RADIO Supplies—Kits—Standard Tubes 60% discount—Free Bulletins—TECHNICAL LABORATORY—341 Wilson Ave. Brooklyn, N. Y.

WANTED: USED SPRAYBERRY COMPLETE COURSE. Box 192, OUrny, Colo.

\$3. COMBINATION DIRECTORY, 600 RADIO & EQUIP. Mfrs. 55 Radio Amplifiers Mfrs. 49 Radio tube-tube parts mfrs. All \$3.00. House of Buice, 60 East 42nd Street, New York 17, N. Y.

BUILD YOUR OWN RADIO'S, PHONOGRAPHS, AND Electronic Equipment. Send for our Free Gift or order complete CATALOGUE. McGee Radio, 1330 Broadway, Denver, Colorado.

YOU CAN ACCURATELY AND SWIFTLY ALIGN superheterodyne receivers WITHOUT SIGNAL GENERATOR or other expensive instruments. Complete simplified instructions only \$1. Moneyback guarantee. Chas. Gatch, 802 Ross, Pease, Mass.

3 "RADIO-BUILDERS" — See EXPERIMENTER'S Catalog free. Laboratories, Eyo-b, San Carlos, California.

28 YEARS' EXPERIENCE RADIO REPAIRING AT your fingertips. I've perfected simple system you can follow step by step. No formulas or calculations. Ours repair time to minimum. Total price \$2.00 postpaid or COD. Moneyback guarantee. Ross Radio 14615-J Grandview, Detroit 17, Michigan.

PHONOGRAPH RECORDS—DECEMBER 1947—PHONO-graph Records Catalogue. Paramount, KM-312 East Market, Wilkes-Barre, Penna.

BUILD A PORTABLE RADIO TUBE TESTER: Improved design, checks all type rectifying tubes; complete kit with easy to follow assembly blueprinting; save you \$20. Brand new factory parts. Standard Appliances Co., 1428 West Third Street, Darvon, Ohio.

TEST EQUIPMENT—BRAND NEW, FACTORY SE-conds, electrically perfect. Write for liberal discounts. Star Measurements Co., 443 East 116 St., New York, N. Y.

## 100,000 RADIO TUBES

Every tube guaranteed. Every tube in carton.

Type	Lots of 10		Type	Lots of 10	
	Each	Each		Each	Each
1U5	36	30	7AF7	44	35
1V	43	40	14X7	44	35
1L4	59	49	12A8GT	45	37
2A5	65	55	12AT6	50	45
2A6	79	69	12BA6	50	45
2X2	78	72	12BE6	50	45
3A4	89	59	12C8	49	45
3Q5GT	79	70	12J8GT	49	39
5U4G	40	40	12K7GT	45	39
5Y3GT	49	38	12K8	66	59
5Y3GT	49	38	12Q7GT	45	38
5Y4G	48	37	12SA7GT	40	32
5A7	50	48	12S8GT	40	32
6ABGT	50	44	12X7GT	45	35
6AC7	55	49	12S7GT	95	49
6AK5	73	60	2E	39	30
6AQ7/6AK7	99	79	27	42	37
6R7	53	49	41	40	35
6CS5GT	35	45	42	42	38
6C6	48	37	43	34	49
6CB8	43	37	45	49	39
6DB	45	37	47	49	39
6F8GT	45	39	62	49	39
6H6GT	45	39	57	46	39
6J50Y	45	39	58	45	39
6J7GT	42	38	71A	39	29
6K8GT	45	39	73	50	38
6K7GT	45	40	78	43	39
6L6C	98	89	77	40	32
6Q7GT	47	39	78	40	32
6U7C	40	35	89	39	31
6V6GT	45	40	83V	69	63
6X5GT	49	40	84/8Z4	35	36
6SA7GT	44	37	98	49	45
6SK7GT	44	37	25L8GT	49	39
6SL7GT	44	37	25Z5	49	45
6S17GT	49	47	25Z6GT	48	39
6SP7GT	49	47	35W4	43	40
6T7GT	44	37	35Z3	44	35
6S07	44	39	35Z5GT	43	39
6ZV5Q	45	39	35L8GT	45	39
7B6	44	35	50L8GT	50	45
7C6	44	35	117Z3	55	45
7C7	44	35	117Z6GT	59	49
7B7	44	35	50B5	42	32
7V4	44	35	32L7GT	59	49
7X7	44	35	82	59	31

# SENCO RADIO INC. 96 WARREN ST

TELEPHONE BECKMAN 3-6498

NEW YORK 7, N. Y.

## DIAMONDS

(Continued from page 19)

the circuit. The output from this tube is then applied to a two-stage amplifier, from which pulses of sufficient magnitude to operate the detecting instrument are obtained.

The pulse-producing property of the diamond is thought to be a result of its highly symmetric crystalline structure, characterized by a very regular arrangement of carbon atoms with relatively large intervening spaces. According to this theory, when a photoelectron is emitted by a diamond atom as the result of the absorption of gamma radiation the freed electron is accelerated through the interatomic space toward the positive electrode. Within a very short distance it acquires such high velocity that other atoms along its path are ionized by collision with the release of additional electrons, which in turn are accelerated in the same direction. This multiplication of charges repeats itself in rapid succession, producing a sudden avalanche of electrons equivalent to a small pulse of current. The larger the diamond the more electrons would be involved in the sudden pulse.

Apparently the diamond quickly recovers from its ionized state, as the pulses registered are extremely sharp. The diamond counter is thus a very fast counter, capable of indicating a much greater number of pulses per minute than is possible with the ordinary Geiger-Muller counter.

Diamonds tested in the Bureau's laboratories have been found to have a sensitivity per unit volume equal to or greater than that of any counter constructed by man. One of these diamonds, measuring about 1/8-inch on each face, has approximately the same sensitivity for gamma radiation as a laboratory-constructed Geiger-Muller counter of the usual type. Many diamonds are larger and would be more sensitive.

## NOW AVAILABLE! Full Range Reproduction



A revolutionary development in amplifiers cleverly designed to defy obsolescence and amazing in its performance. New circuits, new materials, and new processes are actually combined in this one amplifier to produce the most satisfying musical amplification you have ever known. If you are one of those discriminating persons for whom anything less than the best is disappointment, you are one for whom the AGA-100DC was designed. Send for technical literature.

**AMPLIFIER CORP. OF AMERICA**

398-10 Broadway, New York 13, N. Y.

# free! New! Complete!



TRouble-FREE SERVICE from STANDARD BRAND PARTS—RCA • AMPERITE • SIMPSON-JENSON • STANCOR • OHMITE • SHURE BLILEY • DUMONT • IRC • TRIPLETT • SPRAGUE and hundreds of other well known brands

## CONCORD RADIO CORPORATION

CHICAGO 7 • ATLANTA 3

901 W. Jackson Blvd. 265 Peachtree St.  
Downtown Chicago Branch—229 West Madison St.  
LAFAYETTE RADIO CORP.

# Concord Radio Catalog

160 VALUE-PACKED PAGES  
of the LATEST and BEST in  
**RADIO • TELEVISION  
ELECTRONIC EQUIPMENT**

- Thousands of items for every Radio and Electronic need.
- Special Bargains—money-saving values in top quality Radio Parts.
- Immediate delivery from huge stocks at Chicago and Atlanta.

MAIL COUPON FOR FREE COPY

CONCORD RADIO CORPORATION, Dept. RC-127  
901 W. Jackson Blvd., Chicago 7, Ill.  
Yes, rush FREE COPY of the comprehensive new Concord Radio Catalog.

Name \_\_\_\_\_

Address \_\_\_\_\_

City \_\_\_\_\_ State \_\_\_\_\_

# NEW! PRECISION ELECTRONICS inc.

## MODEL 250 SIGNAL TRACER

with 4 Stage VTVM!

**HEAR THE SIGNAL**  
**SEE THE SIGNAL**

**AUDIO INPUT**  
**POLYSTYRENE PROBE**  
**HUMLESS**  
**ISOLATED FROM AC LINE**  
**USED ON AC OR DC SETS**  
**VTVM CALIBRATED FOR AC AND DC READINGS**  
**AC OPERATED**  
**HIGHEST GAIN**  
**LOWEST INPUT CAPACITY**  
**SMALL EASY TO USE PROBE**  
**20 CYCLE TO 300 M.C.**  
**ELECTRONIC VACUUM VOLT METER—4 STAGE**  
**Only \$44.95**  
**SEE YOUR JOBBER**

**SIGNAL TRACER SPECIALISTS**

### TELEVISION RECEIVER—\$1.00

Complete instructions for building your own television receiver. 16 pages—11"x17" of pictures, pictorial diagrams, clarified schematics, 17"x22" complete schematic diagram & chassis layout. Also booklet of alignment instructions, voltage & resistance tables and troubleshooting hints.—All for \$1.00.

CERTIFIED TELEVISION LABORATORIES  
5507-13th Ave., Brooklyn 19, N. Y.

### PEN-OSCIL-LITE

Extremely convenient test oscillator for all radio servicing: alignment • Small as a pen • Self powered • Range from 700 cycles audio to over 600 megacycles u.f.z. • Output from zero to 125 v. • Low in cost • Used by Signal Corps • Write for information.

GENERAL TEST EQUIPMENT  
38 Argyle Ave. Buffalo 9, N. Y.



# HOTEL STRAND

Atlantic City's Hotel of Distinction

The Ideal Hotel for Rest and Relaxation • Beautiful Rooms • Salt Water Baths • Glass inclosed Sun Porches • Open Sun Decks atop • Delightful Cuisine • Garage on premises • Open All Year.

Write for Literature

Exclusive Pennsylvania Ave. and Boardwalk

MODEL TS-10K SOUND POWERED PHONES (NEVER USED). 28.50 pr.

### AMAZING BLACK LIGHT

Complete with resistance line cord & ultra violet ray filter. Ready to operate from your 110v. AC line. Rigid Mount ... \$2.95  
Gooseneck Mount ... \$3.40  
Replacement Bulbs — \$.35 ea.

### FILTER CHOKES

30 Henry 50 MA. 2500 volt RMS 500 ohm DC resistance. Open frame ... \$.75  
10 Henry 100 MA. 45 ohm DC resistance. Mfd. by Westinghouse, hermetically sealed ... \$.85

### WIRE WOUND RHEOSTATS

50 Watts, 8 ohms and 35 ohms ... .85  
25 Watts, 100 ohm, 25 ohm, 35 ohm, 2500 ohm ... .75

### MALLORY CAPACITORS

1100 MFD. 50 Volt ... .90  
1500 MFD. 50 Volt ... 1.10  
2000 MFD. 50 Volt ... 1.25

### SWITCHES

Slide switch: Stackpole DPDT ... .15  
SPDT momentary, center off position, long bat handle ... .29

### CONDENSERS

3 Gang Variable Condenser 50 MMFD per section Ceramic Insulation ... .63  
4 Gang Variable Condenser 50 MMFD per section Ceramic Insulation ... .85  
Oil filled condensers: .03 mfd. 7500 v. DC ... 1.15  
.30 mfd. 2000 v. DC ... .65  
1 mfd. 2500 v. DC ... 1.25  
1 mfd. 1200 v. DC ... .65  
4 mfd. 2000 v. DC ... 2.75

No sale less than \$2.00. All prices FOB New York City. 20% Deposit required with all orders.

**A. M. RADIO SALES COMPANY** 345 CANAL ST. NEW YORK CITY 13, N.Y.

## DECEMBER SPECIALS!

**SURPLUS SPECIAL**—Small 110 v. AC open frame motor, 1/2" shaft, 2700 R.P.M., 1/70 H.P. mfd. by BARBER COLMAN CO. ... \$2.00 ea.

### KNOBBS

Large skirt knobs 2" diam. 1/4" shaft ... .25  
Finger grip knobs 1 1/2" - 1/4" shaft ... .12  
Red Bar knob 2 1/4" long 1/4" shaft ... .10

### MISCELLANEOUS

PL259A Coax Connector and Socket, "Silver Plated for RG8U and RG11U ... .50 pr.  
3AG fuse holder. Mfd. by Littelfuse ... .20  
Flexible shafts, 4 1/2 inches long ... 8 for  
Grounding straps, heavy flexible wire, lugs both ends—4 inches long ... .65  
Mic trimmers: Variable 3-30 MMfd 4 gang ... .20  
Variable capacitor 4-30 mmf. 7-45 mmf. ... .25  
4 Gang dial assembly 1 : 1 ratio. Ideal for centralizing controls using flexible shafts ... 1.25  
Filament Transformer: 5 volts @ 4 amp. 110 volt pri. open frame, porcelain standoffs. Mfd. by G.E. ... 1.00  
0 to 15 DC Milliammeter. Simpson 8 1/2" Bakelite case ... 2.95

### SYNCHRONOUS MOTOR

1/2" shaft 110 v. AC 60 cy. 1 RPM, 2.2 watts. Mfg. by Hayden Mfg. Co. ... 1.25

## CRYSTAL OSCILLATORS

(Continued from page 29)

harmonics also produce parasitic output. The action is somewhat more subtle than with the triet. Removing the crystal generally stops all oscillation, at least until a condenser is put back into the grid circuit! Broadness of output tuning is the give-away symptom of trouble. Crystal currents are very low with this hookup, but at the cost of low output. Incidentally, with the 59, 802, and RK25, external feedback between grid and plate (a few  $\mu$ fs) must be used to make the unit oscillate.

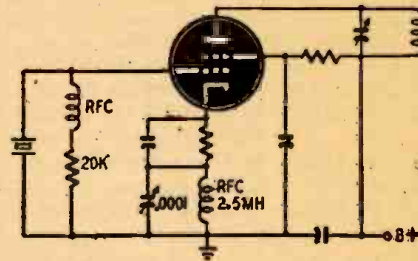

Fig. 3—Another popular harmonic generator.

Additional checks were run with several of these 20-meter crystals that are actually ground to 1/3 their marked frequency. Using an 80-meter cathode coil, the output of these crystals on 20 was slightly higher (with the single exception of the 59 to the contrary) in triet than in a TPXG circuit, with only a modest increase in crystal current.

Ten-meter output could be obtained from these crystals with a 20-meter cathode coil subject to similar limitations as to parasitic activity as with the 40-meter fundamental crystals. Unfortunately, however, the good screening characteristics of the 59, 89, 802, and RK25 have an adverse effect in this instance, resulting in negligible output. The 6L6 with its shell tied to B-plus emerged as the only stable tube, it provided generous output with moderate crystal current.

Summing up: The "good behaviors" (the 59, 89, 802, and RK25) are the most reliable, safest, and most flexible tubes for use on all harmonics and the fundamental in all types of circuits and conditions with the single exception just mentioned. The 6L6 acquires itself particularly well on most counts and would seem to be the only tube capable of providing appreciable 4th-harmonic output without too high voltages, but the requirement of returning the shell to B-plus is not a desirable one. All beam-type tubes have to be handled with care, as they are marginal cases of instability at best. Any tendency to self-oscillate can be checked by grounding the control grid and searching carefully for output with the crystal removed.

Returning to the "big four"—the 89 must be operated at lower potentials than the others. About 300 volts on the plate and 200 on the screen is the maximum or the tube will overheat, seize up, and oscillate only intermittently.

## LEARN

# ELECTRICITY OR RADIO

... in the GREAT SHOPS OF COYNE

Train in a Few Short Weeks

Here at Coyne in a few short weeks you can train for your big opportunity in Electricity or Radio. You train on actual full-size Electrical or Radio equipment. 48 years training experience. For Veterans and non-veterans.

### NOT A "HOME-STUDY" COURSE

All Coyne training is given here in our big Chicago shops. Not a Correspondence course. VETERANS! Coyne is authorized to train Veterans under the G.I. Bill. Coupon brings details.

**FREE BOOK**—Two great opportunity fields—rush coupon for free illustrated book on whichever course you prefer—no obligation. Tells how Coyne helps you get better jobs.

Your Choice of 2 Great Fields

E. W. COOKE, Pres. COYNE ELECTRICAL SCHOOL, Dept. 87-78H, 590 S. Paulina St., Chicago 12, Ill.

Send FREE BOOK and full details on course checked:

ELECTRICITY  RADIO

NAME.....

ADDRESS.....

CITY..... STATE.....



## BARGAIN SPECIALS

### The FINEST in HEADPHONES



Type P23. The Choice of the Air Corps headphones, highly sensitive, 8000 ohm impedance, bipolar magnets. Extremely comfortable sponge rubber ear cushions—stainless steel leather covered headband—concealed terminals—Six Foot Cord with PL55 plug. EVERY ONE BRAND NEW in Original Factory Cartons.

Stock No. 5A134 513.50. value. An Outstanding Buy, Only..... \$2.95

### 12 1/2 Ft. ANTENNA TELESCOPES DOWN to 1 Foot 4"



"Just it" for mobile equipment, portable receivers and transmitters. Ruggedly constructed—smooth telescopic action from 16 inches to 12 1/2 feet. Base is 3/8" in dia. with 3/8" threaded shank. By adding eyelets it makes an ideal compact fish pole. An Outstanding Value No. 38A39, Only..... \$1.95

ORDER NOW, from this ad Add Postage



**BURSTEIN-APPLEBEE**  
1012-14 MCGEE STREET, ST. LOUIS, MO.  
KANSAS CITY 6, MISSOURI

# S.S.S.

"Servicing by Signal Substitution"

Learn about this modern dynamic approach to radio servicing with ONLY BASIC TEST EQUIPMENT.

... Fully described in a 120 page book available from your Precision Distributor at factory at 35¢.

... Schools are invited to inquire regarding quantity orders from our Educational Division.

**PRECISION**

APPARATUS COMPANY INC.  
ELMHURST 4, N. Y.

Manufacturers of Fine Test Equipment  
RADIO • TELEVISION • ELECTRICAL • LABORATORY

**BE YOUR OWN BOSS!**

**MAKE MORE MONEY**



\$1.00 VALUE

**25¢**

40,000 WORDS IN TEXT

NO ADS ALL MEAT!

In "CASH IN" you now get THE real money-makers — dozens of profitable tested mail order plans, confidential business secrets, dozens of practical tested formulas, successful tested schemes — unusual experience of men who have started on a shoe-string with less than \$10 capital. 25¢ a copy postpaid. Send U. S. stamps, money order, or coin.

**Money Back Guarantee**

NATIONAL PLANS COMPANY

Box 26RA, Ansonia Station New York 23, N. Y.

## TUBULAR ELECTROLYTICS

Fresh stock Fully guaranteed

20 mfd. 150 V. .... 10 for \$1.79  
20-20 mfd. 150 V. .... 10 for 2.49  
8 mfd. 450 V. .... 10 for 1.85

Postage extra. 25% deposit on COD.

Write for our free bargain lists featuring "AMERICA'S BEST BUYS"

**POTTER RADIO CO.**

1312-1314 McGee St. Kansas City 6, Mo.

## RADIO & ELECTRONIC BARGAINS

Dual L pad for spkr. voice coil vol. control. 89¢  
5 watts, #L01 ..... \$1.49  
Triple 75 ohm T pad 8 watts long shaft #L03 ..... 3.49  
Weston 3 1/2" Type 801 50-0-50 ma #M11 ..... 17.50  
10a Transat Amertran 115v 50-600 in. O-130v  
10 amp out panel or bench mtg #T22 ..... 2.25  
Hi Voltage Trans, 110v 50-60 o In 1200v 12 ma  
out #T31 ..... 2.25

Write for additional bargains in parts and kits designed by ROBERT G. HERZOG.

**UNIVERSAL GENERAL CORP. (DEPT. CR)**  
365 Canal Street, New York 13 Walker 5-9642

## ROTA-BASE

NEW HANDY LAB. DIAL actually gives a "prong" picture of radio tube connections. INSTANTLY, ACCURATELY. No more valuable time lost thumbing pages or on lengthy readings. Filament, grid, plate, cathode, etc. to more than 300 tube types are shown. NOW ONLY \$1.00 postpaid, or sent C.O.D. plus postage. Order TODAY, money refunded if you are not delightfully pleased.

**REED MFG. CO.**

11350Y Burbank Blvd. N. Hollywood, Calif.

## ARE YOU GETTING OUR FLYERS???

If not, PRINT your name and address on a penny postcard. It will mean dollars in the bank for you!! Ask for our latest catalog and flyer. Dept. RC

**RADIO EQUIPMENT CO.,**

377 E. Main St., Lexington, Kentucky  
"YOUR FRIENDLY PARTS HOUSE"

## RADIOMEN SERVICEMEN BEGINNERS

**MAKE MORE MONEY**

**EASILY — QUICKLY**

**\$250. WEEKLY POSSIBLE**

We Show You How Information Free

**MERIT PRODUCTS**

216-32V 132 AV, SPRINGFIELD GARDENS 13, N.Y.

## COMMUNICATIONS MEET CLEARS ETHER PATHS

**A**CCOMPLISHMENTS of the International Telecommunications Conference, which completed its work at Atlantic City in October, include the important work of conserving space in the radio spectrum and insuring its most efficient use. Charles R. Denny, chairman of the conference, reported gains in 3 important respects:

"First" he said, "we have adopted a world-wide frequency allocation table extending up to 10,500 mc.

"Second, we have planned practical machinery for putting this new allocation table into effect. Until now, every country using frequencies has simply notified the headquarters of our Union of the assignments to be entered on a master list. There was no concerted international effort to make arrangements which would best conserve spectrum space. There was no planned sharing of frequencies on a time basis or on a geographical basis. Frequency assignments spilled over the available spectrum space, radio interference became widespread, and the world was deprived of the full advantages of which radio is capable. To meet this situation, we are providing for a Provisional Frequency Board which will be comprised of technical experts. It will be the task of this Board to re-engineer the operating assignments throughout the world so that they will be put on a sound engineering basis so as to conserve spectrum space and eliminate interference.

"Third, we have provided for a permanent board of experts, the International Frequency Registration Board, which, starting with the newly-engineered list of frequency assignments, will consider every future assignment to determine whether it will cause international interference."

Numbers of delegates hailed the establishment of the International Frequency Registration Board as one of the most important results of the Conference, pointing out that it would insure uniform application of modern standard methods of radio communication throughout the world and would make possible the best use of available channels, as well as provide solutions for interference problems.

## Reserve Your Special TELEVISION ISSUE NOW!

The January RADIO-CRAFT will be twice the regular size and will feature the Progress of Television with many articles on television theory, construction, equipment and operation. Order your copy from your regular newsdealer now!

## ILLINOIS CONDENSER CO.

NOW HAS **UMP!**

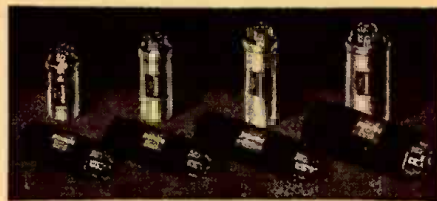

TYPE UMP

A popular replacement twist prong line of COMPACT, HERMETICALLY SEALED, efficient, dry electrolytic condenser, is now a member of the ILLINI line of highest quality capacitors.

The "Illini" UMP capacitors are now available at your local jobber. Our latest catalog, listing complete Illinois line, will be mailed to you upon request.



**ILLINOIS CONDENSER CO.**  
1616 NORTH THROOP STREET - CHICAGO 22, ILL.

## RADIO TUBES

For immediate shipment

R.M.A. Guaranteed  
Below Distributor Costs  
Individually Sealed Cartons

Type	Price
6K6GT	.40
6K5GT	.46
6V6GT	.46
6SA7GT	.46
6SJ7GT	.46
6SK7GT	.46
6SQ7GT	.46
6X5GT	.40
12SA7GT	.46
12SQ7GT	.46
12SK7GT	.46
12SJ7GT	.46
35L6GT	.40
35Z5GT	.32
50L6GT	.46

RATED ACCOUNTS—2% 10 DAYS  
ALL OTHERS 2% C.O.D.  
10% DISCOUNT ON LOTS OF 50 OR MORE

**RAVAC ELECTRONICS CORP.**

432—4th Avenue  
New York 16, N. Y.

# THIS RECORDER HAS EVERYTHING

(INCLUDING A RECORD PLAYER)

**Build Your Own Wire Recorder and Save Money**

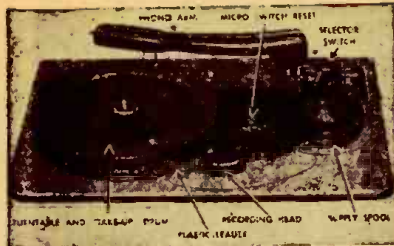

Model B-1 Magnetic Wire Recorder (Foundation Unit) records up to 1 hour continuously. Full range fidelity 80-8000 CPS records from standard phono records, radio or microphone. This model uses two motors—one for play-recording, second motor for recording. Connect to amplifier or radio. Model B-1 (as illustrated above) with crystal mike, 1 hour spool of wire, phono pickup, 40 K.C. oscillator, wired and tested, and schematic diagrams.

1 Model B-1 .....\$65.00  
2 Model B-1's ..... 60.00 each  
3 Model B-1's ..... 55.00 each

Note that the above quantity prices will only prevail while our present stock of Wire Recorders lasts. Prices will go up again after these have been disposed of. See your friends and act now. A diagram of a simple 4-tube amplifier for portable usage to connect to this Recorder can be had by requesting same.

Quantity Sales ordered in name of one customer shipment will be made to same. Remit payment in full for Recorders with order. All Recorder sales are final.



N-110 Western Electric Sound Powered Microphones. These can be used with P.A. and Recording systems. Good frequency response. Complete with chest plate and 20 feet of high grade low impedance microphone cable \$5.00 each; with 50 feet length of cable \$8. The microphone cable alone is worth more than the purchase price.

National Union Radio Tubes Standard individually cartoned 1 tube 5¢. Discount 50% plus 10% from current 50 tubes. Mail your order

sent list prices. Minimum order promptly with remittance.

30% Deposit with C.O.D.

Minimum Order \$3.00

Recorder orders remit in full.

**ELECTRONICS OF STATEN ISLAND, N. Y.**

(Formerly Clarion Sound Eng. Co.)

P. O. Box 169 Staten Island 1, N. Y.  
Gibraltar 7-8975

## EASY TO LEARN CODE

It is easy to learn or increase speed with an Instructograph Code Teacher. Affords the quickest and most practical method yet developed. For beginners or advanced students. Available 1 tube from beginner's alphabet to typical messages on all subjects. Speed range 5 to 40 WPM. Always ready—no QRM.

**ENDORSED BY THOUSANDS!**

The Instructograph Code Teacher literally takes the place of an operator-instructor and enables anyone to learn and master code without further assistance. Thousands of successful operators have "acquired the code" with the Instructograph System. Write today for convenient rental and purchase plans.

**INSTRUCTOGRAPH COMPANY**

4701 Sheridan Rd., Dept. RC, Chicago 40, Ill.

## BE YOUR OWN AUTO MECHANIC

**Henley's Books Will Help You!**

**HOW TO TUNE UP YOUR AUTOMOBILE**

239 Pages—194 Illustrations \$2.50

**HOW TO FIND A SHORT AND OTHER WIRING TROUBLES**

209 Pages—82 Illustrations \$2.00

**FORD V8 CARS AND TRUCKS**

1932 to 1940 Models

Construction—Operation—Repair

823 Pages—369 Illustrations 3.50

**CHEVROLET SIX CARS AND TRUCKS**

1930 to 1940 Models

Construction—Operation—Repair

896 Pages—363 Illustrations 3.50

Books Sent Postage Prepaid. Send For Catalog of Technical Books.

Dept. R.C.

**THE NORMAN W. HENLEY PUBLISHING CO.**

17 West 45th Street New York 19, N. Y.

Watch for the special January Television Issue!

# Communications

A LETTER FROM BENJAMIN F. MIESSNER

Dear Editor:

Your September RADIO-CRAFT is especially interesting to me because:

1. On page 18, the story on the photoelectric proximity fuze is much like the scheme described in my book *Radio-Dynamics* (1916) for target-seeking missiles, which used the photoelectric stimulus of an aircraft silhouette against a bright sky as a means for automatic guiding, with 2 pairs of photoelectric cells at right angles, and with appropriate relays and guiding controls.

2. On page 34, Mr. Straede's article *Response Equalization*. I used similar methods in 1920-22 (in what I believe to be the earliest electrophonographic recording) while head of the acoustical

research laboratory of the Brunswick Phonograph Company in Chicago. I went even further, using tuned, resonant, a.f. circuits, with correct resistance, not only for reducing resonant overresponse in microphones and cutter heads, and for building up weak responses in the over-all frequency-response characteristic of the entire recording system; but also to correct, in the record, reproduction for similar variations in the reproducer.

3. The article on *Post-War Phonograph Pickups* describes the FM pickup on which I hold several patents.

I always enjoy RADIO-CRAFT.

B. F. MIESSNER,  
Morristown, N. J.

## SIMPLE BOOKS SOLVE BEGINNERS' PROBLEMS

Dear Editor:

I have little fault to find with the last few issues of RADIO-CRAFT. There have been articles for servicemen and hams and also engineers, besides material to widen the beginners' scope of knowledge.

When I was a beginner, I hunted through libraries for books and built every 1-, 2-, or 3-tube ever dreamed of. Then I wished there was a magazine devoted to set builders and experimenters, without so many advanced articles. Now I'm on the other side of the fence. I wish there was a magazine that dealt entirely with service and advanced data. I know that would be nearly impossible from the publisher's point of view.

I believe the beginner can get his 1-tube and crystal circuits from RADIO-CRAFT books. They are available to any beginner at all times, while an article in the magazine would be read by only a few of them, and a month later another group would want the same information. Get the idea? There were no RADIO-CRAFT books in my day!

I always mention them to a beginner, and I help any one of them today, if he is a child or aged person, to make a 1-tube set or superhet, and try to explain what he wants to know. More power to the beginner!

W. G. ESLIK,  
Casper, Wyoming



Suggested by:  
Walter Price,  
New York, N. Y.

"I want a Teleset so that they can see me at the Television Studio."

**STATEMENT OF THE OWNERSHIP, MANAGEMENT, CIRCULATION, ETC., REQUIRED BY THE ACT OF CONGRESS OF AUGUST 24, 1912, AND MARCH 3, 1933.**  
Of Radio-Craft and Popular Electronics, published monthly at Springfield, Mass., for October 1, 1947.

State of New York  
County of New York

Before me, a Notary Public in and for the State and county aforesaid, personally appeared Hugo Gernsback, who, having been duly sworn according to law, deposes and says that he is the editor of Radio-Craft and Popular Electronics, and that the following is, to the best of his knowledge and belief, a true statement of the ownership, management (and if a daily paper, the circulation), etc., of the aforesaid publication for the date shown in the above caption, required by the Act of August 24, 1912, as amended by the Act of March 3, 1933, embodied in section 537, Postal Laws and Regulations, printed on the reverse of this form, to wit:

1. That the names and addresses of the publisher, editor, managing editor, and business managers are: Publisher, Radecraft Publications, Inc., 25 West Broadway, New York 7, N. Y.; Editor, H. Gernsback, 25 West Broadway, New York 7, N. Y.; Managing Editor, Fred Shannaman; Business Managers, none.

2. That the names (if owned by a corporation, its name and address must be stated and also immediately thereunder the names and addresses of stockholders owning or holding one per cent or more of total amount of stock. If not owned by a corporation, the names and addresses of the individual owners must be given. If owned by a firm, company, or other unincorporated concern, its name and address, as well as those of each individual member must be given.) Radecraft Publications, Inc., 25 West Broadway, New York 7, N. Y.; H. Gernsback, 25 West Broadway, New York 7, N. Y.

3. That the known bondholders, mortgagees, and other security holders owning or holding 1 per cent or more of total amount of bonds, mortgages, or other securities are: (If there are none, so state.) None.

4. That the two paragraphs next above, giving the names of the owners, stockholders, and security holders, if any, contain not only the list of stockholders and security holders as they appear upon the books of the company but also, in cases where the stockholder or security holder appears upon the books of the company as trustee or in any other fiduciary relation, the name of the person or corporation for whom such trustee is acting, is given; also that the said two paragraphs contain statements embracing affiant's full knowledge and belief as to the circumstances and conditions under which stockholders and security holders who do not appear upon the books of the company as trustees, hold stock and securities in a capacity other than that of a bona fide owner; and this affiant has no reason to believe that any other person, association, or corporation has any interest, direct or indirect, in the said stock, bonds, or other securities than as so stated by him.

5. That the average number of copies of each issue of this publication sold or distributed, through the mails or otherwise, to paid subscribers during the twelve months preceding the date shown above is .....

(This information is required from daily publications only.)  
(Signature of Publisher)  
H. GERNSBACK

Sworn to and subscribed before me this 12th day of September, 1947.  
MAURICE COYNE, Notary Public.  
(Commission expires March 30, 1948)

### STAMP MODEL NUMBERS!

Dear Editor:

May I suggest you get after the set manufacturers and tell them to please stamp the model number and year of manufacture on their chassis? Many sets are still made with the model number pasted on, or printed on a label pasted in the cabinet. It soon falls off, and I have had several chassis without identification, some of them made by the leading manufacturers. This can cause delay in servicing the receivers, and consequent bad will toward the brand.

Volume controls should also have the number and resistance plainly printed on them.

I have had many complaints from customers about the short-wave bands included with broadcast receivers. The public wants AM and FM and no short wave in their new receivers.

E. C. FREISEN,  
Detroit, Michigan

### A CORRECTION

In the circuit diagram of the "Scotch Receiver" shown on page 35 of the October 1947 issue the 500,000-ohm resistor in the grid circuit of the 12A6 is shown connected to the B-plus line. The bottom end of this resistor should be grounded or connected to the common negative point in the set.

We thank Mr. Robert Kendall of Columbus, Ohio, for calling this to our attention.

## RANGE MASTER MODEL 10 A PRECISION INSTRUMENT THAT YOU CAN BUILD YOURSELF

**FOR RADIO TESTING  
APPLIANCE REPAIRING  
AMATEUR &  
EXPERIMENTAL WORK**

**BRADSHAW INSTRUMENTS CO.**  
942 King's Highway Brooklyn 23, N. Y.

SEND FOR DESCRIPTIVE LITERATURE

**RUGGED!  
DEPENDABLE!!!  
ACCURATE!!!**



**COVER THESE RANGES**  
A.C. VOLTAGE: 1-10-100-500-1000 Volts  
D.C. VOLTAGE: 10-100-500-1000 Volts  
A.C. CURRENT: .15-1.5-15 Amperes  
D.C. CURRENT: 1-10-100-1000 Milliamperes  
RESISTANCE: RX10 RX100 RX1,000 Ohms  
CAPACITANCE: .001-.1 .01-1.10 Mfd.

Complete Kit & Instructions .. \$17.95  
Factory Built ..... 23.50  
Test Leads ..... .85  
Foundation Meter & Instructions 7.85  
2% Sales Tax in N.Y.C.  
DEALER INQUIRY INVITED



**HERE'S a new and highly profitable business that's a dead natural for**

the radioman who wants to supplement his income with a minimum investment in both time and money. Today, individuals like yourself, all over the country, are realizing big dividends with TRADIO, the radio functionally-designed for coin operation in hotels, tourist camps, hospitals, etc. And they're doing it right in their own backyards, too.

### • Big Earnings, Steady Income

TRADIO has pioneered in this new and flourishing post-war field. Sit in on the ground floor and assure yourself of financial security for life.

### Tradio \* Tried \* Tested \* Proven

TRADIO sells to operators only through franchised distributors. No routes are sold. We'll put you in touch with the distributor in your territory if you'll phone Asbury Park 2-7447 or write Dept. U-11.



**TRADIO, Inc.** ASBURY PARK NEW JERSEY

## Get Started in Radio

**10 "HOW-TO-DO-IT" BOOKS**  
Get a solid foundation in radio by means of these 10 timely text books. Each clearly written, profusely illustrated, contains over 15,000 words. You'll be amazed at the wealth of information packed into these handy books. Excellent for reference—ideal for technical library. Your money back if not satisfied.

**5 BOOKS for 50c  
10 BOOKS for \$1.00**

**Sent to You Postpaid**  
No. 1—How To Make Four Binary (Leading Terms) No. 6—How To Have Fun With Radio  
No. 2—How To Make The Most Popular All-Wave 1 and 2 Tube Receivers. No. 7—How To Read Radio Diagrams  
No. 3—Alternating Current for Beginners No. 8—Radio for Beginners No. 9—Electric Electrical Experiments  
No. 4—All About Aerials No. 10—Television  
No. 5—Beginners' Radio Dictionary  
Remit by check or money order—enclose letter if you send cash or stamps.

**RADIO PUBLICATIONS**  
25A West B'way, New York (7)

### Answers to Quiz on page 83

1.—1; 2.—3; 3.—1; 4.—3; 5.—4; 6.—2; 7.—2; 8.—2; 9.—3; 10.—60 cycles.

Don't forget to refer to the **RADIONIC** Catalog!

... BECAUSE IT'S ONE COMPLETE COMPREHENSIVE RELIABLE VOLUME

PARTS AND ACCESSORIES • TEST INSTRUMENTS • RADIOS • TELEVISION COMPONENTS • INTER-COMMUNICATORS • RECORDERS • PUBLIC ADDRESS • TUBES • HARDWARE • RECORD CHANGERS • TECHNICAL BOOKS

Chancellor Radio

**RADIONIC EQUIPMENT COMPANY**

DEPT. 112 TRIBUNE THEATRE ENTRANCE 170 NASSAU ST. N. Y. 7, N. Y. WORTH 2-0421

RADIONIC EQUIPMENT CO., DEPT. 112 170 Nassau Street New York 7, N. Y.

Send immediately your FREE catalog listing products of radio's leading manufacturers of parts and equipment and numerous special items at bargain prices.

Name .....  
Address .....  
City ..... State .....

**MAIL TODAY**

**2-IN-1 CHANNEL ANALYZER  
NEW PENCIL THIN PROBE**



Extremely sensitive tracer permitting signal to be heard at any stage of radio under test. Uses New Pencil Thin Probe with loud speaker operation.

Plus a signal generator that delivers a strong A.F., I.F., and R.F. Signal, permitting the serviceman to trace and align any portion of receiver under test. Uses a multi-vibrator network.

A.C. D.C. operated. Only two controls for complete operation.

Serviceman's net price \$14.95

Write for Illustrated Literature

SEE YOUR LOCAL JOBBER if he can't supply you write us direct.

**CONSTANT ELECTRIC**

112 Cornelia St. Brooklyn 21, N. Y.

# RADIO SCHOOL DIRECTORY

PREPARE NOW FOR SKILLED JOBS IN RADIO AND ELECTRONICS

## PRACTICAL TECHNICAL TRAINING

SPECIALIZE in 6 months to 3 years

### COURSES

#### SERVICE

- 6 to 12 Months
- Electricity
- Welding
- Refrigeration
- Heating

#### TECHNICIAN

- 1 to 2 Years
- Electricity
- Radio
- Electronics
- Refrigeration, Heating and Air Conditioning

#### PROFESSIONAL

- 3 Years
- Electrical Engineering Bachelor of Science Degree
- Major in Machinery or Electronics

Train in Electronics, Radio, Electricity for a substantial career in industry—or a business of your own. Prepare in one year to be a Technician—or in two additional years secure a Bachelor of Science Degree in Electrical Engineering with major in Electronics. More than 35,000 former students in industries the world over. 1,292 students now enrolled from 48 states and 8 overseas countries. Faculty of 72 specialists. Write for catalog and Personal Guidance Questionnaire.

Terms start January, April, July.

**MILWAUKEE**  
**SCHOOL of ENGINEERING**  
A TECHNICAL INSTITUTE

Dept. RC-1247 North Broadway, Milwaukee, Wis.

### SPECIALIZED TRAINING

Graduates employed as Airline Flight and Marine Radio Officers, Broadcast Engineers, CAA and Police Radio Operators, Radio-Television Technicians, Radio Shop Owners. Practical training by specialists.



Modern equipment in Servicing, Television and Communications Laboratories. New classes monthly. Limited enrollment. Send for Free 16 Page Illustrated Catalogue. Approved for veterans.

**WESTERN RADIO COMMUNICATIONS INSTITUTE**  
631 W. Ninth St., Los Angeles 15, Cal. Dept. O.  
Member, L. A. Chamber of Commerce

## TELEVISION

Practical and Theoretical Technicians Course, covering all phases of Radio, Frequency Modulation, Television, leads to opportunities in Industry, Broadcasting or own Business. Day and Eve. Sessions. Licensed by N. Y. State. Approved for Veterans. **ENROLL NOW FOR NEW CLASSES** Visit, Write or Phone

**RADIO - TELEVISION INSTITUTE**

Pioneers in Television Training Since 1933  
480 Lexington Ave., N. Y. 17 (46th St.)  
Plaza 3-4585 2 blocks from Grand Central

## CAREERS in RADIO

INTENSIVE COURSES—Thorough, technical education for progressive men and women.

Licensed by the State of New York

- 1. RADIO TECHNICIAN**—The MRI General Course. Includes F.M. & Television. Prepares for FCC Broadcast Licenses.
- 2. RADIO & TELEVISION SERVICING**—Prepares for employment as Repairman on Standard Broadcast, F.M. & Television Receivers.
- 3. RADIO COMMUNICATIONS**—Prepares for FCC Operators' License. Leads to position as Merchant Marine or Flight Radio Officer; Commercial Operator.
- 4. FUNDAMENTAL RADIO MATHEMATICS**—The MRI Preparatory Course. Required pre-training for students lacking a basic mathematical background.

### MELVILLE RADIO INSTITUTE

MELVILLE BUILDING  
15 WEST 46TH ST., N. Y. 19. BR 9-5080  
"The Radio School Managed By Radio Men"

### MELVILLE RADIO INSTITUTE

MELVILLE BUILDING  
15 West 46th St., N. Y. 19, N. Y.

GENTLEMEN: RC  
Send me FREE information about your school.

Name.....

Address.....

MAIL THIS COUPON NOW

## RADIO

TECHNICIAN and RADIO SERVICE COURSES  
**FM and TELEVISION**

AMERICAN RADIO INSTITUTE

101 West 63rd St., New York 23, New York  
Approved Under GI Bill of Rights  
Licensed by New York State

## SOUND RECORDING SCHOOL

A practical 9 months' course in Sound Fundamentals, Recording, and Sound Transmission measurements; in a laboratory containing transmission sets, oscillators, square wave generator and intermodulation analyzer, and other equipment.

Two complete recording studios assimilating broadcast, motion picture and commercial sound recording, under the direction of E. M. Tremaine.

Approved for Veterans  
**DON MARTIN SCHOOL OF RADIO ARTS**  
1655 Cherokee St., Hollywood, Calif.

## RADIO ENGINEERING I

Complete Radio Engineering Course. Bachelor of Science Degree. Courses also in Civil, Electrical, Mechanical, Chemical, Aeronautical Engineering; Business Administration, Accounting, Secretarial Science. Graduates successful. 64th year. Enter Jan., March, June, Sept. Write for catalog.

**TRI-STATE COLLEGE** 2491 College Ave. ANGOLA INDIANA

DEGREE IN 27 MONTHS

## Radio Technician and Announcers

A practical 15-month course in First Class Radiotelephone Operation and Announcing is offered by Don Martin School of Radio Arts. Most stations these days require combination men. We specialize in this type of training and maintain a placement bureau for our graduates. Serving the industry for 10 years, the School of Radio Arts can train you. Write for our catalogue outlining the courses offered. Classes can be arranged so you can do part time work on the side.

APPROVED FOR VETERANS

**DON MARTIN SCHOOL OF RADIO ARTS**  
1655 North Cherokee St. Hollywood 28, Calif.

### CORRESPONDENCE COURSES IN RADIO and ELECTRICAL ENGINEERING

**ELECTRICAL ENGINEERING** Get Good Grasp of wide electrical field. Prepare yourself at Low Cost, for secure future. Modern course. So simplified anyone can understand quickly.

**RADIO ENGINEERING** Extra fine course in radio, work. Trains you to be super-service man, real vacuum tube technician. Servicemen needed badly. Diploma on completion. Many graduates earning big pay.

WRITE about deferred payment plan, experimental kits, etc. \$25 Either Send postcard for Free Copies of school catalog, full details, all \$25 Course Lincoln Engineering School, Box 931C-106, Lincoln 2, Nebr.



### RCA INSTITUTES, Inc.

Offer thorough training courses in all technical phases of

**Radio and Television**

DAYS-EVENINGS WEEKLY RATES

**VETERANS:** RCA Institutes is approved under G. I. Bill of Rights

For Free Catalog Write Dept. RC-47

**RCA INSTITUTES, Inc.**

A Service of Radio Corporation of America  
78 VARICK STREET NEW YORK 18, N. Y.

### LEARN

## RADIO

Get F.C.C. License  
**RADIO — TELEVISION**  
Repairing

Classes start every month

Our organization engaged in **TECHNICAL TRAINING** for 27 Years  
LITERATURE ON REQUEST

**BALTIMORE TECHNICAL INSTITUTE**  
1425 Eutaw Place. Balto. 17, Md.  
**APPROVED FOR VETERANS**

## COMMERCIAL RADIO INSTITUTE

A radio training center for 27 years.

### RESIDENT COURSES ONLY

Broadcast, Service, Aeronautical, Television, F.M., Radar, and Marine telegraphy classes. Preparatory Course now forming. Literature upon request. Veteran training. Classes now forming for mid-year term February 2. Entrance examination January 12.

Dept. C, 38 West Biddle St., Baltimore 1, Md.

### RADIO COURSES

- RADIO OPERATING ● COGE
- RADIO SERVICING — ELECTRONICS
- REFRIGERATION SERVICING

Personal Counselling Services for Veterans  
Write for Latest Trade & Technical Catalog

**Y.M.C.A. TRADE & TECHNICAL SCHOOLS**  
4 W. 64th Street New York City

## CODE SENDING SPEED

Be a "key" man. Learn how to send and receive messages in code by telegraph and radio. Commerce needs thousands of men for jobs. Good pay, adventure, interesting work. Learn at home quickly through famous Candler System. Write for FREE BOOK.  
**CANDLER SYSTEM CO.**  
Dept. 3-O, Box 928, Denver 2, Colo., U. S. A.



# BOOK REVIEWS

**FUNDAMENTALS OF INDUSTRIAL ELECTRONIC CIRCUITS**, by Walther Richter. Published by McGraw-Hill Book Co. Stiff cloth covers, 6¼ x 9¼ inches, 569 pages. Price \$4.50.

The author has devoted a number of years to teaching industrial electronics in an evening school where students have widely differing educational backgrounds. Under these conditions, it was necessary to prepare and present his material so it would be easily understood by all. With this background experience, he prepared this book as a text to be used by all classes of students. It presents highly technical material clearly and with a minimum of mathematics.

The book contains 27 chapters, the first 10 being devoted to electrical and electronic fundamentals. The remaining chapters discuss various types of complete circuit elements that have applications in industrial control mechanisms. Each chapter concludes with a number of practical questions and problems, a list of suggested reading mate-

rial, and a bibliography of related reference material.

The manner in which the book is written and organized makes it equally useful to laymen, students, experimenters, and advanced engineers. This reader is glad to see that the author uses a large number of original diagrams as illustrations instead of going to the catalog of major equipment manufacturers for illustrative material as a number of recent authors on the subject have done.—*R.F.S.*

**A TREASURY OF SCIENCE**. Edited by Harlow Shapley, Samuel Rapport, and Helen Wright, with an introduction by Dr. Shapley. Published by Harper & Brothers. Stiff cloth covers, 6½ x 8½ inches, 772 pages. Price \$3.95.

This large work ranges from the role of genes in sex determination, to the whys and wherefores of atomic fission. It includes many original papers and reports of such famous scientists as Sir Issac Newton, Curie, Pasteur, Jeans, and Oppenheimer.

The articles are arranged in carefully edited groups, presenting a smooth-reading symposium on general science. The first group is titled "Science and the Scientist." The next selection of articles covers "The Physical World—The Heavens—The Earth—Matter, Energy, and Physical Law."

The evolution of life is well covered, including explanations by famous scientists on the Characteristics of Organisms—Where Life Begins—Life of the Simplest Animals—Warrior Ants—Darwin and the Origin of Species.

The section on the World of Man includes such subjects as "From the Ape to Civilization"—"Missing Links"—"You and Heredity"—"Biography of the Unborn"—"Conquest of Disease"—"History of the Kine Pox", and others.

Articles in the section on "Man's Mind" are "Thinking," "the Psychology of Sigmund Freud," and "Brain Storms and Brain Waves."

Atomic fission opens with the War Department's report on the New Mexico

tests. "Atomic Energy for Military Purposes," "Nuclear Physics and Biology," "The Atomic Bomb and International Relations" are other articles on the subject.

In other sections we find the original discourse on the law of gravity by Newton; "Notes on Zoology," by T. H. Huxley; "Secrets of the Ocean," by William Beebe; "Evidence of the Descent of Man from some Lower Form," by Charles Darwin; and "Exploring the Atom," by Sir James Jeans.

The general science student will find in this book answers to such questions as: What is atomic medicine? Is there life on other planets? What has the flight of bats to do with Radar? What is the role of the genes? How has Einstein's theory been substantiated? What are the laws of heredity?—*H.W.S.*

**A CAREER WITH A FUTURE!**

## TELEVISION

Shop Work • Shop Techniques • Theory  
FULLY EQUIPPED LABORATORIES

- RADIO SERVICE & REPAIR
- F. M. & TELEVISION
- TRANSMITTER COURSES

Preparing for F. C. C. LICENSES

- RADIO TECHNOLOGY

A Junior College Level Course preparing for positions in Radio-Electronic Engineering Field.

MORNING • AFTERNOON • EVENING CLASSES  
MODERATE RATES • INSTALLMENTS

Available Under G. I. Bill  
COME IN AND SEE OUR STUDENTS AT WORK

### DELEHANTY SCHOOL OF

RADIO • ELECTRONICS • TELEVISION  
105 EAST 13 ST., N. Y. 3, N. Y. • DEPT. R  
LICENSED BY STATE OF NEW YORK

**Amazing! POCKET OR PURSE SIZE**

## NEW RADIO

WORLD'S SMALLEST RADIO KNOWN!  
Wt. only 1 lb. Beautiful Silver Black plastic case. Has inductive Slide Tuner—W4 Crystal Diode—NO TUBES, BATTERIES OR ELECTRIC PLUG IN! WEEDS! Should last for years!

**GUARANTEED TO PLAY** NEW 1948 MODEL

on local stations if complete instructions sent are followed. Use it at home, in bed, in many offices, hotels, cabins—most anywhere! HUNDREDS OF SATISFIED CUSTOMERS ALL OVER THE WORLD!

**SEND ONLY \$1.00** (Cash, M.O. Check) and pay postman \$2.99 plus delivery fees on arrival or send \$3.99 for Post Paid delivery. Complete as shown—ready to play with self contained personal phone. WONDERFUL GIFTS FOR CHILDREN! Order now at this low bargain price—Prompt shipment on orders sent now—today! Be the first to get YOUR Pocket Radio! (All foreign orders \$5.00 U. S. cash with order).

**Pe-Kette Radio Co., Inc. Dept. RC-12 Kearney, Nebr.**

## KEY TO A PRACTICAL UNDERSTANDING OF ELECTRICITY

1440 PAGES  
2600 ILLUS.

**PRICE \$4 COMPLETE**

- AUDEL'S HANDY BOOK OF ELECTRICITY for Maintenance Engineers, Electricians and All Electrical Workers. A quick, simplified, ready reference handy book, giving complete instruction and practical
- INSIDE TRADE INFORMATION ON rules and laws of electricity—maintenance of electrical machinery—A.C. and D.C. motors—armature winding and repair—wiring diagrams—house wiring—power wiring—cable splicing—meters—batteries—transformers—elevators—electric cranes—railways—bells—sign flashers—telephone—ignition—radio principles—refrigeration—air conditioning—oil burners—air compressors—welding and many modern applications explained so you can understand.

All indexed for ready reference.

To get this assistance for yourself, simply fill in and mail the FREE EXAMINATION COUPON below.

AUDEL, Publishers, 49 W. 23 St., NEW YORK 10, N. Y.

Please send me "Audel's Handy Book of Practical Electricity" for free examination. If satisfactory, I will send you \$1 in 7 days, then \$1 monthly until \$4 is paid. Otherwise I will return it.

Name \_\_\_\_\_  
Address \_\_\_\_\_  
Occupation \_\_\_\_\_  
Employed by \_\_\_\_\_ RCF

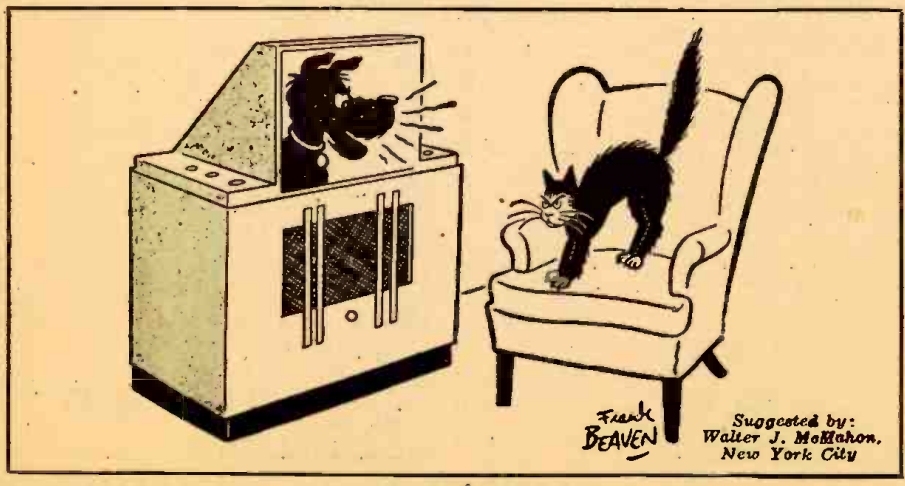

# FREE

UP TO THE MINUTE  
BUYING  
INFORMATION

Radio Repair Parts  
Sound Systems • Tools  
Kits • Phono Equipment  
Tubes • Test Instruments  
Experimenters Supplies

REGULAR SUPPLEMENTS  
KEEP YOU POSTED

Catalog sent immediately upon request. Price and Data Supplements, issued regularly, assure you of up-to-the-minute information—give exact and current data you need for profitable buying. Send the coupon today for this helpful buying service.

BIG VALUES, LARGE STOCKS,  
FAST, DEPENDABLE SERVICE.



FREE... SEND TODAY

RADOLEK CO., Dept. C-127  
601 W. Randolph St., Chicago 6, Ill.  
Please send your Free Profit Guide Catalog and regular Supplements.

Name .....  
Address .....  
City ..... Zone ..... State .....

SAVE AT RADOLEK

Ship-to-Shore  
Radio Telephones  
for Boats

Western  
Electric, Navy  
T.C.S., RCA,  
Jefferson Travis  
and Harvey  
Wells, From \$75  
up.

Transvision  
Kits, 12" and 7"  
Kits available  
for immediate  
shipment.

Coaxial cable  
for  
Television,  
Rg5U \$5.00 per  
100.  
double wire, 92  
ohm, \$7.50 per  
100.

Latest Pilot  
Tuner for FM  
\$29.95.

Headphones  
H.S. 30 \$9.8 ea.  
Army phones  
with cushions,  
\$1.50.

Record Chang-  
ers, Webster 56  
Automatic stop  
\$24.95.  
Seebug 2 post  
—\$21.50.

Detrola—\$14.50.  
Write for prices on  
all other types.

All tubes are standard brands in cartons.  
If not rated 25% with order, balance C.O.D. All  
prices F.O.B. our warehouse New York. No order  
under \$2. We ship to any part of the globe.  
**SUPERIOR RADIO CO.**  
123 Barclay St., New York, N. Y.

## INDEX TO ADVERTISERS

A. M. Radio Sales Company.....	90	National Plans Company.....	91
Bergman-Jarrett Co.....		National Radio Institute.....	1
Abell Distributing Company.....	83	Van Sant, Dugdale & Company.....	9
Brodix Advertising Agency.....		National Schools.....	9
Air King.....	Back Cover	The Mayers Company.....	
Myron Jonas Company.....		Newark Electric Company.....	80
Allied Radio Corporation.....	60	Bergman-Jarrett Co.....	81
George Brodsky Advertising.....		Niagara Radio Supply.....	
Almo Radio Company.....	86	Bergman-Jarrett Co.....	52
H. Lesseroux Advertising.....		Olson Radio Warehouse.....	52
American Condenser Company.....	79	Jessop Advertising Company.....	88
Campbell, Reynolds & Evans.....		Opportunity Adlets.....	95
American Surplus Products.....	69	Pa-Kette Radio Company.....	
Gary A. Ruben, Advertising.....		Arrow Advertising Agency.....	51
American Television, Inc.....	11	Pilot Radio Corporation.....	91
Turner Advertising Agency.....		Alfred Paul Berger Company.....	91
Amplifier Corporation of America.....	74, 85, 89	Potter Radio Company.....	91
H. J. Gold Advertising.....		Precision Apparatus Company.....	89
Apex Video Company.....	85	Shappe-Wilkes, Inc.....	89
Anderson & McConnell Advertising.....		Precision Electronics, Inc.....	14
Walter Ashe Radio Company.....	74	Campbell, Reynolds & Evans.....	
Ralph W. Smith Advertising Agency.....		Progressive Electronics Company.....	
Audel Publishers.....	95	Thomson, Seva & Valenti, Inc.....	
Grant & Wedsworth, Inc.....	16		
Bell Telephone Labs.....			
N. W. Ayer & Son.....	45		
Belltone Radio & Television Corp.....			
Edwin Freed Advertising.....			
Boland & Boyce, Inc., Publishers.....	3, 47		
Shappe-Wilkes, Inc.....			
Bonafide Radio Company.....	82		
Bergman-Jarrett Co.....	91		
Bradshaw Instrument Company.....	83		
Brooks Radio Distributing Company.....	93		
Equity Advertising Agency.....			
Buffalo Radio Supply.....	58, 59		
International Advertising Agency.....			
Burstein-Applebee Company.....	90		
Frank E. Whelan Advertising Company.....			
Buyers' Syndicate.....	86		
C. B. Mfg. Co.....	77		
Capitol Radio Engineering Institute.....	45		
Henry J. Kaufman & Associates.....			
Certified Television Laboratories.....	89		
Cleveland Institute of Radio.....	53		
Kenneth Kolpein Advertising.....			
Commercial Radio.....	78		
Goulston Company, Inc.....	6		
Communications Equipment Company.....	89		
Borough Advertising Agency.....			
Concord Radio Corporation.....	93		
E. H. Brown Advertising.....	90		
Constant Electric.....			
Coyne Electrical School.....			
Gordon Best Co., Inc.....	46		
Coyne Electrical School.....	86		
Phil Gordon Advertising Agency.....			
Deer & Taylor.....	7		
Spencer W. Curtiss Advertising.....			
DeForest's Training Institute.....	92		
Lauesen and Salomon.....			
Electronics Company of Staten Island.....	12, 13, 66, 67		
Esso Radio Company.....			
Gary A. Ruben Advertising.....	86		
General Cement Manufacturing Company.....	41, 43, 69		
Sander Rodkin Agency.....			
General Electronic Distributing Company.....	76		
Bass & Company, Inc.....	89		
General Research Labs.....	86		
Schank Advertising.....			
General Test Equipment Company.....	91		
Suzanne Hayman Advertising.....			
Greylock Electronic Supply Co.....	84		
Bergman-Jarrett Co.....	92		
Hallmark Electronic Corporation.....	61		
The Norman W. Henley Publishing Company.....			
Hershel Radio Company.....	90		
Hugh Allen Company.....	87		
Hotel Strand.....	91		
Hudson Specialties.....	92		
Illinois Condenser Company.....	78		
Kuttner & Kuttner Advertising.....			
Instructograph Company.....	83		
Turner Advertising Agency.....			
Insuline Corporation of America.....	84		
S. R. Leon Company, Inc.....			
International Resistance Company.....			
	Inside Front Cover		
John Falkner Arndt & Co., Inc.....	64		
Manuel Klein.....	77		
Sternfield-Godley, Inc.....	87		
Lafayette Radio.....	42		
Reiss Advertising Agency.....	78		
Leads Radio Company.....	73		
Weber Associates.....	2		
Leonard Radio, Inc.....	84		
Sternfield-Godley, Inc.....			
Leotone Radio Corporation.....	91		
Altomari Advertising Agency.....			
McMurdo Silver Company.....	75		
Edward Owen & Company.....			
P. R. Mallory & Co., Inc.....	72		
Aitkin-Kynett Company.....	63, 79		
Maritime Switchboard.....			
Merit Products.....	75		
Metropolitan Electronic & Instrument Co.....			
Bass & Company, Inc.....			
Midwest Radio Corporation.....			
Seavage and Talley.....			
Moos Electronic Distributing Co.....	65, 71		
Bass & Company, Inc.....			
Murray Hill Books, Inc.....	8		
Harry P. Bridge, Inc.....			
National Company.....			
John A. Cairns & Co., Inc.....			

### RADIO SCHOOL DIRECTORY (See Pages 94, 95)

American Radio Institute.....	
Sternfield-Godley, Inc.....	
Baltimore Technical Institute.....	
Candler System Company.....	
Rand-Ries Advertising.....	
Commercial Radio Institute.....	
Deleahy Institute.....	
Devinc Adv. Agency, Inc.....	
Lincoln Engineering School.....	
Buchanan-Thomas Advertising.....	
Don Martin School of Radio Arts.....	
Grant Advertising, Inc.....	
Melville Radio Institute.....	
Seidell Advertising.....	
Milwaukee School of Engineering.....	
Klau-Van Pietserson-Dunlap Associates.....	
Radio-Television Institute.....	
Richmond Advertising Service.....	
RCA Institutes.....	
Tri-State College.....	
Clem J. Steigmeyer Advertising.....	
Western Radio Communications Institute.....	
N. J. Newman Advertising Agency.....	
YMCA Trade & Technical Schools.....	
Cecil & Presbrey, Inc.....	

Radio Corporation of America.....	Inside Back Cover
J. Walter Thompson Company.....	
Radio-Craft.....	76, 80
Radio Dealers Supply Company.....	70
Radio Equipment Company.....	91
Radio Kits Company.....	78
Edward Hamburger Advertising Company.....	
Radionic Equipment Company.....	93
Republic Advertising Agency.....	
Radio Publications.....	93
Radio Supply and Engineering Company.....	55
Karl G. Behr Advertising Agency.....	
Radolek Company.....	96
Campbell, Reynolds & Evans.....	
Ravac Electronics Corporation.....	91
Reed Manufacturing Company.....	91
Borg Advertising Agency.....	
John F. Rider Publisher, Inc.....	4
Lansford F. King Advertising.....	
The Rosticrucians.....	83
Richard Jorgensen.....	
Howard W. Sams Company, Inc.....	49
George Brodsky Advertising.....	
Walter L. Schott Company.....	81
Ross, Gardner & White.....	
Schuh's Radio Parts.....	64
The Schram Advertising Company.....	
Senco Radio, Inc.....	88
Sternfield-Godley, Inc.....	
Sprayberry Academy of Radio.....	5
E. H. Brown Advertising.....	
Sterling Electronic Company.....	83
Superior Radio Company.....	96
Supreme Instruments Corporation.....	70
O'Callaghan Advertising Agency, Inc.....	
Supreme Publications.....	57
Henry H. Teplitz Advertising.....	
Telectronics.....	64
Burke-Wayburne Adv.....	
Tradio, Inc.....	93
George M. Hakim Advertising.....	
Transvision, Inc.....	60, 68
H. J. Gold Advertising.....	
Triplet Manufacturing Company.....	48
Western Advertising Agency.....	
The Turner Company.....	50
W. D. Lyon Company.....	
Ungar Tools.....	60
Lindeke Advertising Agency.....	
Universal General Corporation.....	91
Gelles Advertising Agency.....	
University Loudspeakers, Inc.....	72, 85
George Homer Martin Associates.....	
Variety Electric Company.....	62
Bass & Company, Inc.....	
Welter Manufacturing Company.....	40
Beaumont, Heller & Sperling Advertising.....	
Wright, Inc.....	77
Key Advertising, Inc.....	
X. L. Radio Laboratories.....	83



*Your enjoyment climbs to new altitudes through radio and television achievements of RCA Laboratories.*

## ***RCA LABORATORIES—your "magic carpet"***

### ***to new wonders of radio and television***

More and more people will go sight-seeing by television as the number of stations and home receivers increases. Eventually, television networks will serve homes from coast to coast . . . bringing you the news as it happens . . . sports events . . . drama . . . vaudeville.

Many of the advances which have made possible these extended services of radio-electronics, in sound and sight, originated in research conducted by RCA Laboratories.

Recent RCA "firsts" include: ultra-sensitive television cameras that give startling clarity to all-electronic television . . . tiny tubes for compact, lightweight portable radios . . . "picture tube" screens for brilliant television reception.

In other fields of radio-electronics, RCA has pioneered major achievements—including the electron microscope. Research by RCA Laboratories goes into every product bearing the name RCA or RCA Victor.

#### **PIONEERING**

Scientists and research men who work in RCA Laboratories made many vital contributions in helping to win the war through application of radio, electronic, radar and television techniques. Their skills now are devoted to peacetime applications of these sciences.

At RCA Laboratories the electron microscope, radar, all-electronic television (featuring the projection system for the home) and many other new instruments of radio, including hundreds of new electron tubes, were developed to improve and to extend the services of radio around the world.



**RADIO CORPORATION of AMERICA**

*a portable*  
**RADIO-CAMERA!**

**AIR KING'S**  
*2 in 1* portable  
*Revolutionizes*  
 the PORTABLE RADIO FIELD

**another AIR KING SCOOP**

Right on the heels of the Wire Recorder, AIR KING follows through with another winner . . . . . the AIR KING RADIO-CAMERA (2 in 1) portable. Here is an exclusive new AIR KING innovation . . . America's first Radio-Camera . . . completely new . . . and different.

The ability of AIR KING to produce the unusual in radios is well known. The country's most successful merchandisers have followed AIR KING'S leadership for the past 27 years.

The Radio-Camera is an important contribution to the radio dealer . . . today . . . when he needs it most!



**AIR KING RADIO-CAMERA MODEL A410**  
 SIZE: Height 9½"; Width 4¾"; Depth 3¾"  
 WEIGHT: Less than 4 lbs. complete with batteries.  
 RADIO: Superheterodyne with latest type miniature tubes.  
 BATTERIES: 2, flashlight type "A"  
 1, 67½ Volt "B" Battery

**CAMERA**  
 Everready Camera Case; 50mm. Meniscus Lens, time and instantaneous exposures. Takes black and white or color pictures; #828 Standard Film.  
 Adjustable strap for shoulder or hand carry.

MODEL A410

**29<sup>95</sup>**  
 RETAIL  
 LESS  
 BATTERIES

★ For quick action write or wire Air King Products Co.  
 170 - 53rd Street, Brooklyn, New York  
 Export Address: Air King International, 75 West Street, New York 6, New York

*The Royalty of Radio Since 1920* **AIR KING RADIO.** Division of HYTRON RADIO & ELECTRONICS CORP.